

- [54] **BED**
- [75] **Inventor: Vernon L. Goodwin, Charlotte, N.C.**
- [73] **Assignee: Support Systems International, Inc., Charleston, S.C.**
- [\*\*] **Term: 14 Years**
- [21] **Appl. No.: 571,559**
- [22] **Filed: Jan. 17, 1984**
- [52] **U.S. Cl. .... D6/390**
- [58] **Field of Search ..... D6/390, 382, 383, 391, D6/392, 331; 5/445, 453, 47**

[56] **References Cited**  
**U.S. PATENT DOCUMENTS**

D. 49,793	10/1916	Biel .....	D6/386
D. 137,982	5/1944	Lanese .....	D6/390
D. 146,865	6/1947	Maxwell .....	D6/391
D. 247,307	2/1978	Johansson .....	D6/390 X
D. 251,518	4/1979	Boudreau et al. ....	D6/386
D. 266,209	9/1982	Rogers .....	D6/386
530,858	12/1894	Shortill .....	5/425 X
1,130,948	3/1915	Wendling .....	5/445 X
1,618,493	2/1927	Thiele .....	D6/386 X
3,742,527	7/1973	Johnston et al. ....	D6/392 X

*Primary Examiner*—Bernard Ansher  
*Assistant Examiner*—Linda Titolo  
*Attorney, Agent, or Firm*—Dority & Manning

[57] **CLAIM**

The ornamental design for a bed, as shown and described.

**DESCRIPTION**

FIG. 1 is a top front perspective view of a bed, showing my new design;  
FIG. 2 is a top plan view of the bed member of FIG. 1 shown separately for clarity of illustration;  
FIG. 3 is a right side elevational view of that shown in FIG. 1 with one side rail member in an alternate position, the left side view being a mirror image thereof;  
FIG. 4 is a front elevational view of the bed member of FIG. 1, shown separately for clarity of illustration, the rear view being a mirror image thereof;  
FIG. 5 is a right side elevational view of that shown in FIG. 1, the left side view being a mirror image thereof;  
FIG. 6 is a front elevational view thereof, the rear view being a mirror image thereof; and  
FIG. 7 is a top plan view thereof.  
Opposite views of the bed as illustrated in the figures would be as shown in the Figures.

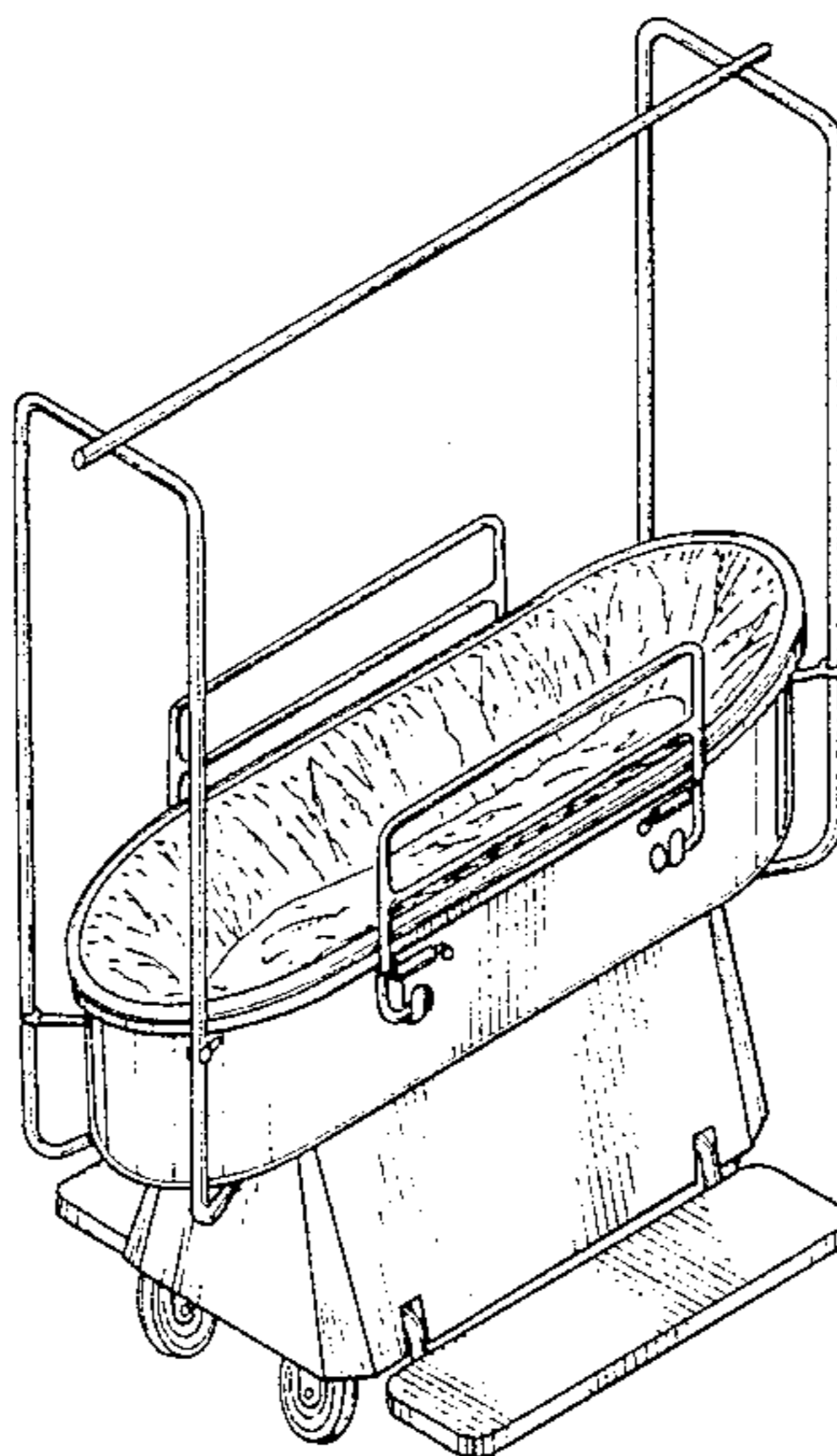

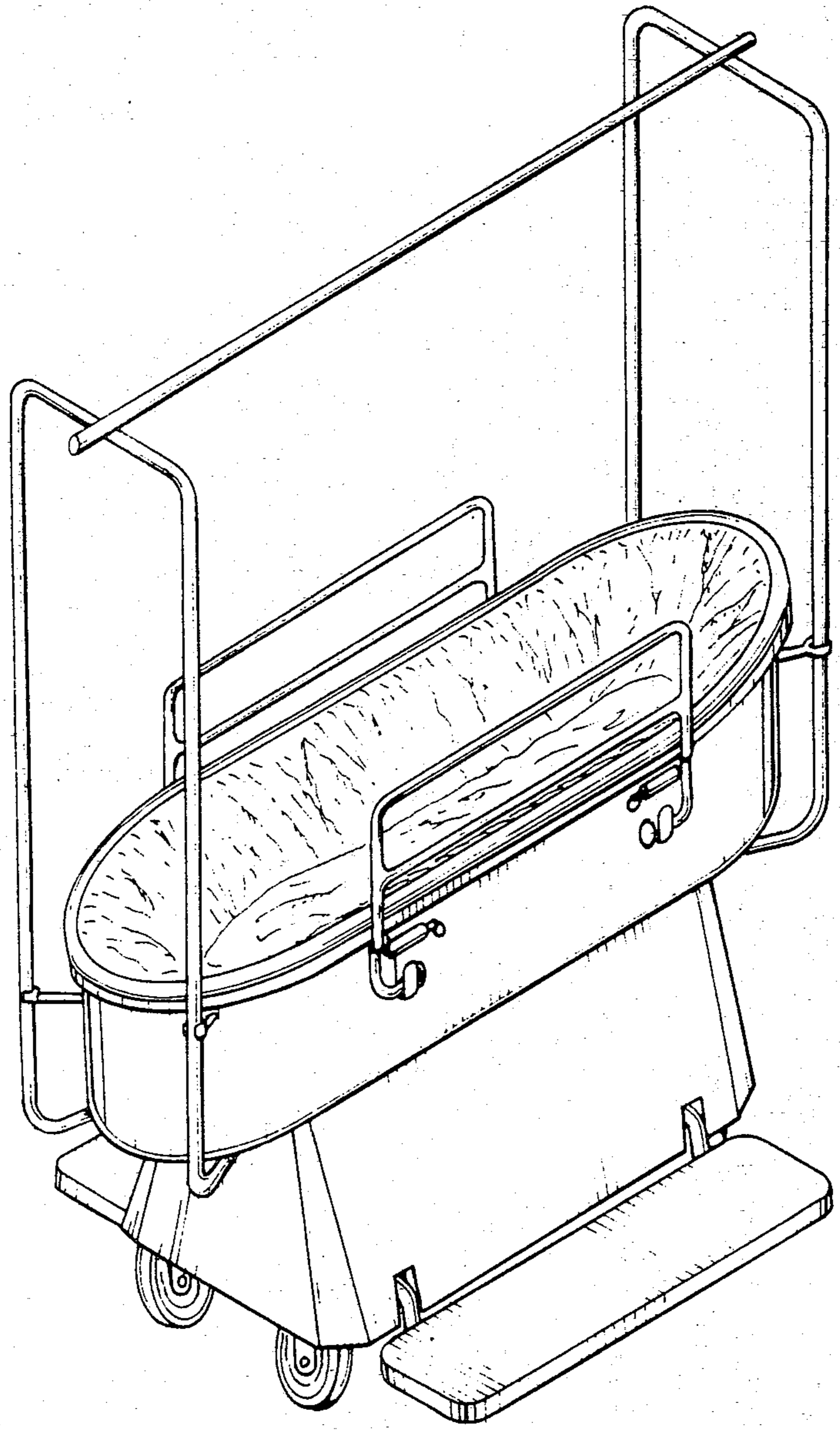

FIG. 1.

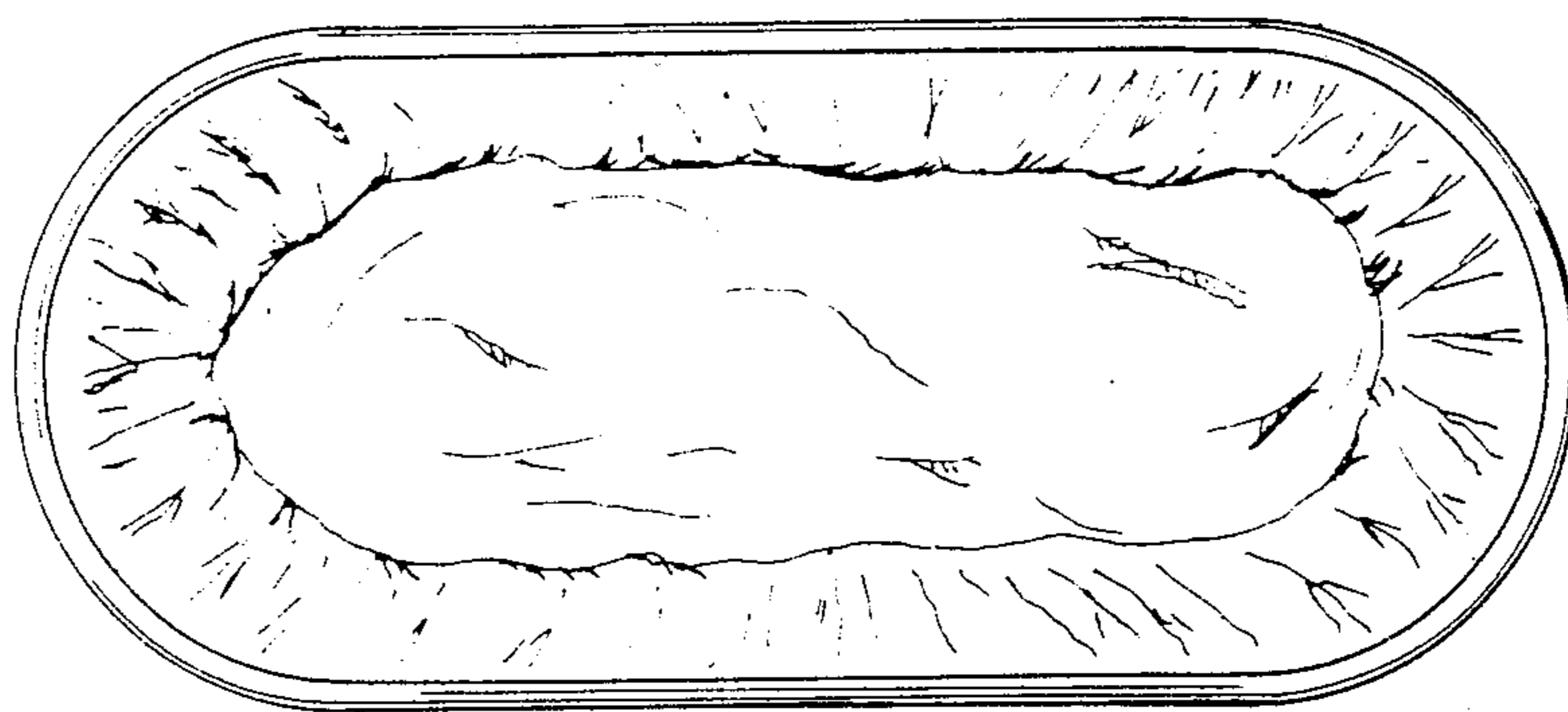

FIG. 2.

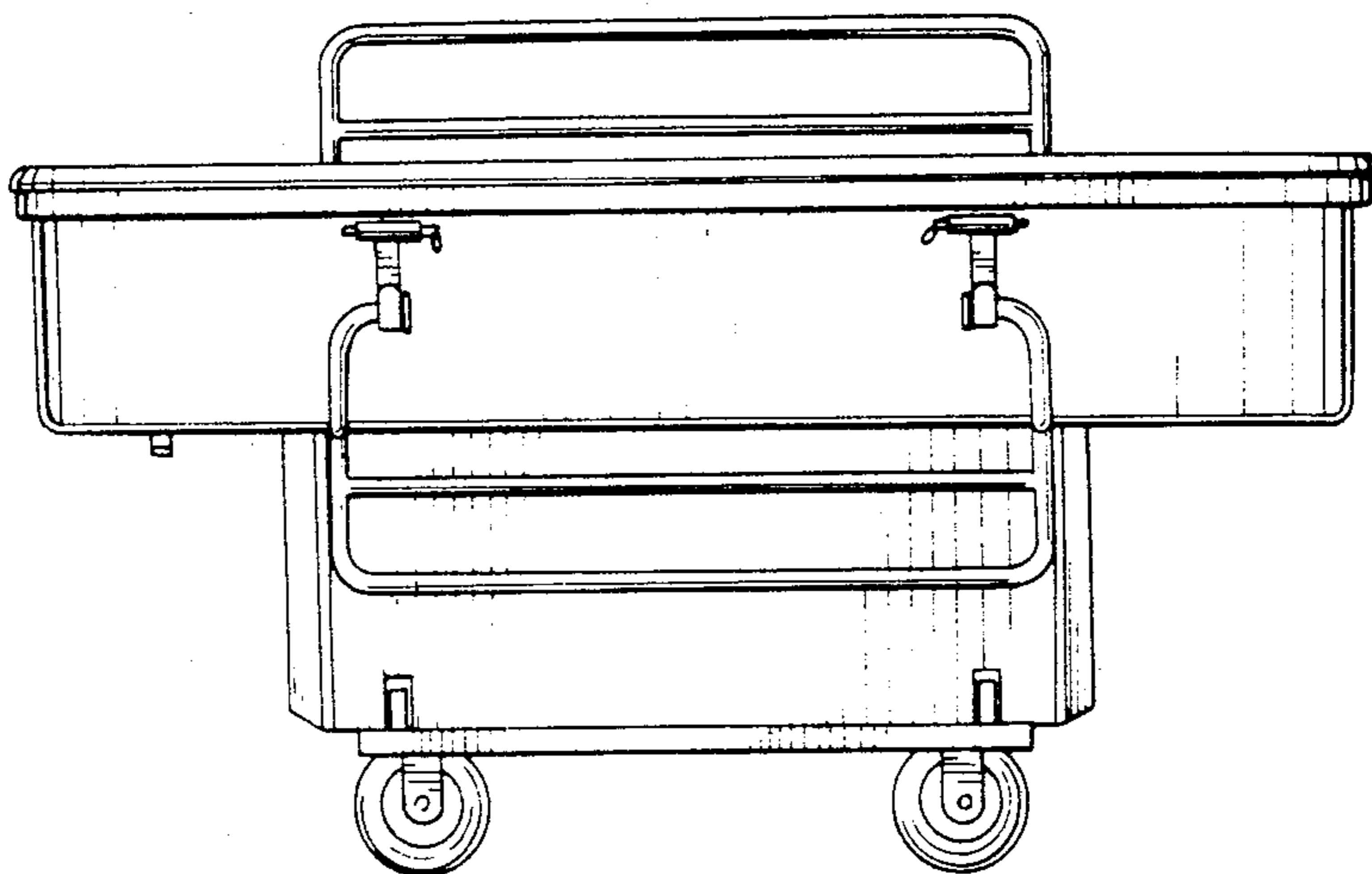

FIG. 3.

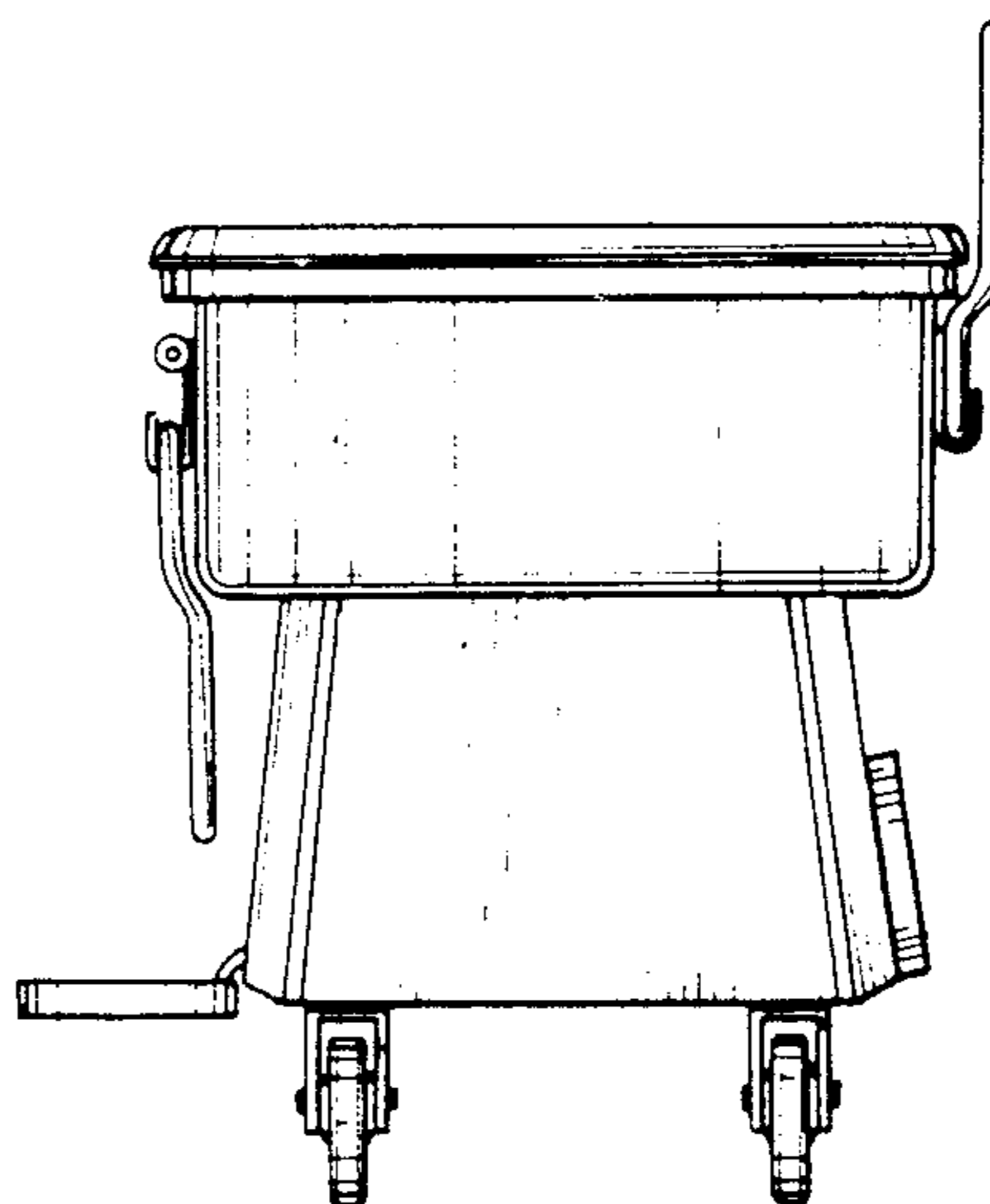

FIG. 4.

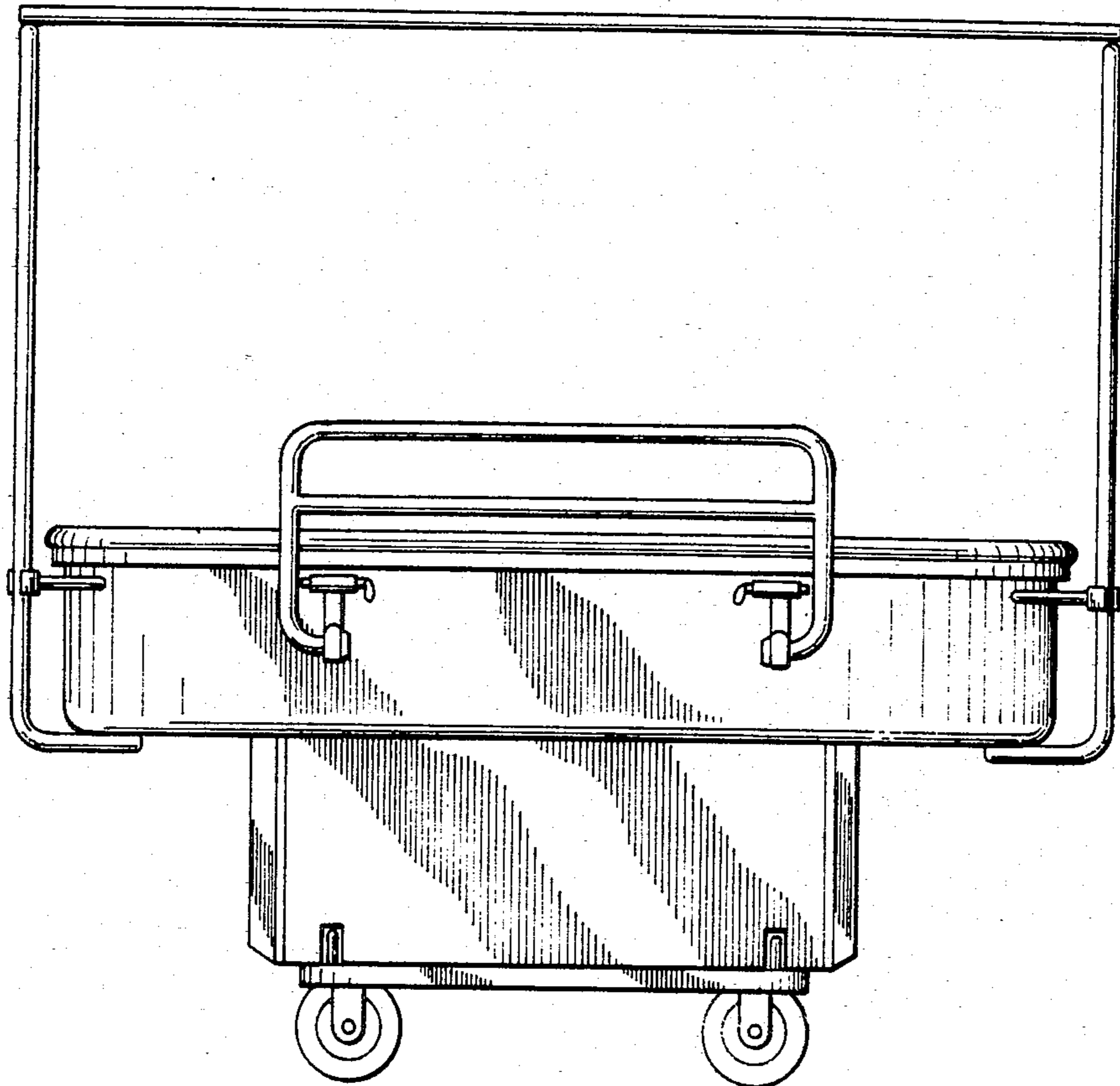

FIG. 5.

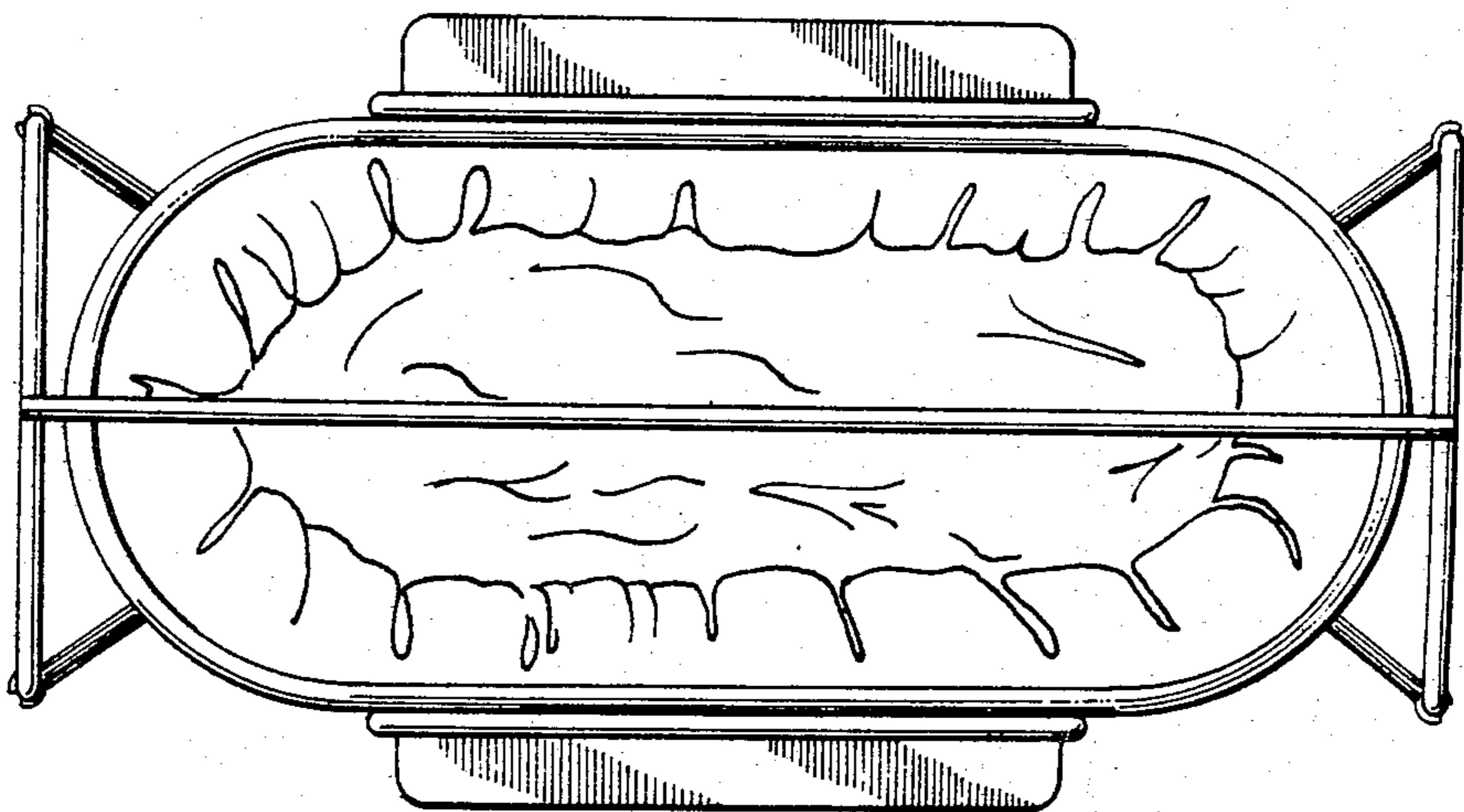

FIG. 7.

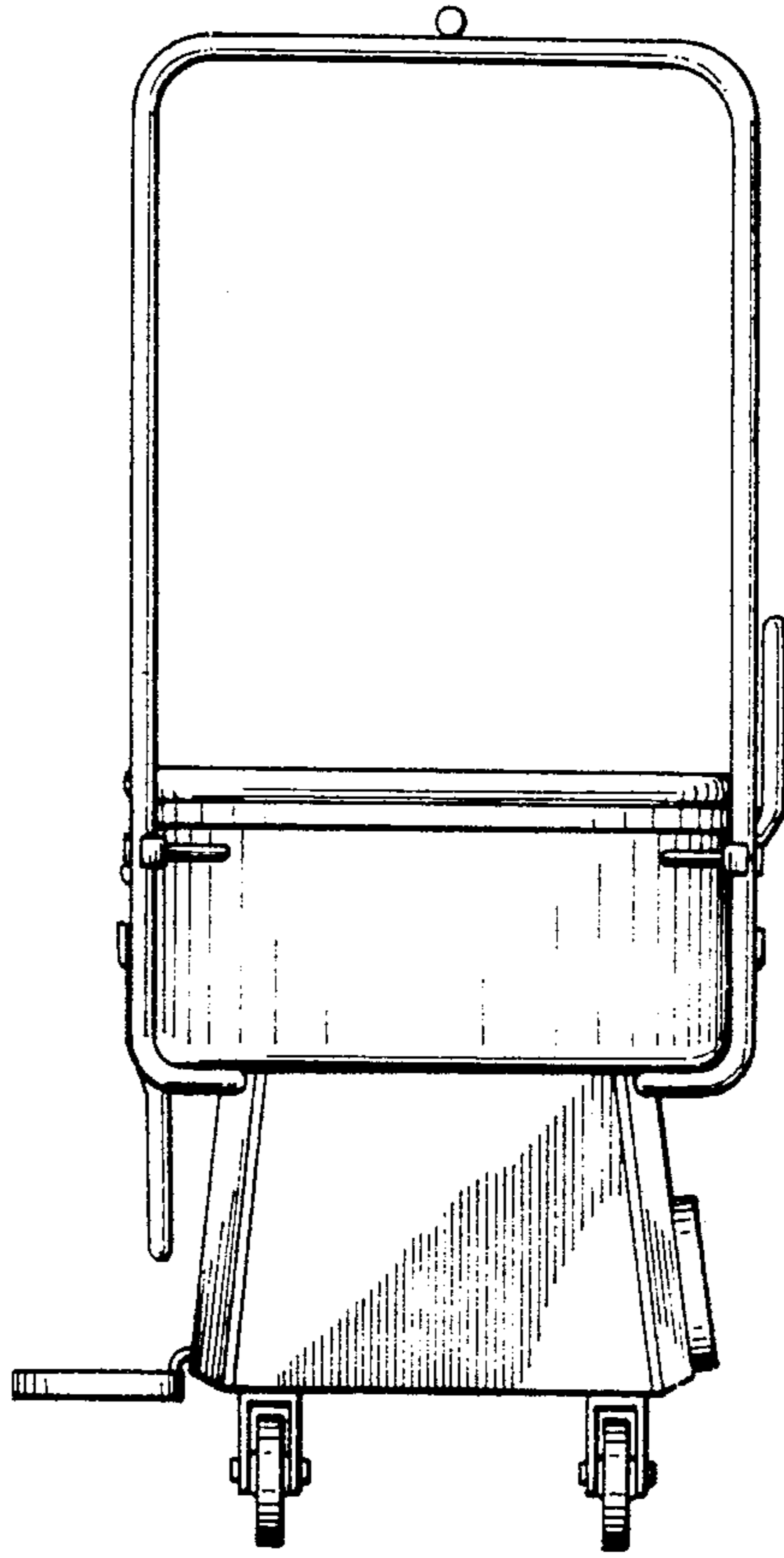

FIG. 6.