

[54] TELEPHONE SUPPORT STAND

4,073,460 2/1978 Dale D18/12 X

[76] Inventor: Kendall L. Miller, 93 Hickory St., Apt. 2, Rochester, N.Y. 14620

[**] Term: 14 Years

[21] Appl. No.: 710,619

[22] Filed: Mar. 11, 1985

[52] U.S. Cl. D14/60; D14/65

[58] Field of Search D14/60, 65, 59; D6/314, D6/476, 449, 35, 432, 418; D18/11, 12; D19/90, 91; 179/146 R, 147, 179, 100 R, 100 D

[56] References Cited

U.S. PATENT DOCUMENTS

D. 26,026	9/1896	Ferber	D19/92 X
D. 88,820	12/1932	Parker	D6/419
D. 149,121	3/1948	Golden	D6/314
D. 191,165	8/1961	Dellaguardia	D14/65
D. 256,869	9/1980	Arnone	D19/91 X
D. 262,499	1/1982	Berth	D6/449 X
D. 275,206	8/1980	Fineout	D19/91 X
D. 277,664	2/1985	Wilt	D14/60
D. 278,109	3/1985	Leeds	D19/91 X
1,197,736	9/1916	Hartford	D6/476 X

OTHER PUBLICATIONS

Popular Science, Sep. 1976; Holder for Handset Telephone.

New Product; OA-Jan. 1960 at p. 56, "Vision-Aid" Copy Holder.

Primary Examiner—Wallace R. Burke

Assistant Examiner—Horace B. Fay

Attorney, Agent, or Firm—Bruns and Wall

[57] CLAIM

The ornamental design for a telephone support stand, and described.

DESCRIPTION

FIG. 1 is a front, top and partial right side perspective view of a telephone support stand showing my new design;

FIG. 2 is a front elevation thereof;

FIG. 3 is a top plan view thereof;

FIG. 4 is a bottom plan view thereof;

FIG. 5 is a right side elevation thereof, the left side elevation being a mirror image; and

FIG. 6 is a rear elevation thereof.

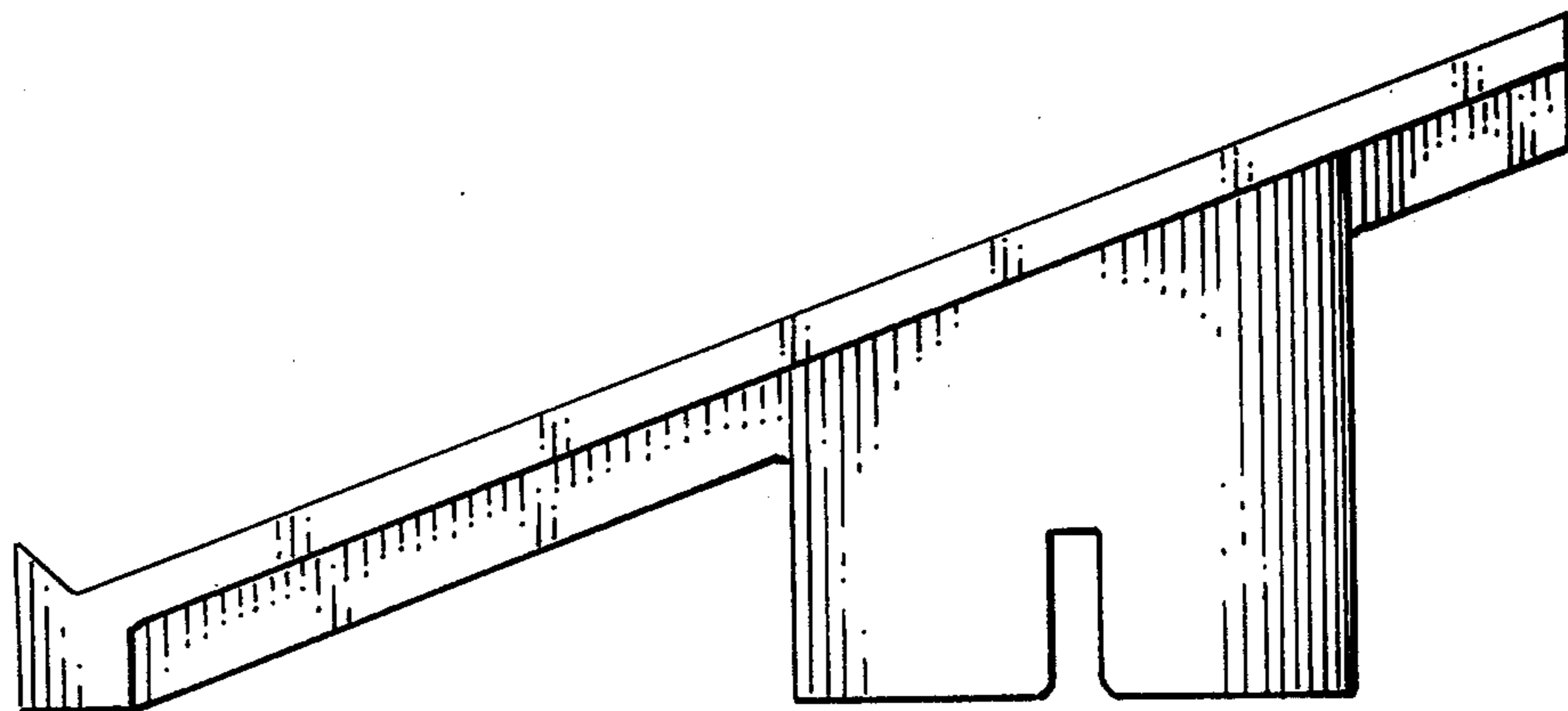
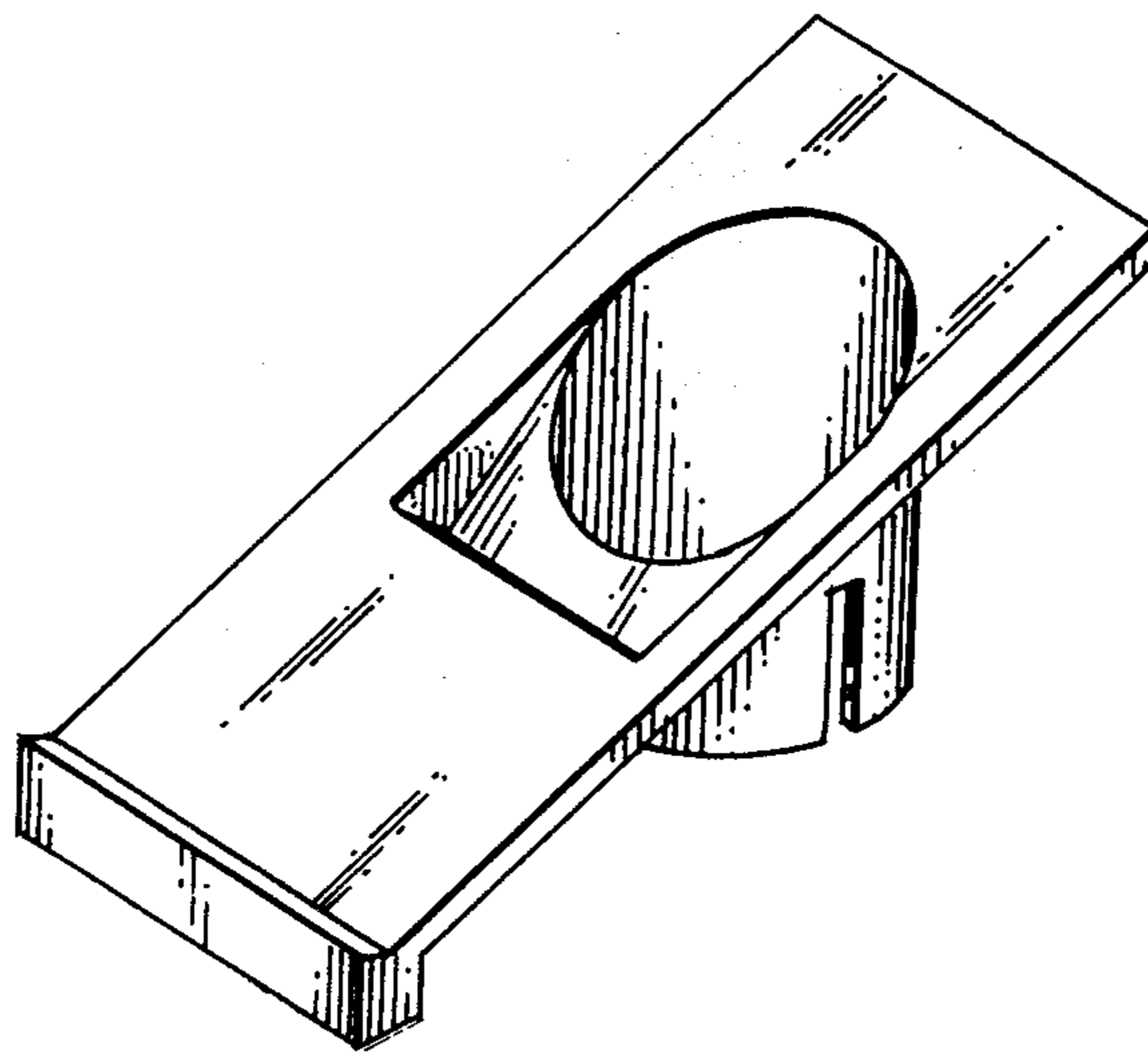

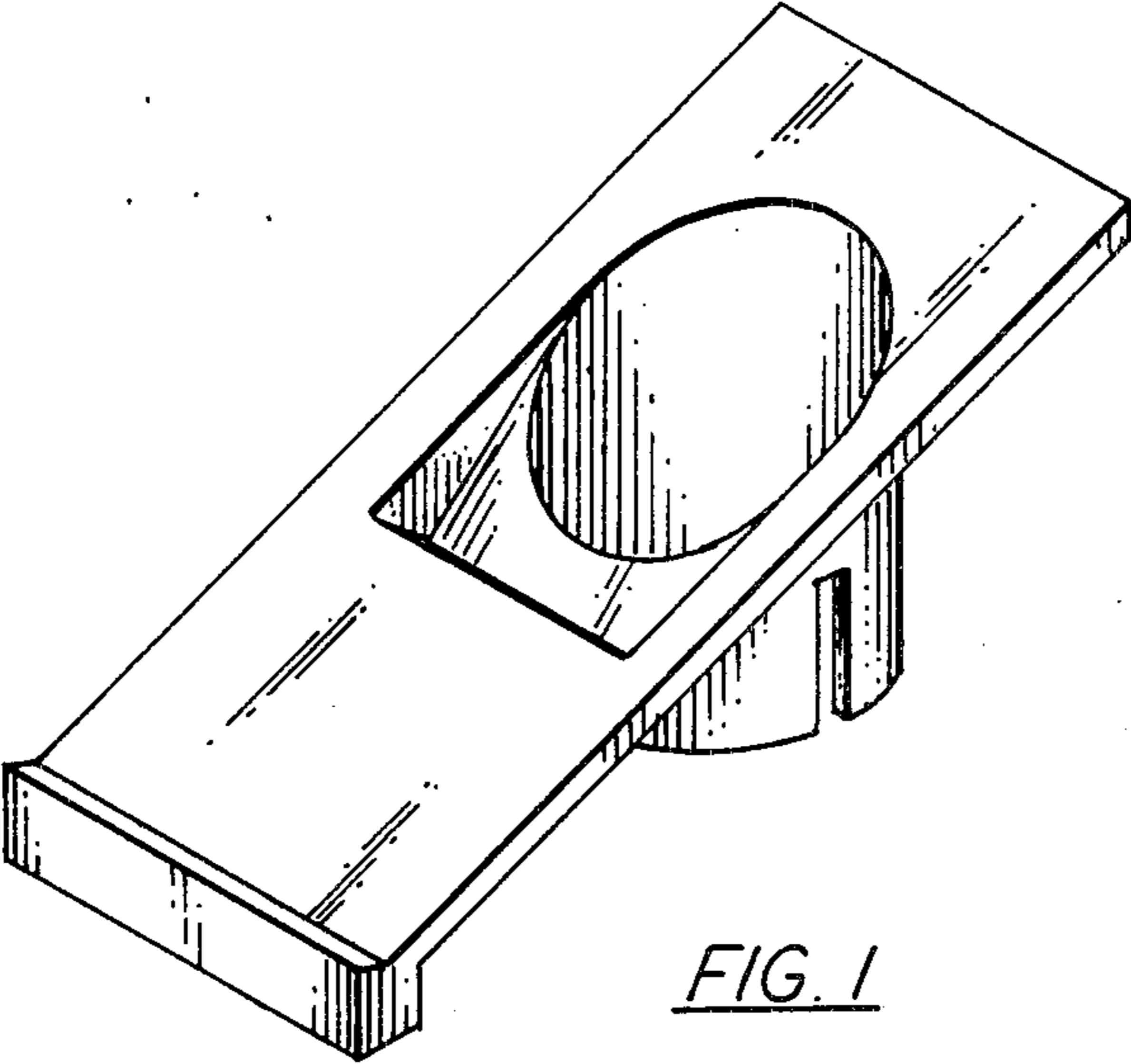

FIG. 1

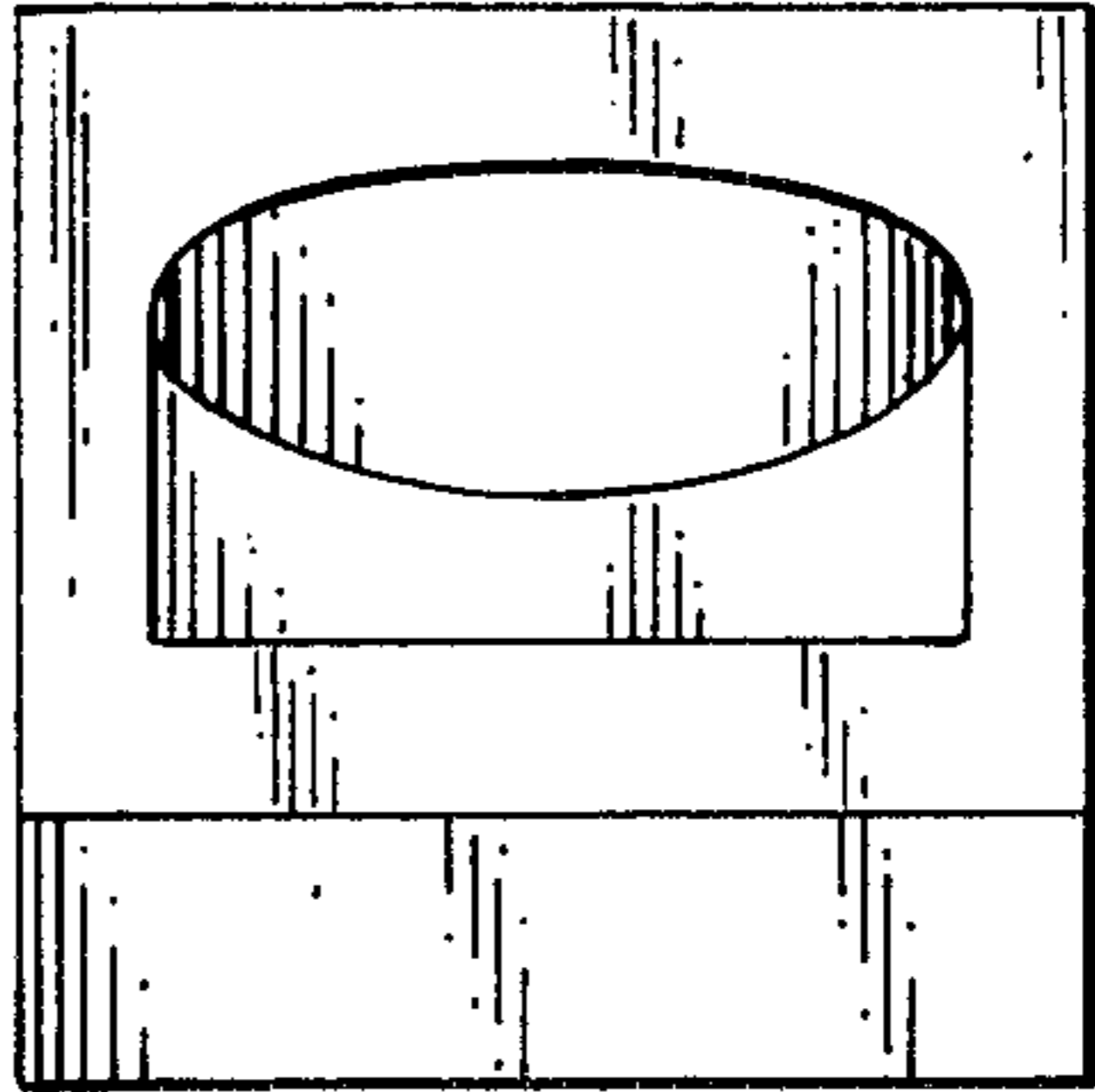

FIG. 2

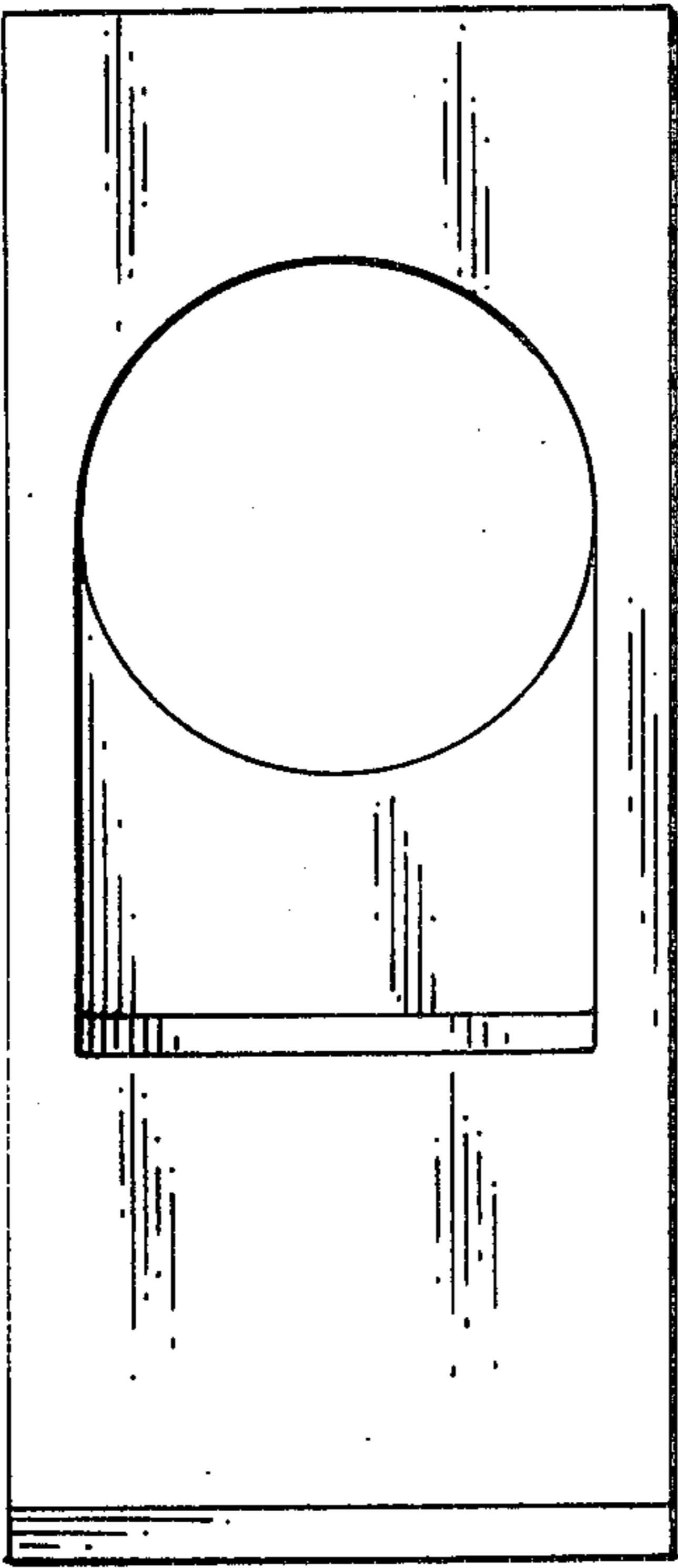

FIG. 3

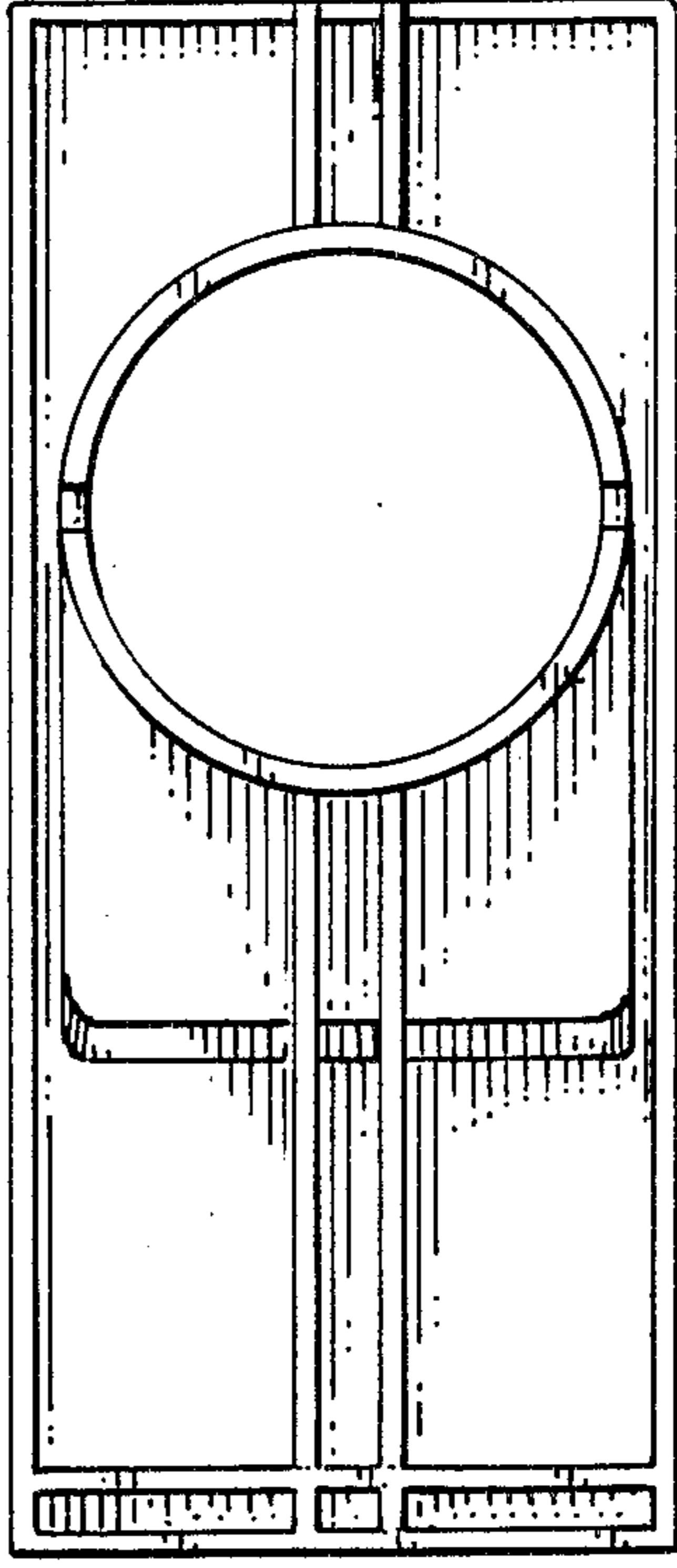

FIG. 4

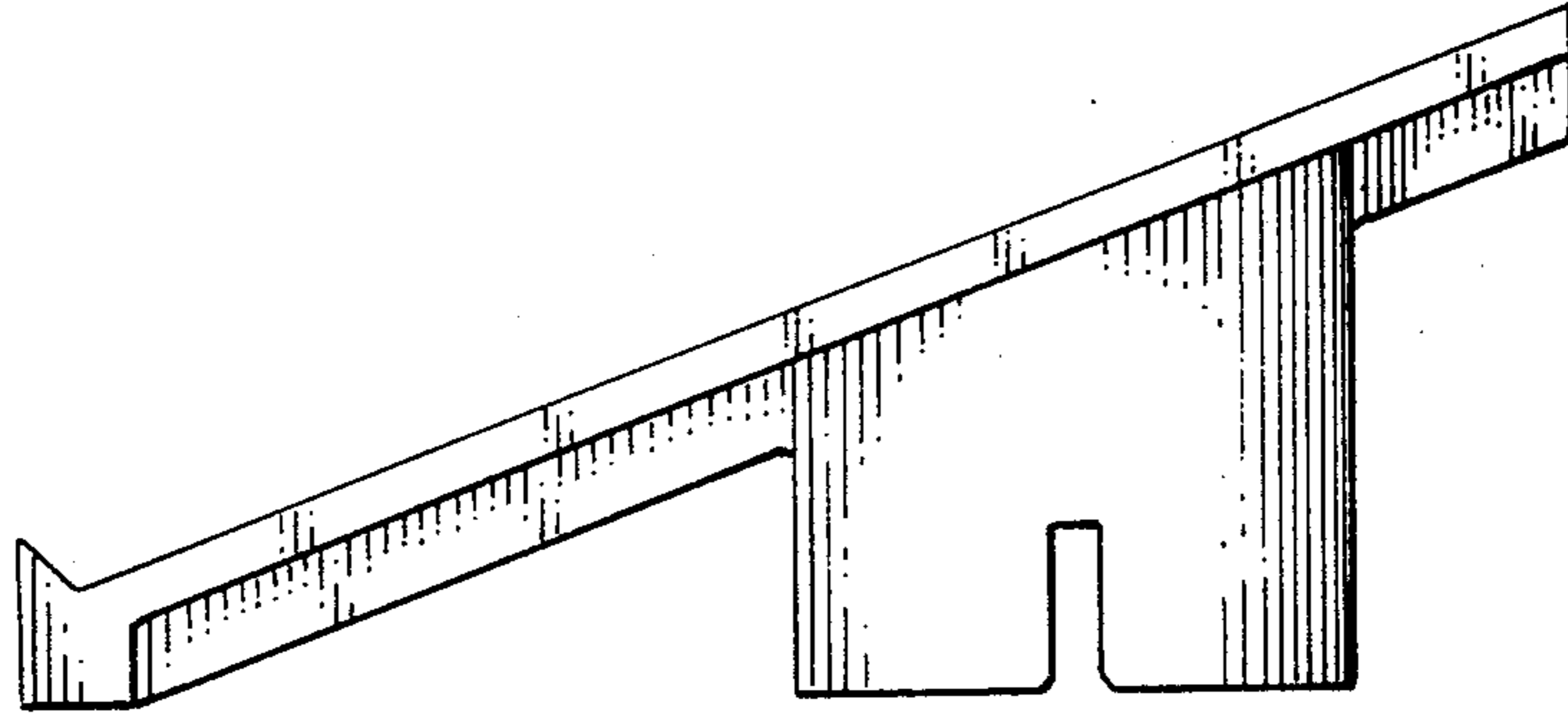

FIG. 5

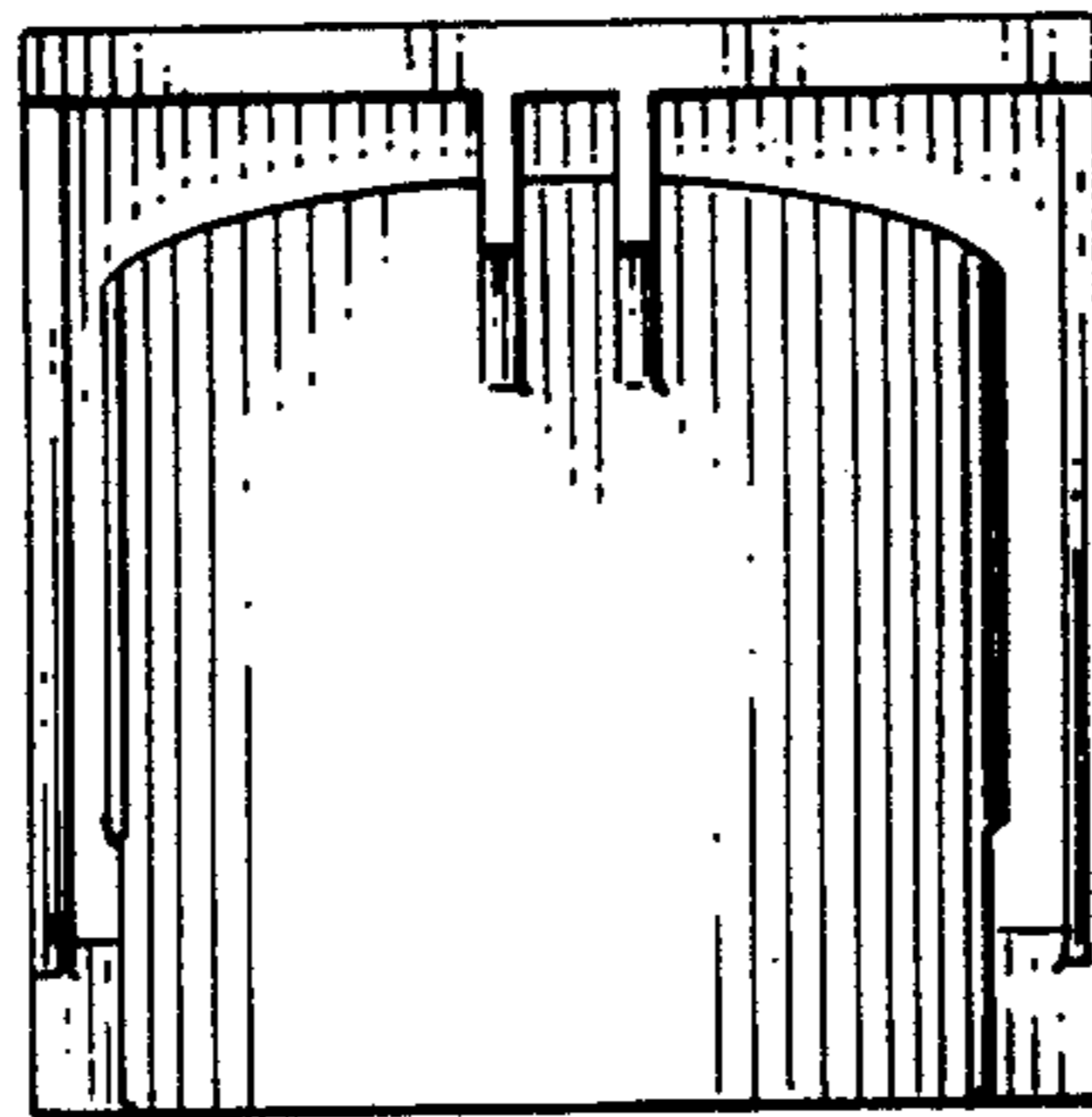

FIG. 6