

[54] CAMERA

[75] Inventor: Luigi Colani, Sassenberg, Fed. Rep. of Germany

[73] Assignee: Canon Kabushiki Kaisha, Tokyo, Japan

[\*\*] Term: 14 Years

[21] Appl. No.: 708,418

[22] Filed: Mar. 5, 1985

[30] Foreign Application Priority Data

Oct. 5, 1984 [JP] Japan ..... 59-41617
[52] U.S. Cl. .... D16/6; D16/2
[58] Field of Search ..... D16/1-10; 354/82, 81, 202, 288, 149.11, 126, 127.1, 127.11, 145.1

[56] References Cited

U.S. PATENT DOCUMENTS

D. 41,894 11/1911 Sommer ..... D21/157 X
D. 148,906 3/1948 Blecher ..... D21/157 X
D. 187,248 2/1960 Sampson ..... D16/2 X
D. 192,170 2/1962 Kovac ..... D21/157
D. 209,604 12/1967 Wormser ..... D21/247

D. 215,498 9/1969 Ceccacci ..... D16/2
D. 234,047 1/1975 Murdock ..... D16/2 X
D. 275,571 9/1984 Carrington ..... D16/2
D. 278,269 4/1985 Thornalley ..... D21/247
D. 281,800 12/1985 Routzong ..... D21/157
2,509,785 5/1950 Rubin ..... D21/157 X

OTHER PUBLICATIONS

35mm Photography-10/85-p. 9-Cameras at bottom-right.

Primary Examiner-Nelson C. Holtje
Attorney, Agent, or Firm-Fitzpatrick, Cella, Harper & Scinto

CLAIM

[57] The ornamental design for a camera, as shown and described.

DESCRIPTION

FIG. 1 is a front elevational view of a camera showing my new design;
FIG. 2 is a rear elevation view thereof;
FIG. 3 is a top plan view thereof;
FIG. 4 is a bottom plan view thereof;
FIG. 5 is a left side elevational view thereof;
FIG. 6 is a right side elevational view thereof;
FIG. 7 is a top and left rear perspective view thereof.

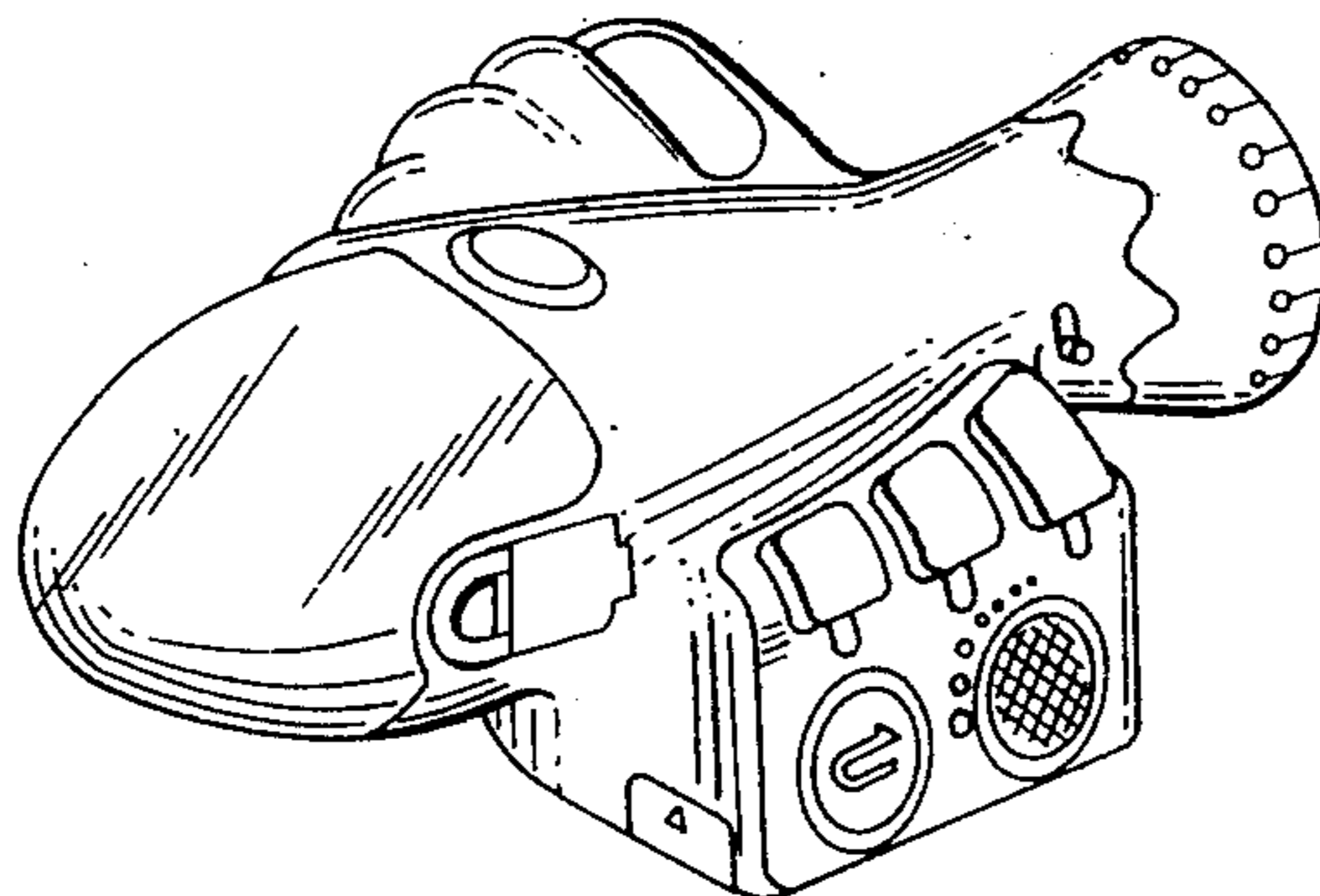

FIG. 1

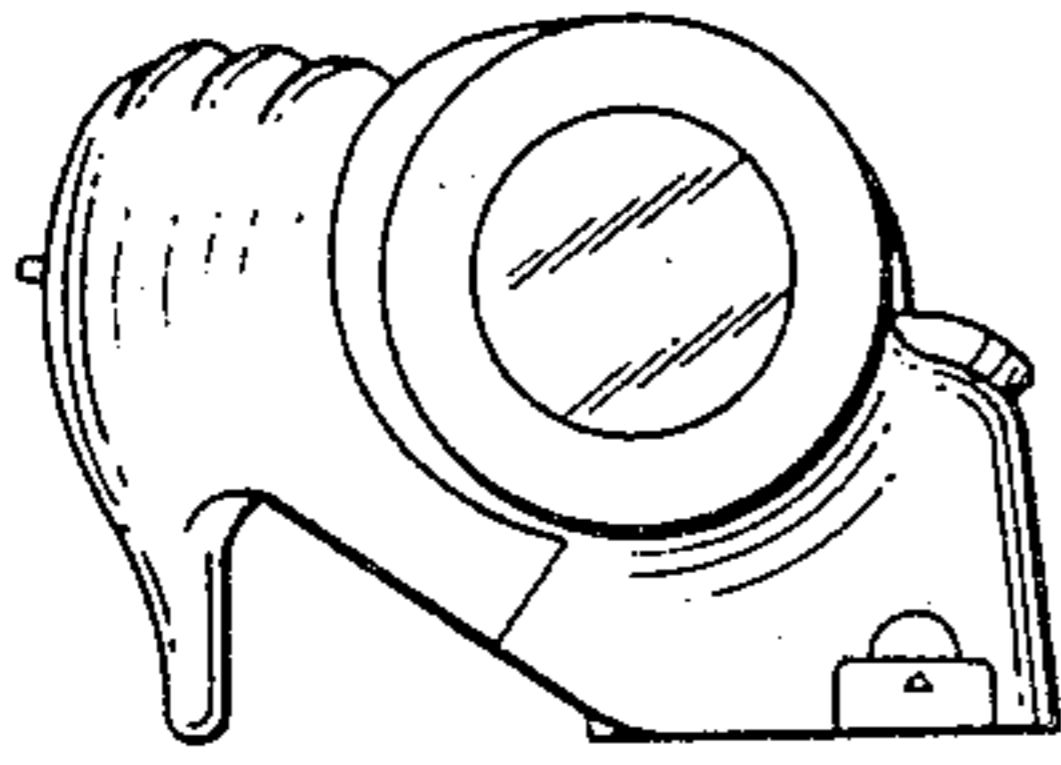

FIG. 2

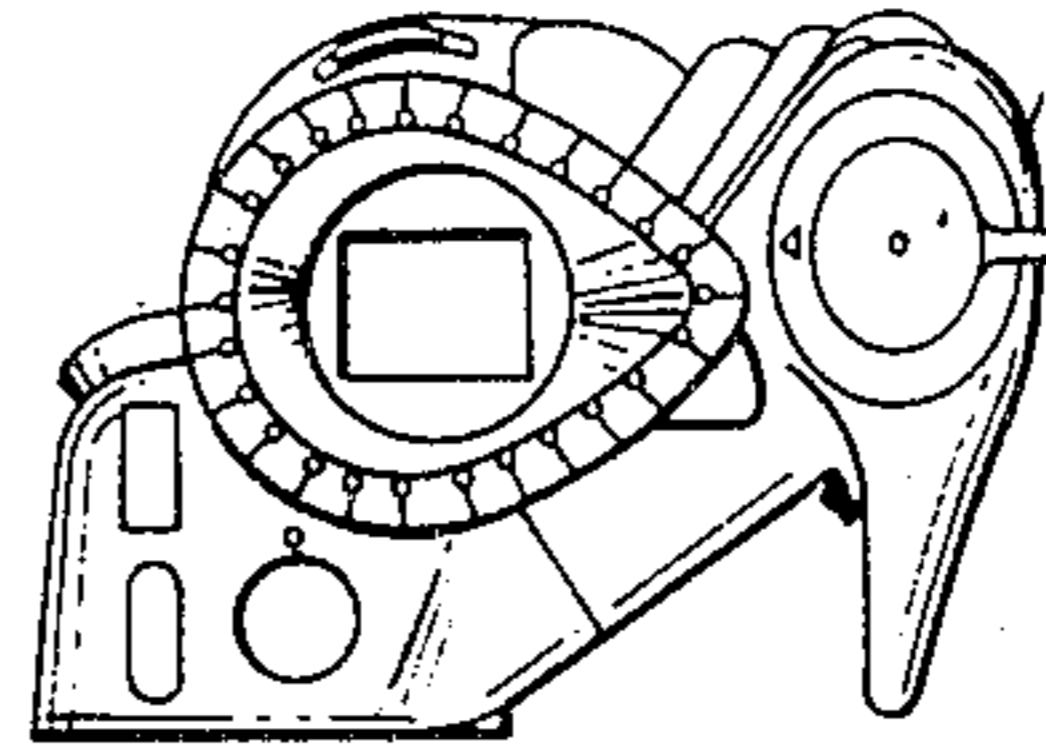

FIG. 3

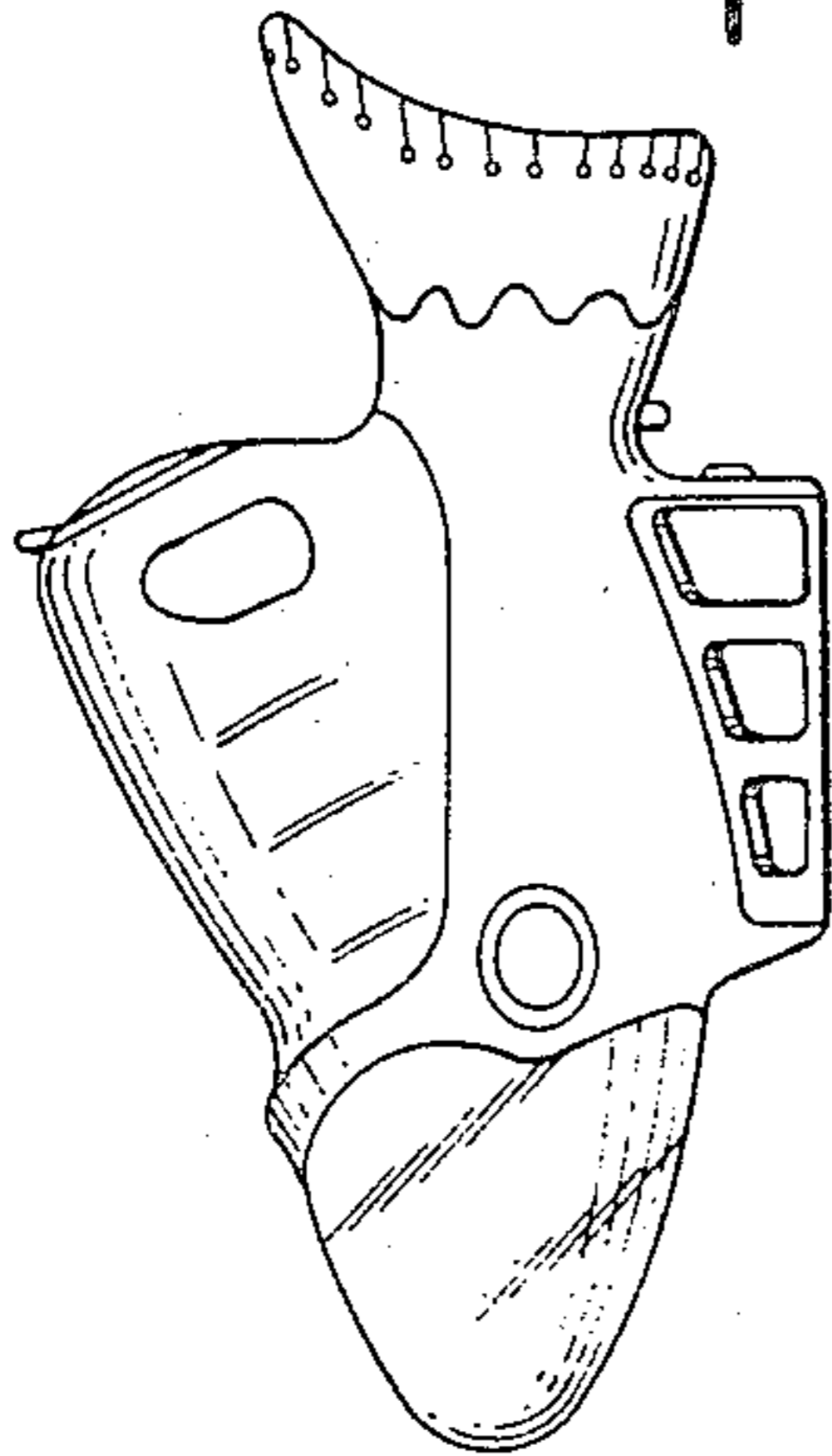

FIG. 4

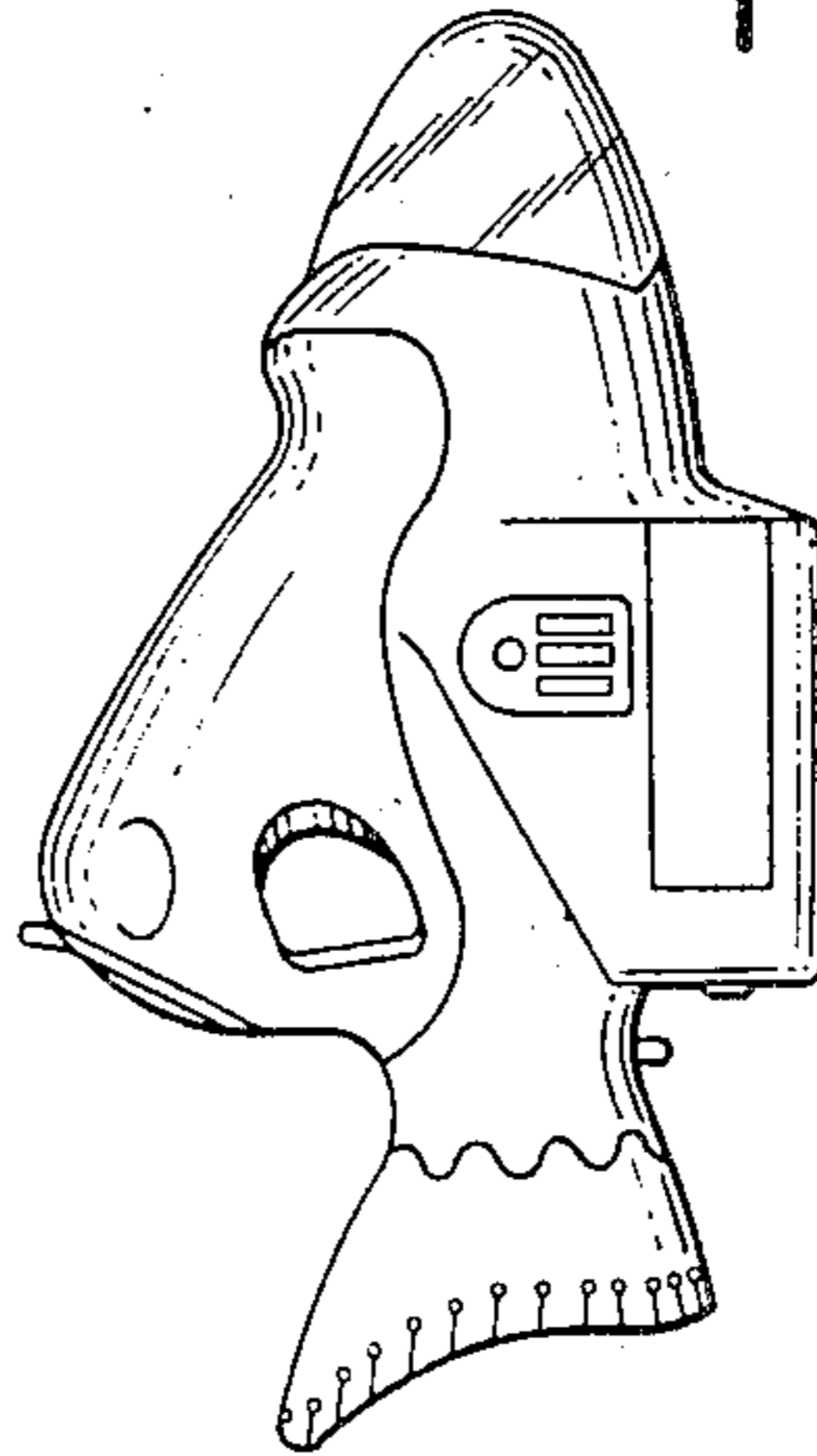

FIG. 5

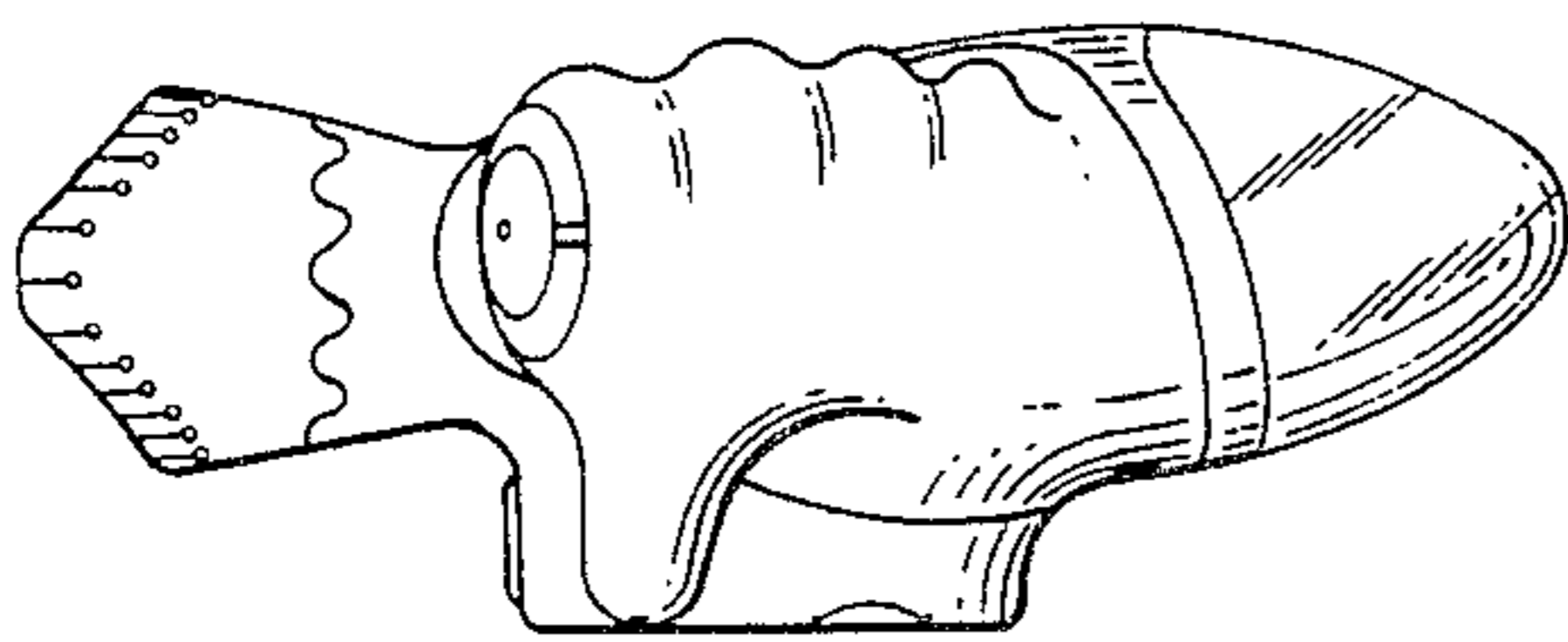

FIG. 6

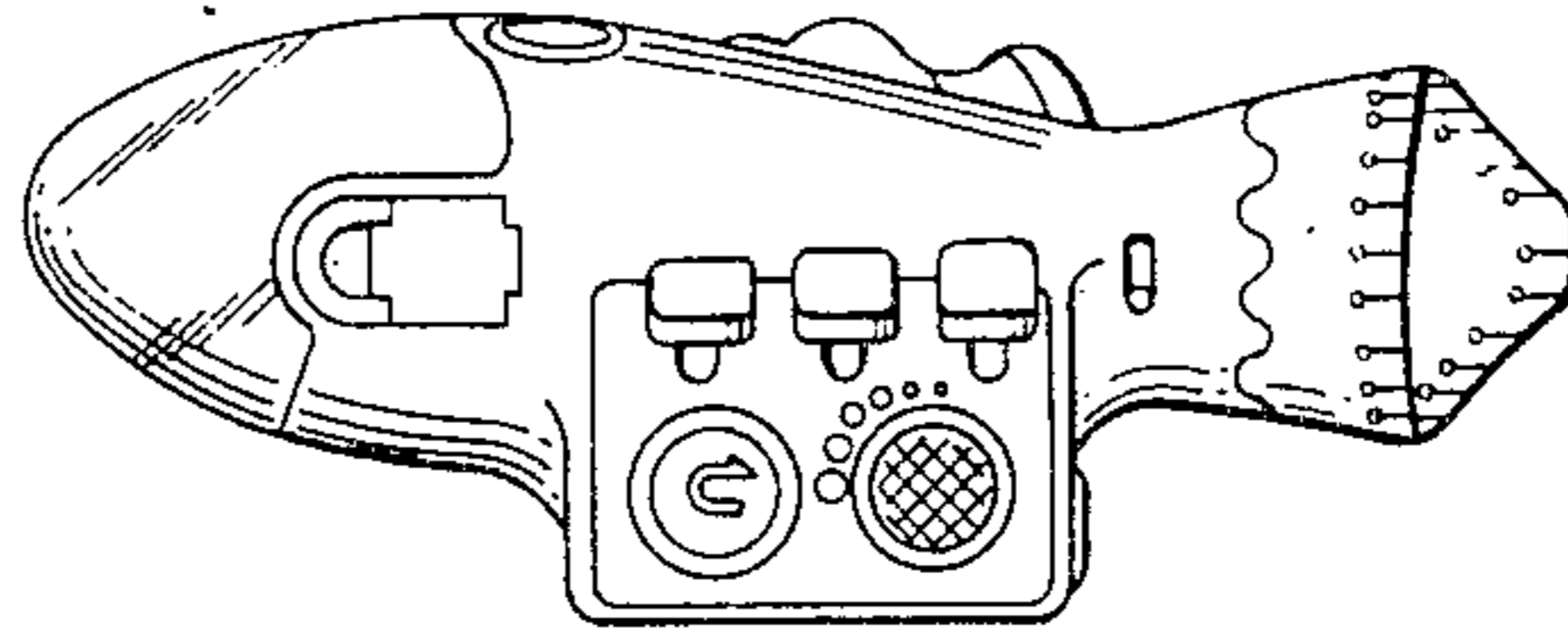

FIG. 7

