

[54] TELEPHONE

[75] Inventors: Kouji Anno; Masayuki Takahashi, both of Tokyo, Japan

[73] Assignee: Kazumi Shokai Company, Limited, Tokyo, Japan

[**] Term: 14 Years

[21] Appl. No.: 730,502

[22] Filed: May 6, 1985

[30] Foreign Application Priority Data

Nov. 10, 1984 [JP] Japan 59-46375

[52] U.S. Cl. D14/53; D14/62; D14/63

[58] Field of Search D14/53, 62, 63, 64; 179/179, 100 R, 100 D, 100 C, 101, 103; D21/111

[56] References Cited

U.S. PATENT DOCUMENTS

- D. 189,580 1/1961 Cannon D14/62
- D. 197,467 2/1964 Peterson D14/53
- D. 227,782 7/1973 Hozell et al. D14/53
- D. 245,843 9/1977 Hirasawa et al. D14/53 X
- D. 257,977 1/1981 Blomberg D14/62 X
- D. 262,879 2/1982 Marshall D14/53
- D. 263,589 3/1982 Read D14/53 X
- D. 264,211 5/1982 Heliner D14/62
- D. 270,157 8/1983 Boldt et al. D14/63

4,220,828 9/1980 Ruzic 179/100 D
4,463,222 7/1984 Poradowski 179/179 X

OTHER PUBLICATIONS

B. A. Pargh 1983 catalog ©: at p. 9; "Rendez-Vous Tone": Order No. 202020 by Northern Telcom. Telephony, Apr. 14, 1980: ad by GNT Automatic A/S: Danish Design Phone Set. Telephony, Apr. 7, 1982: Telart "PUPON" Phone at p. 14.

Primary Examiner—Wallace R. Burke
Assistant Examiner—Horace B. Fay
Attorney, Agent, or Firm—McAulay, Fields, Fisher, Goldstein & Nissen

[57] CLAIM

The ornamental design for a telephone, as shown and described.

DESCRIPTION

FIG. 1 is a partial left side, partial front and top perspective view of a telephone showing our new design; FIG. 2 is a perspective view with the handset partially inverted and spaced apart from the stand; FIG. 3 is a front elevational view thereof; FIG. 4 is a rear elevational view thereof; FIG. 5 is a top plan view thereof; FIG. 6 is a bottom plan view thereof; FIG. 7 is a left side elevational view thereof; and FIG. 8 is a right side elevational view thereof.

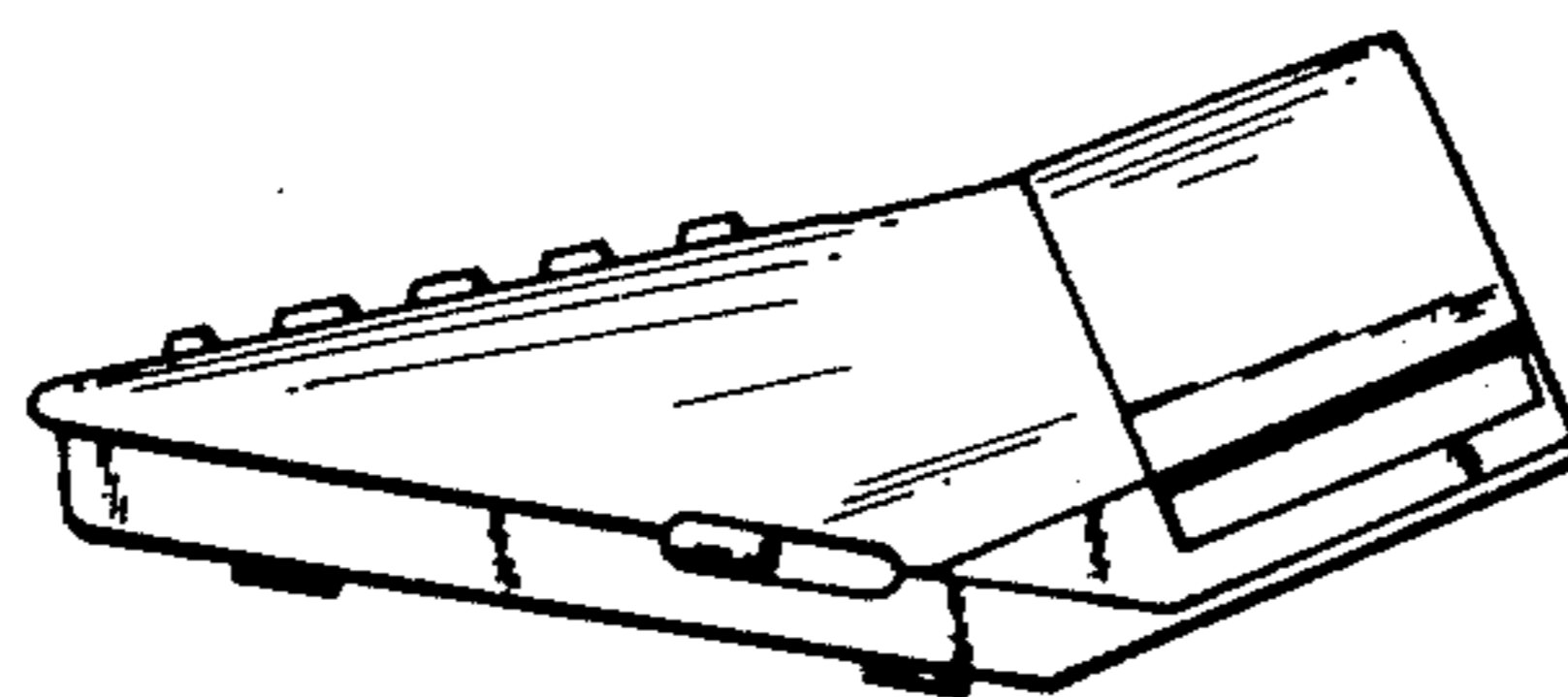
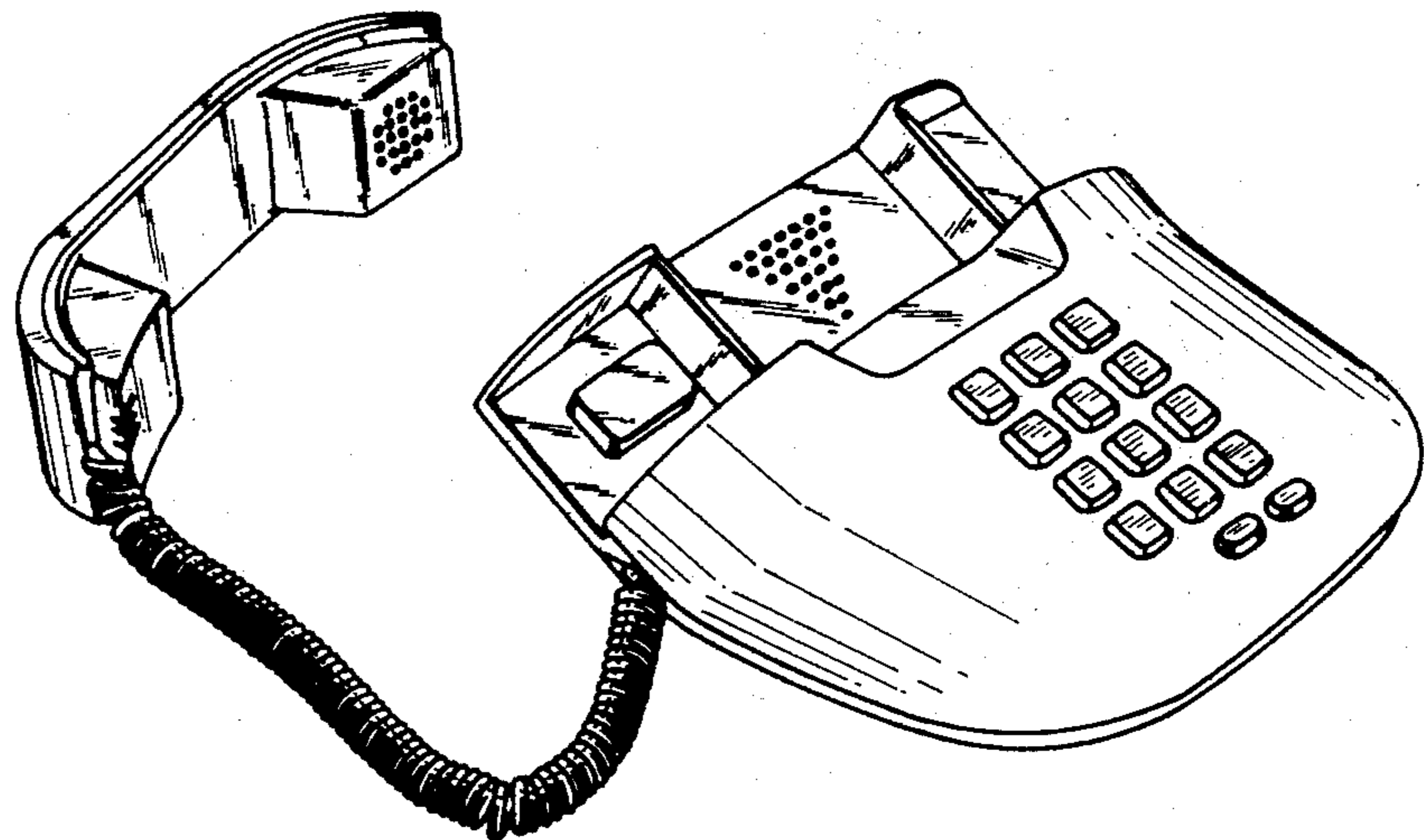

FIG. 1



FIG. 2

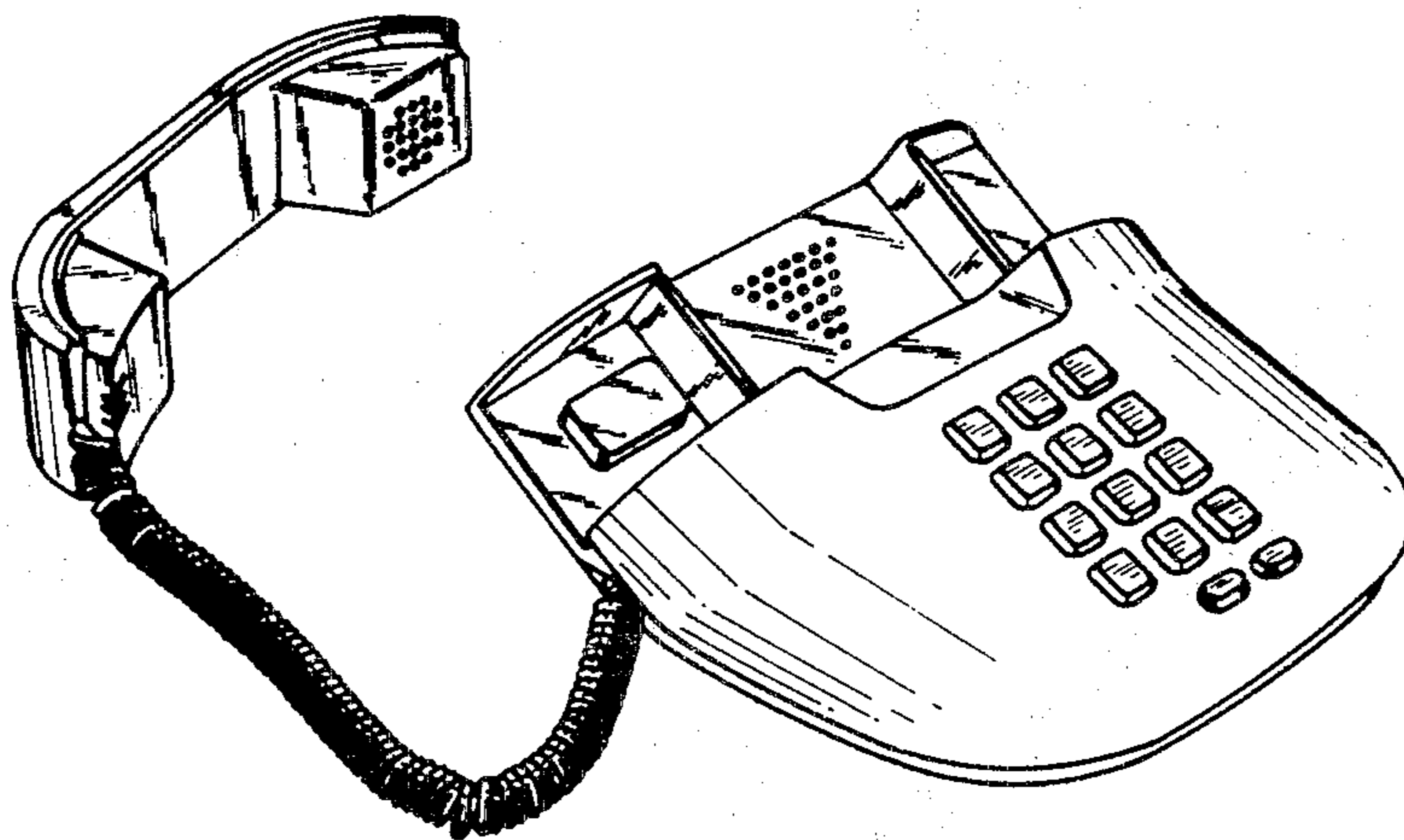

FIG. 3

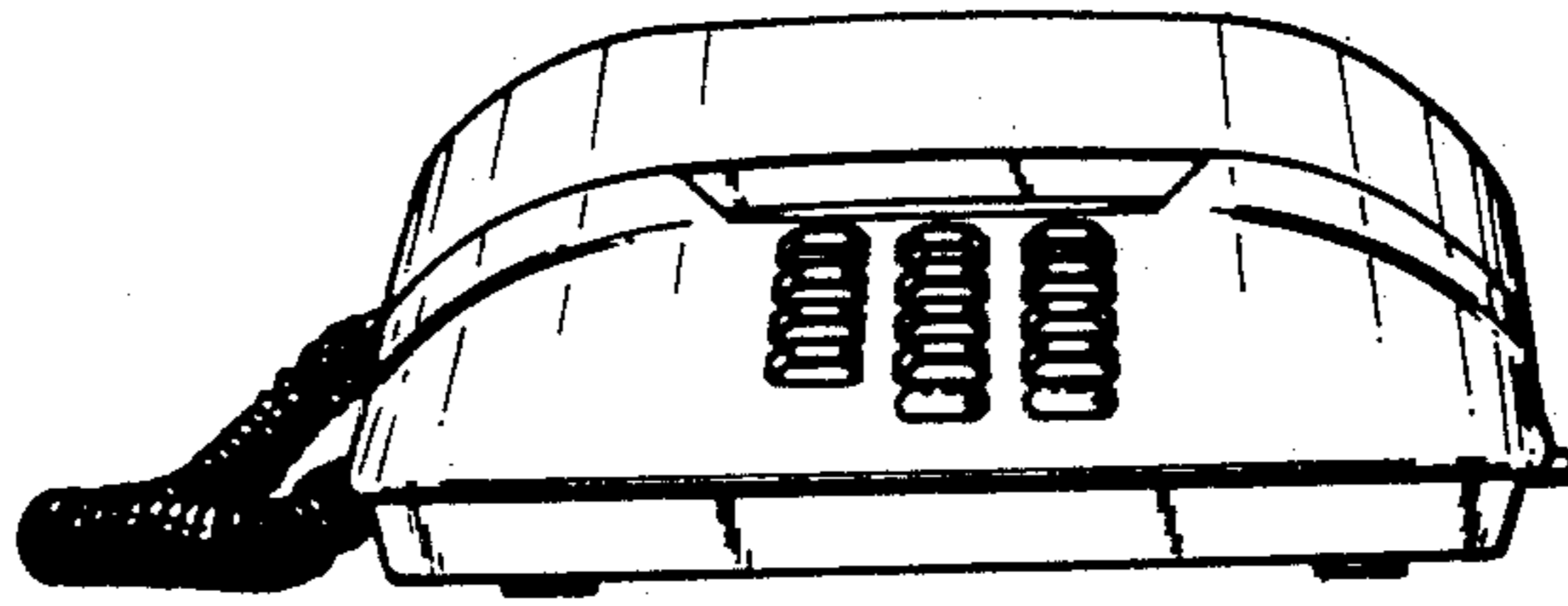

FIG. 4

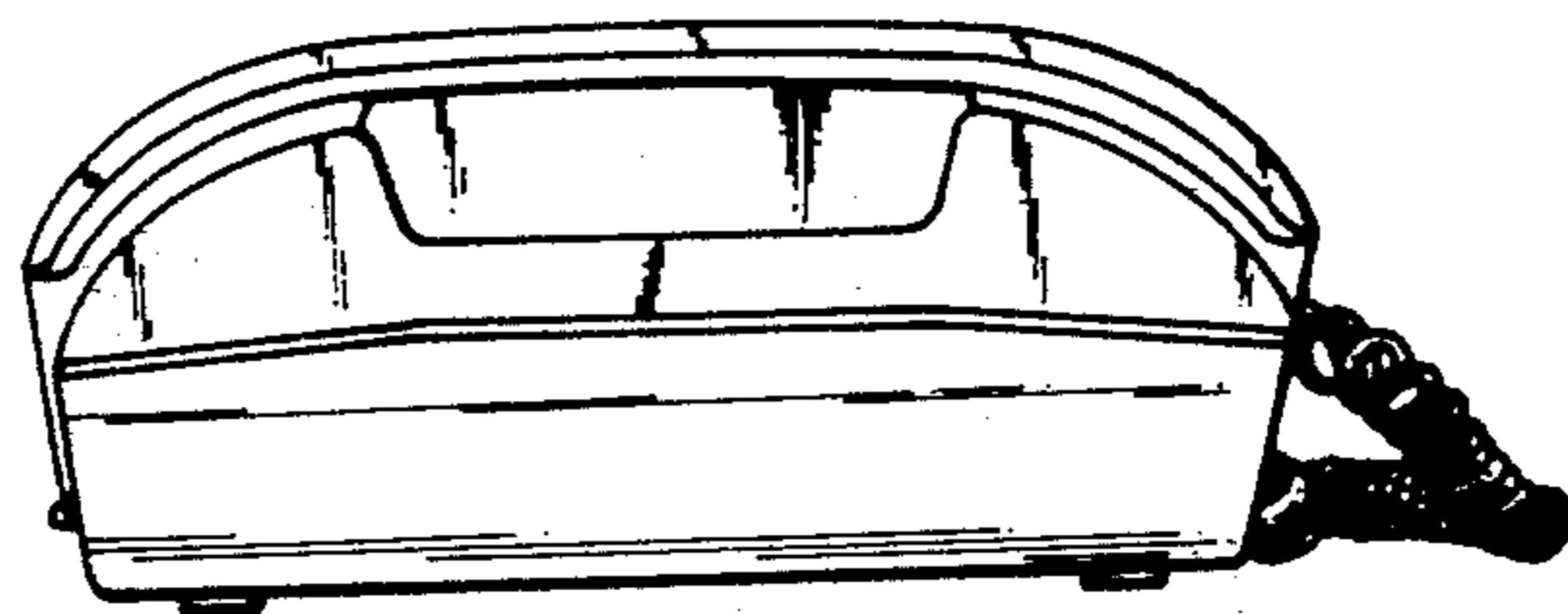

FIG. 5

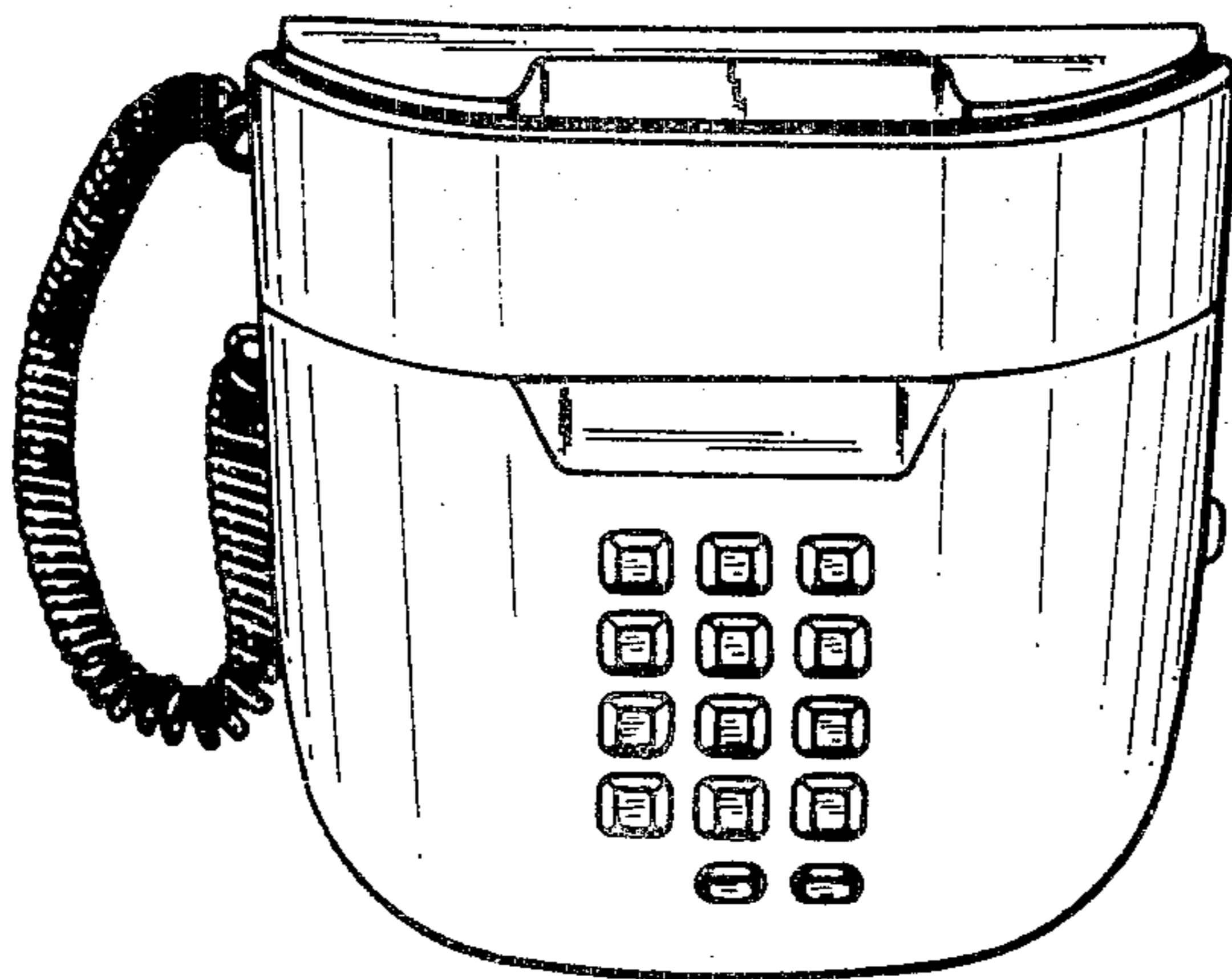

FIG. 6

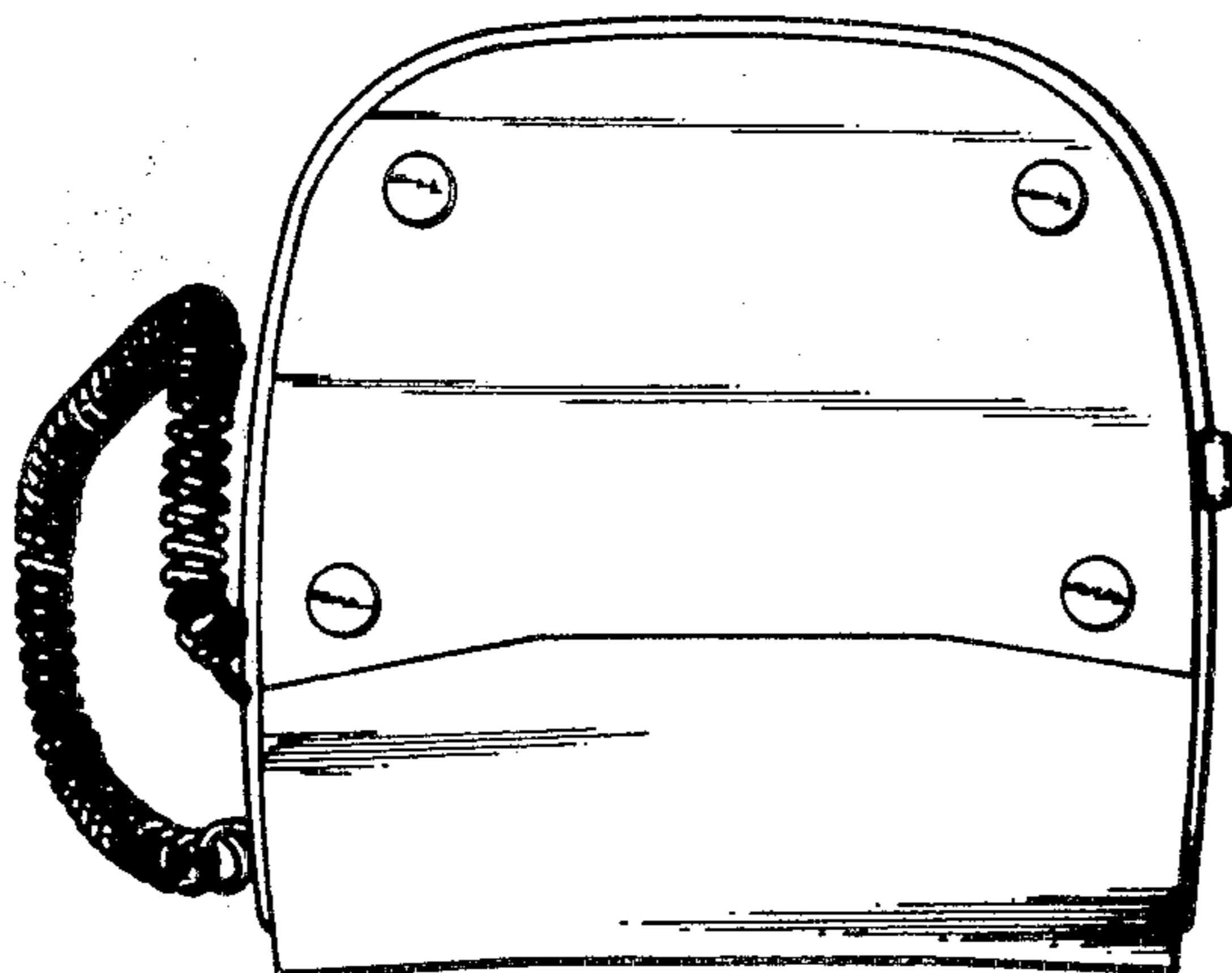

FIG. 7

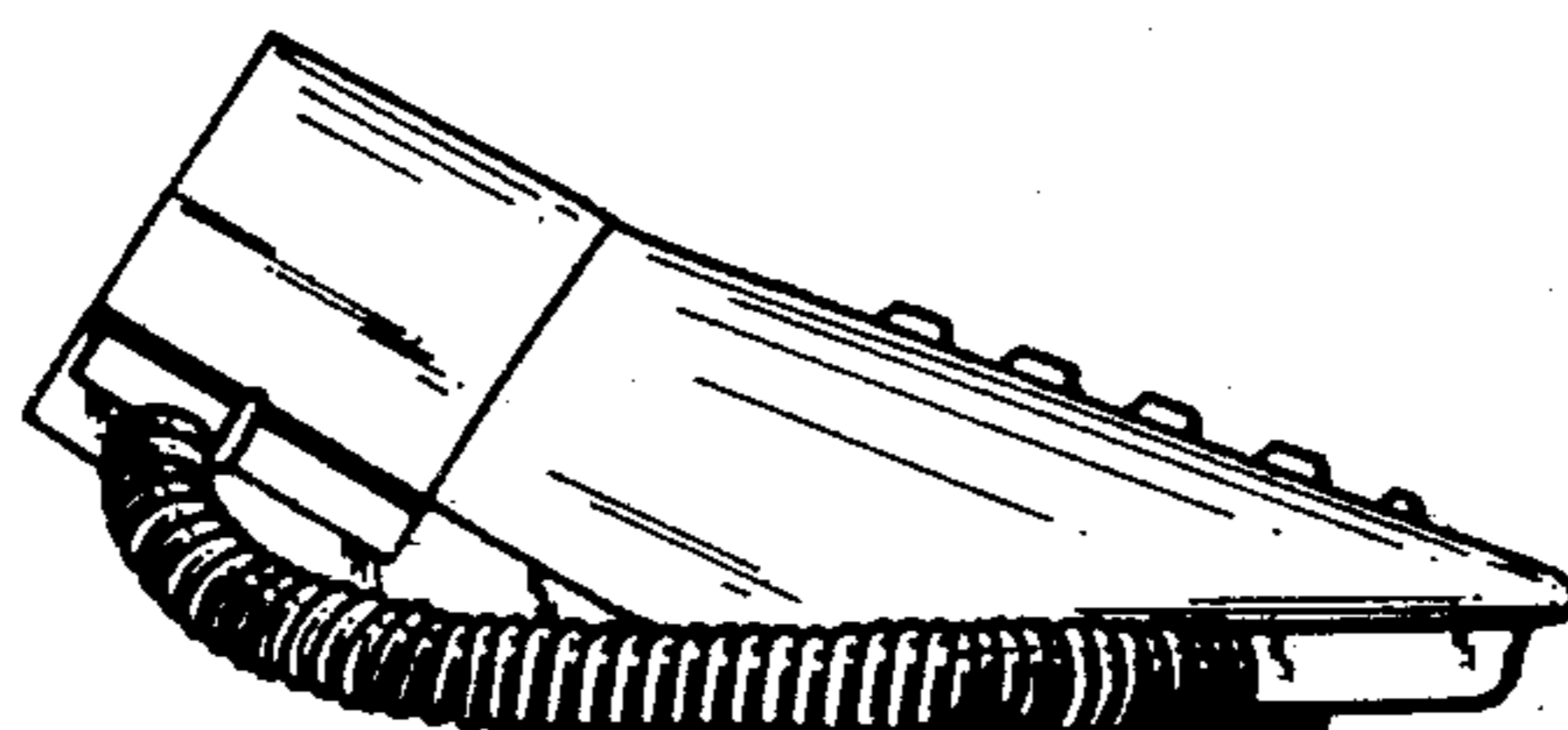

FIG. 8

