

[54] PLUMBING FITTING HANDLE

[75] Inventor: William R. Davis, Kiel, Wis.

[73] Assignee: Kohler Co., Kohler, Wis.

[**] Term: 14 Years

[21] Appl. No.: 687,965

[22] Filed: Dec. 31, 1984

[52] U.S. Cl. D23/29

[58] Field of Search D23/23-32;
D8/307, 308, 310-312; 16/121

[56] References Cited

U.S. PATENT DOCUMENTS

D. 84,462	6/1931	Clemmons	D23/29
D. 84,508	6/1931	Bloch	D23/29
D. 108,067	1/1938	Clemmons	D23/29
D. 147,404	9/1947	Fitter	D23/24
D. 149,386	4/1948	Smolonsky	D23/26
D. 189,081	10/1960	Hauser	D23/25
D. 189,179	11/1960	Manville	D23/25
D. 203,649	2/1966	Sundberg et al.	D23/26
D. 275,986	10/1984	Stairs, Jr.	D23/29

OTHER PUBLICATIONS

Domestic Engineering, May 1960, p. 132, bottom left item.

Gerber Plumbing Fixtures Catalog, p. 23, undated, admitted prior art, showing a "Wrist/Surgical" Handle. Kohler Co. "K-300 Plumbing Products Catalog", pp. 138 and H-35, Apr. 1982, showing K-7761-TW and K-13671 handles; p. 121, Bravura Series K-6846 Faucet.

Primary Examiner—James R. Largen
Attorney, Agent, or Firm—Quarles & Brady

[57] CLAIM

The ornamental design for a plumbing fitting handle, as shown and described.

DESCRIPTION

FIG. 1 is a top perspective view of a plumbing fitting handle showing my new design; FIG. 2 is a rear elevational view thereof, the front being a mirror image of the rear shown; FIG. 3 is a top plan view thereof; FIG. 4 is a right side elevational view thereof; FIG. 5 is a left side elevational view thereof; and FIG. 6 is a rear elevational view of a modified form of the plumbing fitting handle shown in FIG. 1, the front being a mirror image of the rear shown.

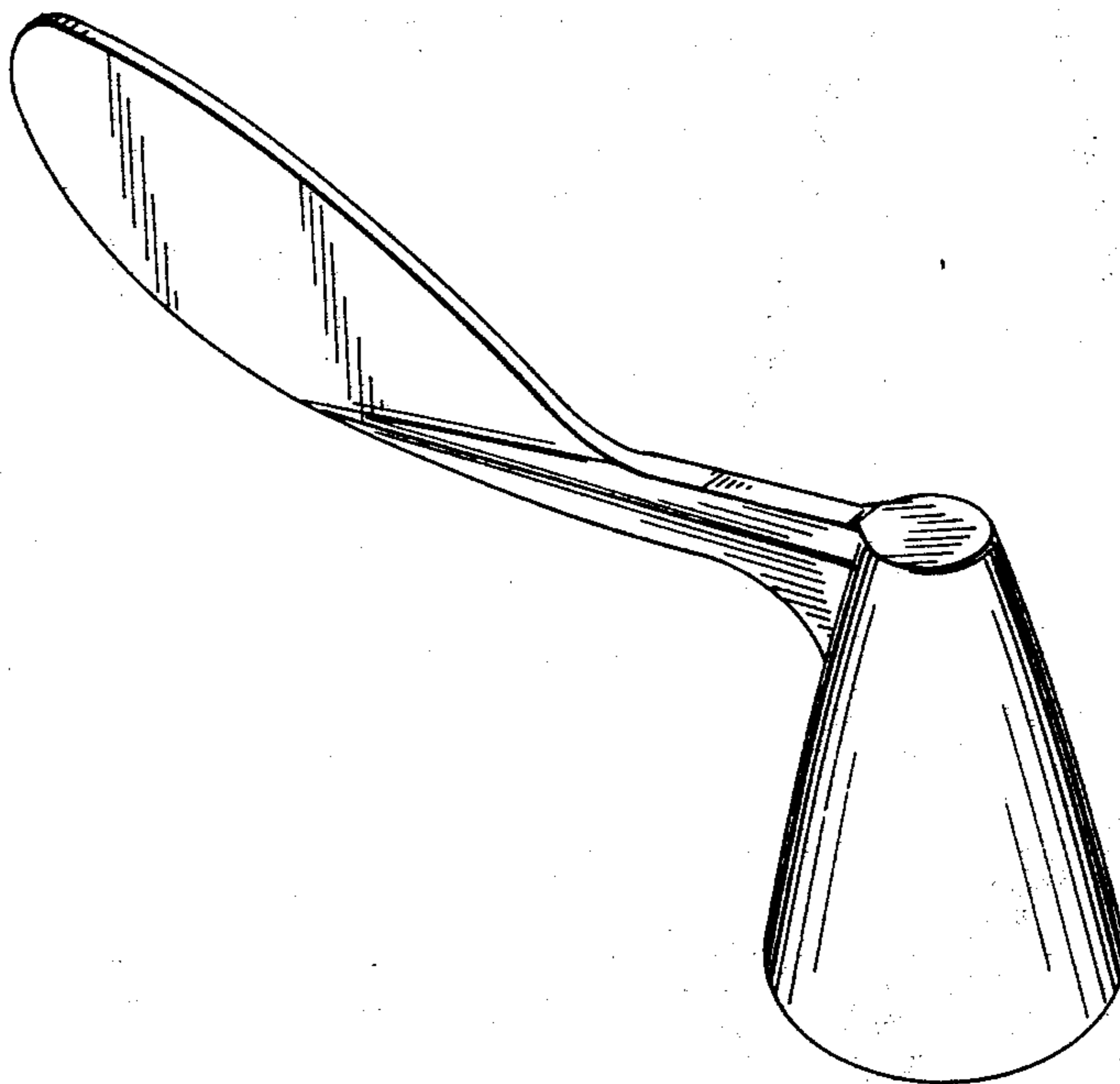

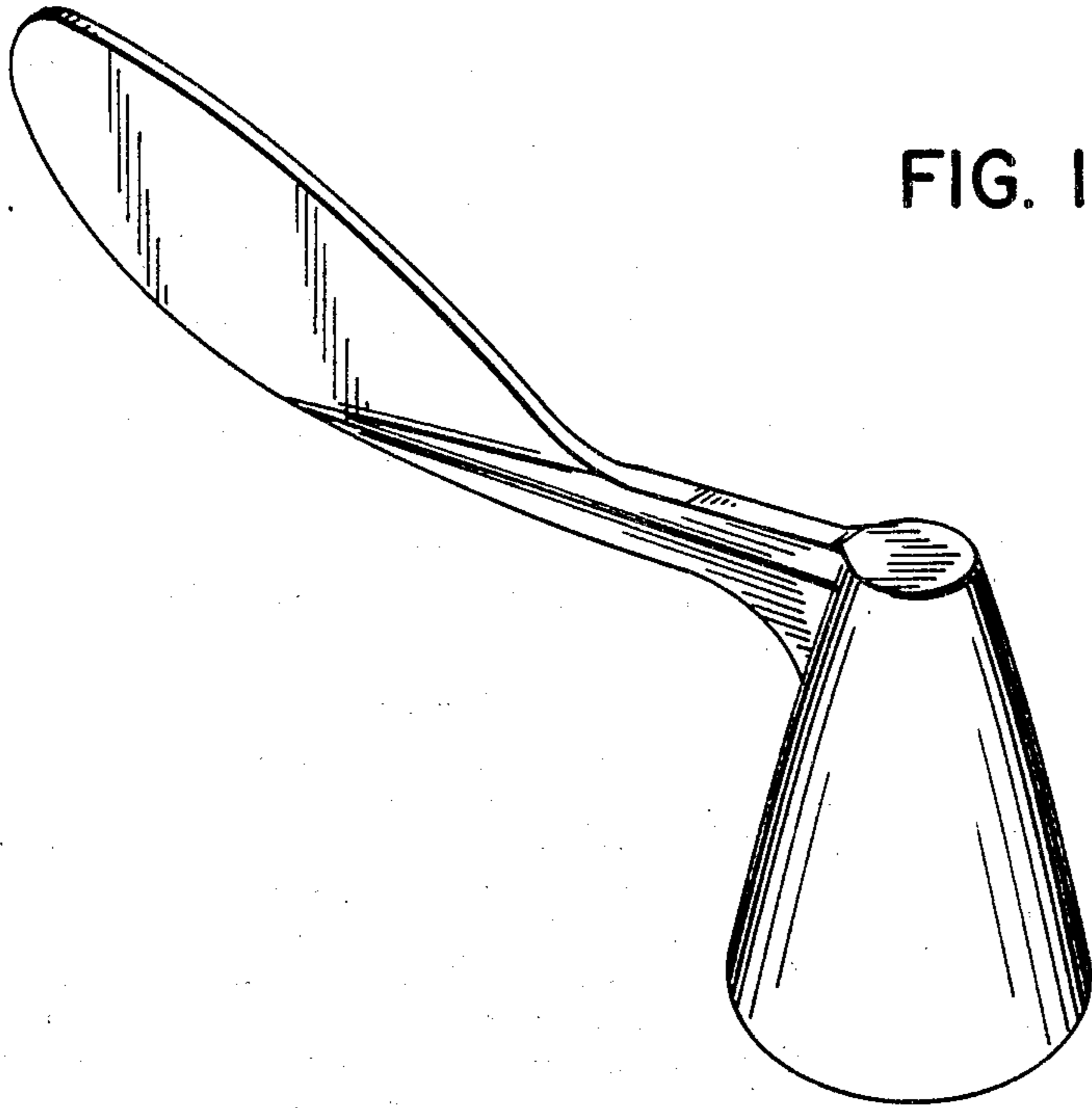

FIG. 1

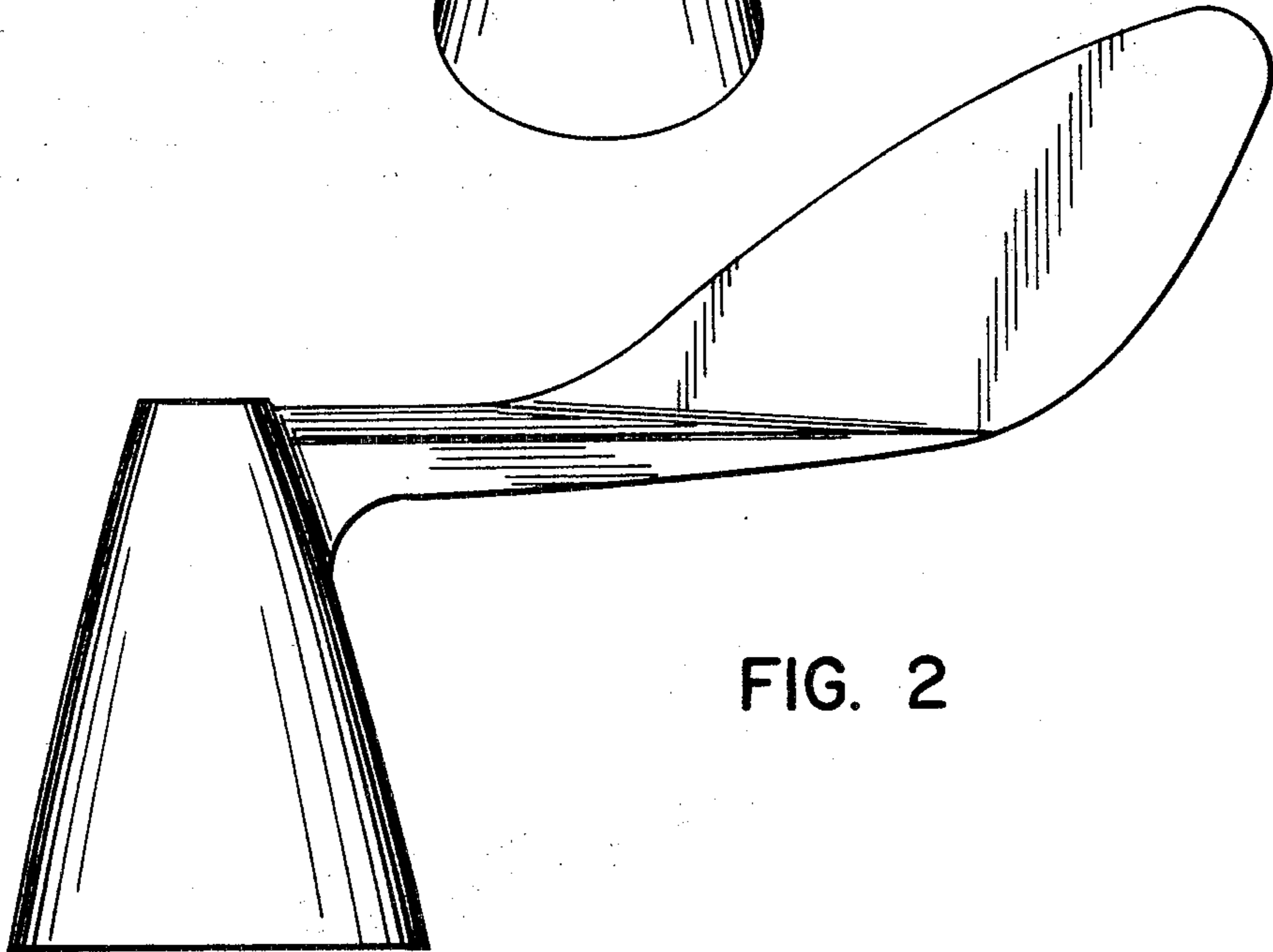

FIG. 2

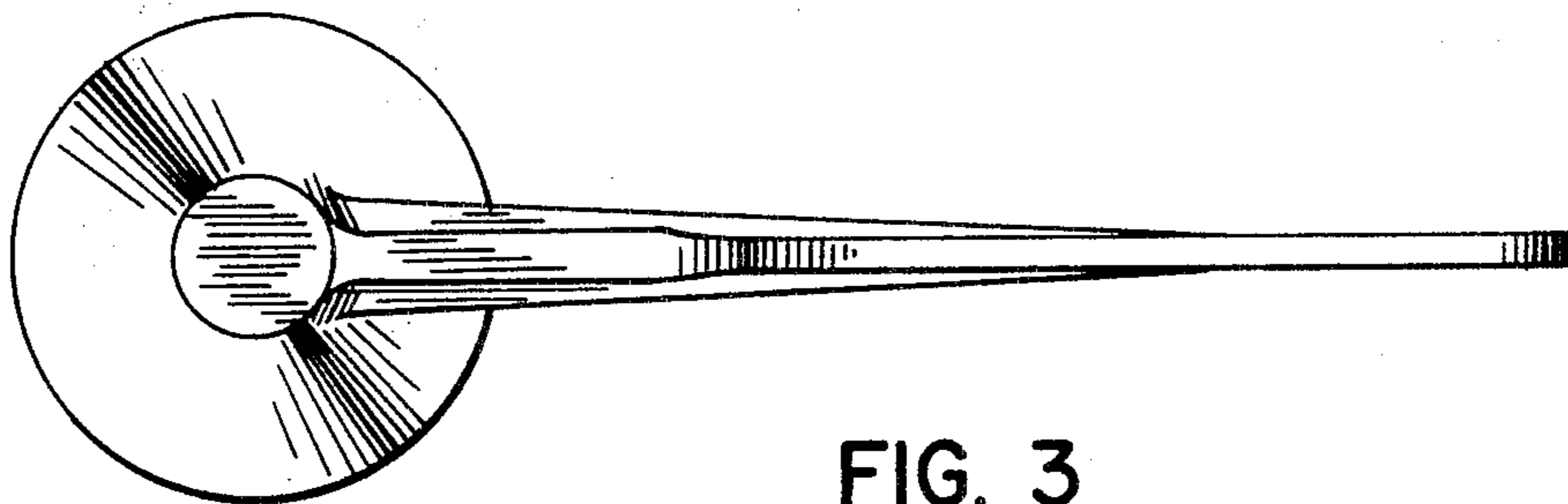

FIG. 3

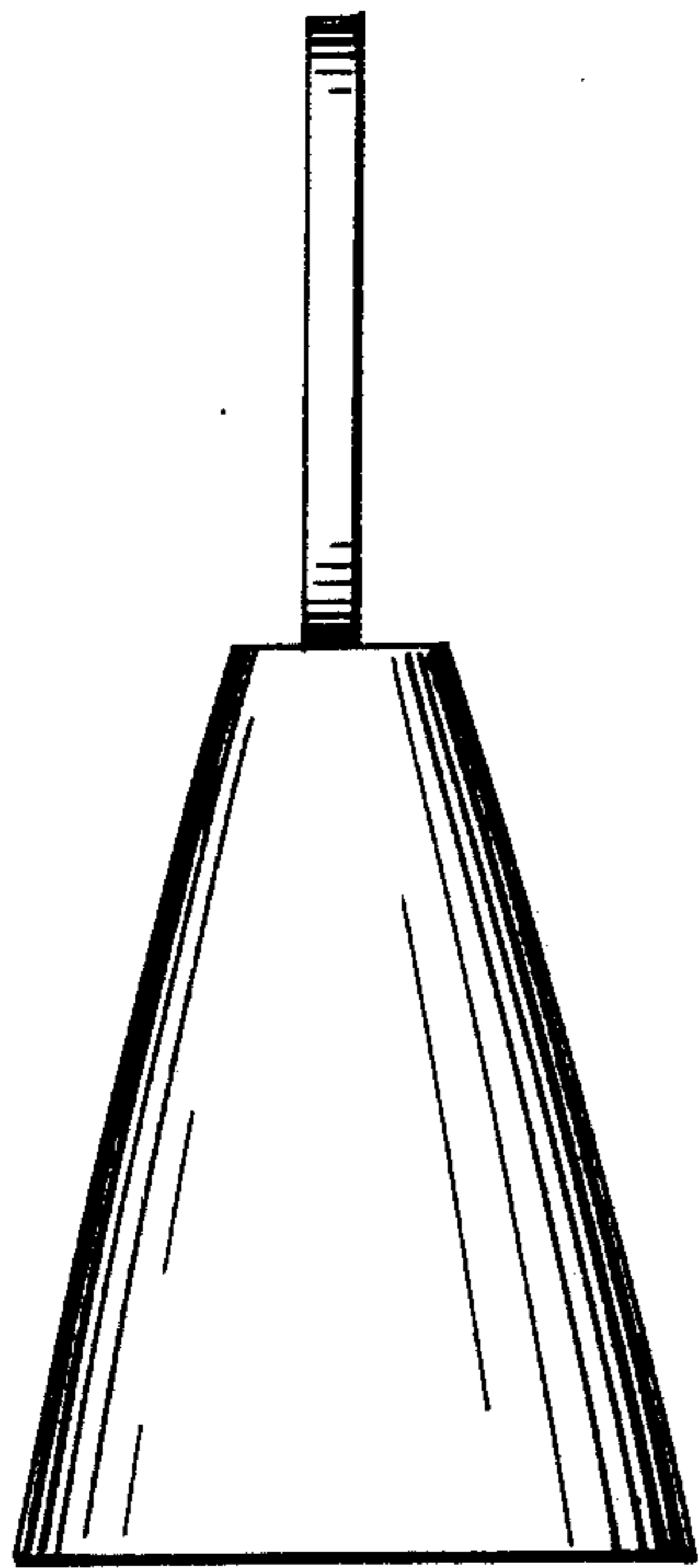

FIG. 4

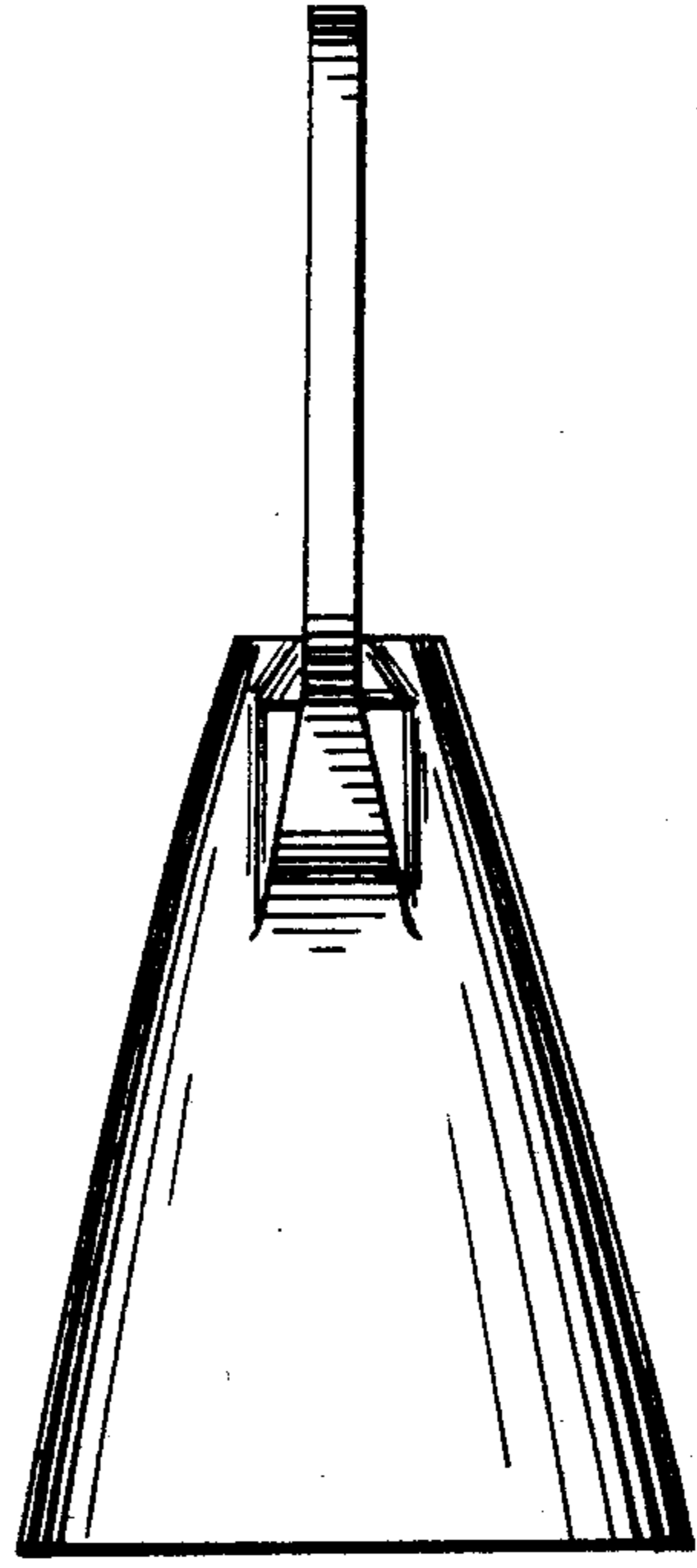

FIG. 5

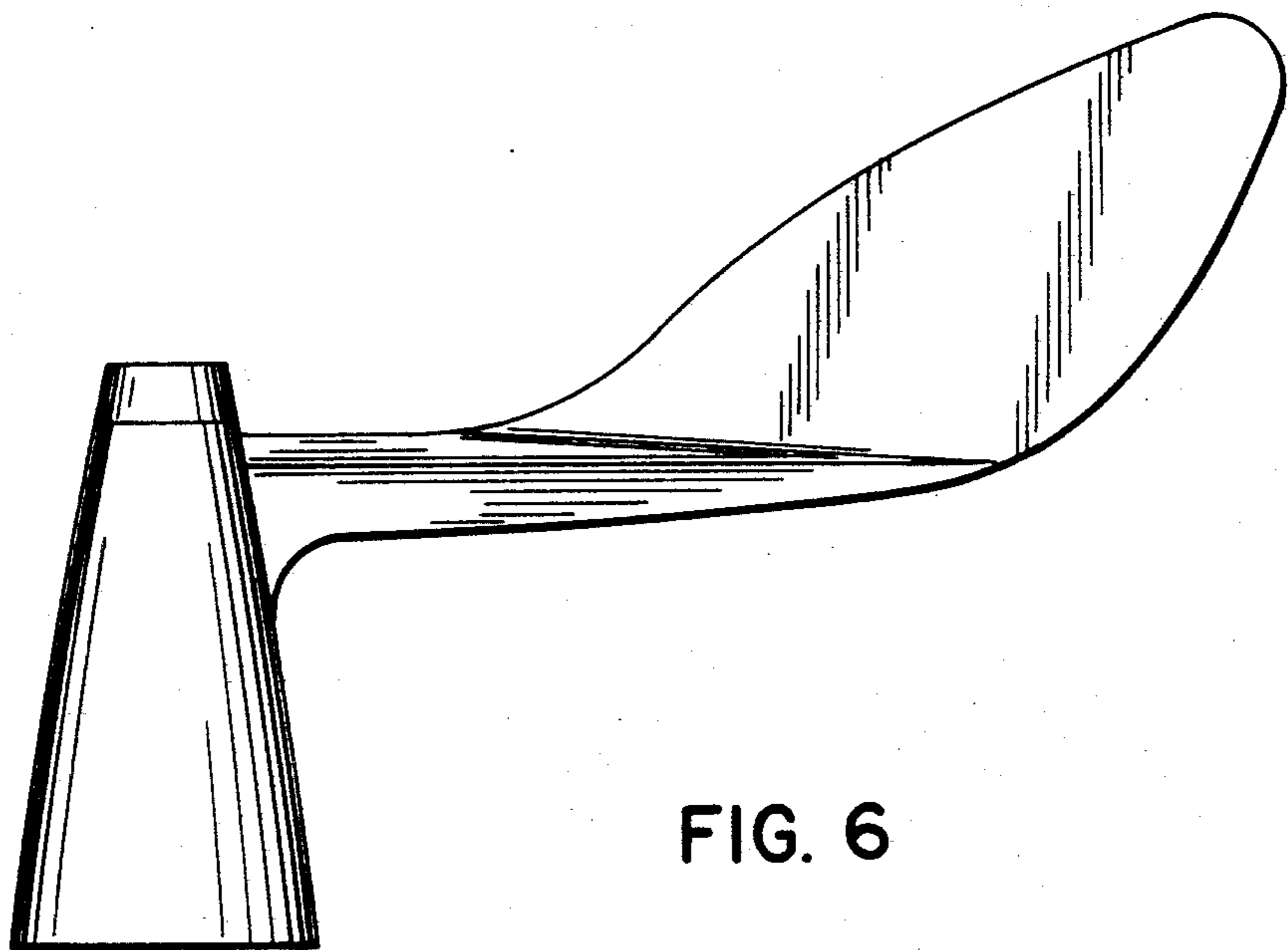

FIG. 6