

[54] TOY FIRE TRUCK

D. 277,690 2/1985 Wilkes D21/135

[75] Inventor: Kenneth R. Wilkes, East Aurora, N.Y.

[73] Assignee: The Quaker Oats Company, Chicago, Ill.

[**] Term: 14 Years

[21] Appl. No.: 693,757

[22] Filed: Jan. 23, 1985

[52] U.S. Cl. D21/133

[58] Field of Search D21/128, 133, 134, 135, D21/139, 140; D12/13, 12; 446/465, 466, 432

[56] References Cited

U.S. PATENT DOCUMENTS

D. 166,003	2/1952	Sly et al.	D21/133
D. 201,841	8/1965	Douglas	D21/133
D. 205,529	8/1966	Palmer	D21/133
D. 277,688	2/1985	Wilkes	D21/133

OTHER PUBLICATIONS

FAO Schwarz Catalog, 1983-1984 Fall-Winter, p. 13, Item "R" Toy Fire Engine.

Primary Examiner—Charles A. Rademaker
Attorney, Agent, or Firm—Cumpston & Shaw

[57] CLAIM

The ornamental design for a toy fire truck, substantially as shown and described.

DESCRIPTION

FIG. 1 is a left-side elevational view of a toy fire truck showing my new design;

FIG. 2 is a top plan view thereof with a hose section omitted for clarity;

FIG. 3 is a front elevational view thereof;

FIG. 4 is a rear elevational view thereof with a hose section omitted for clarity;

FIG. 5 is a bottom plan view thereof; and

FIG. 6 is a right-side elevational view thereof.

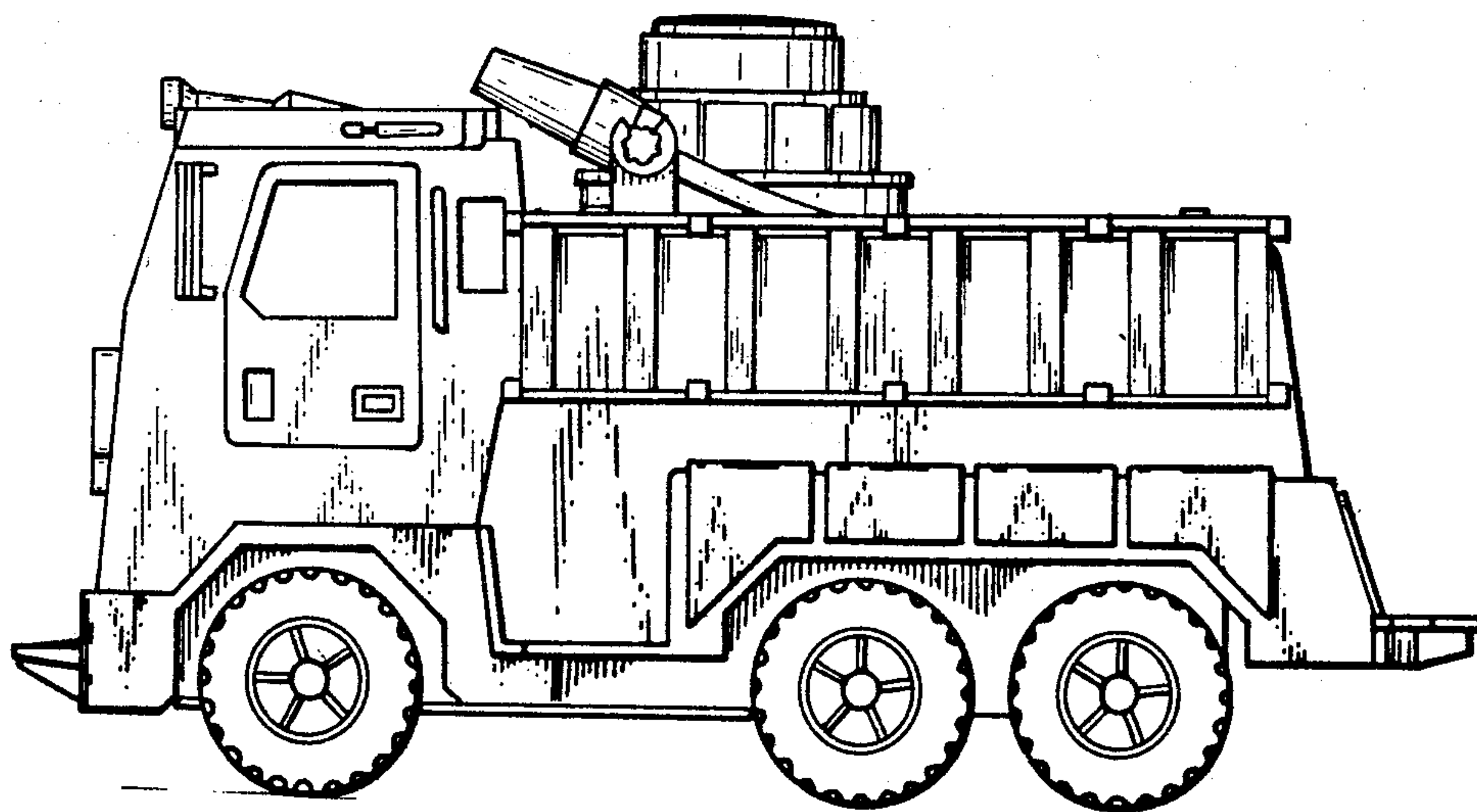

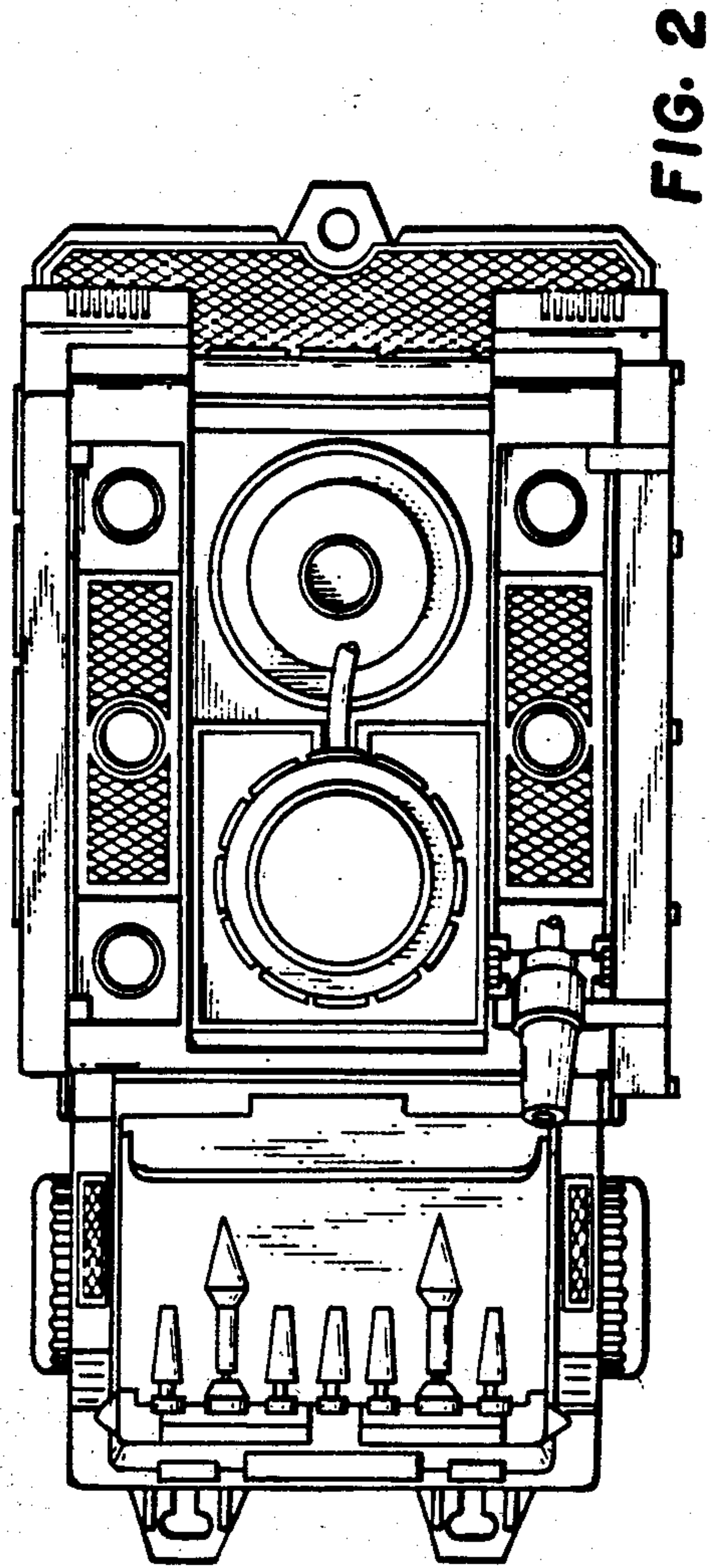
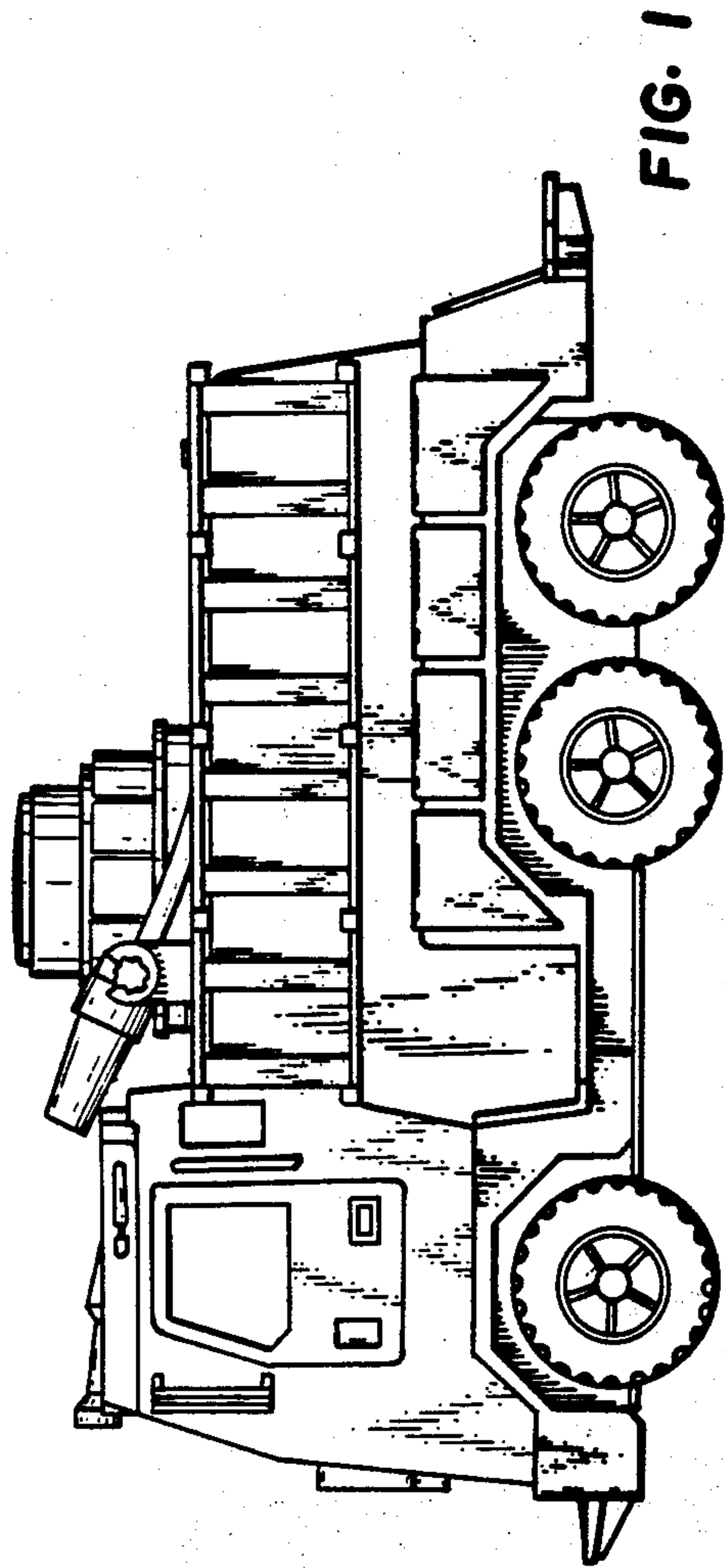

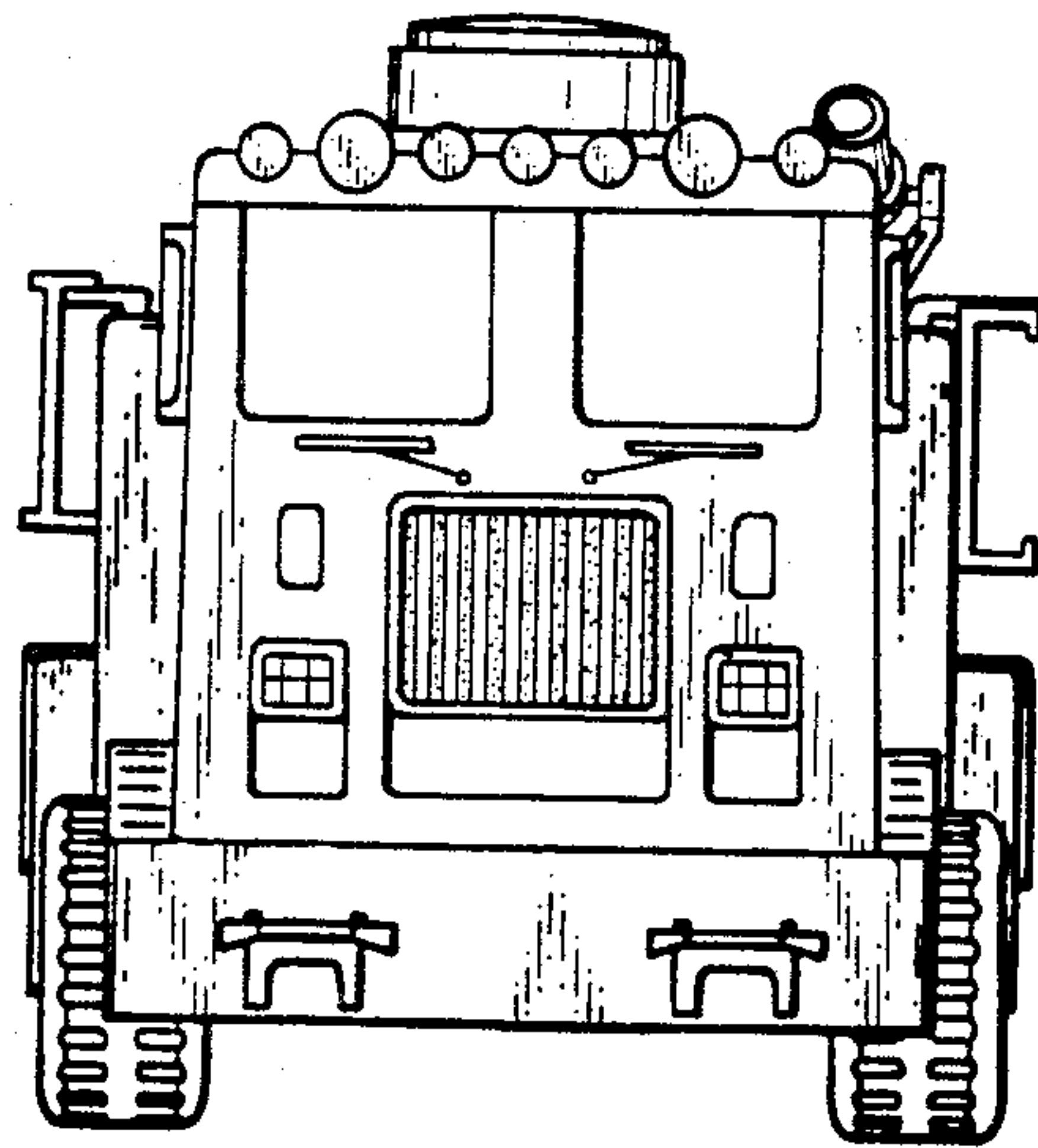

FIG. 3

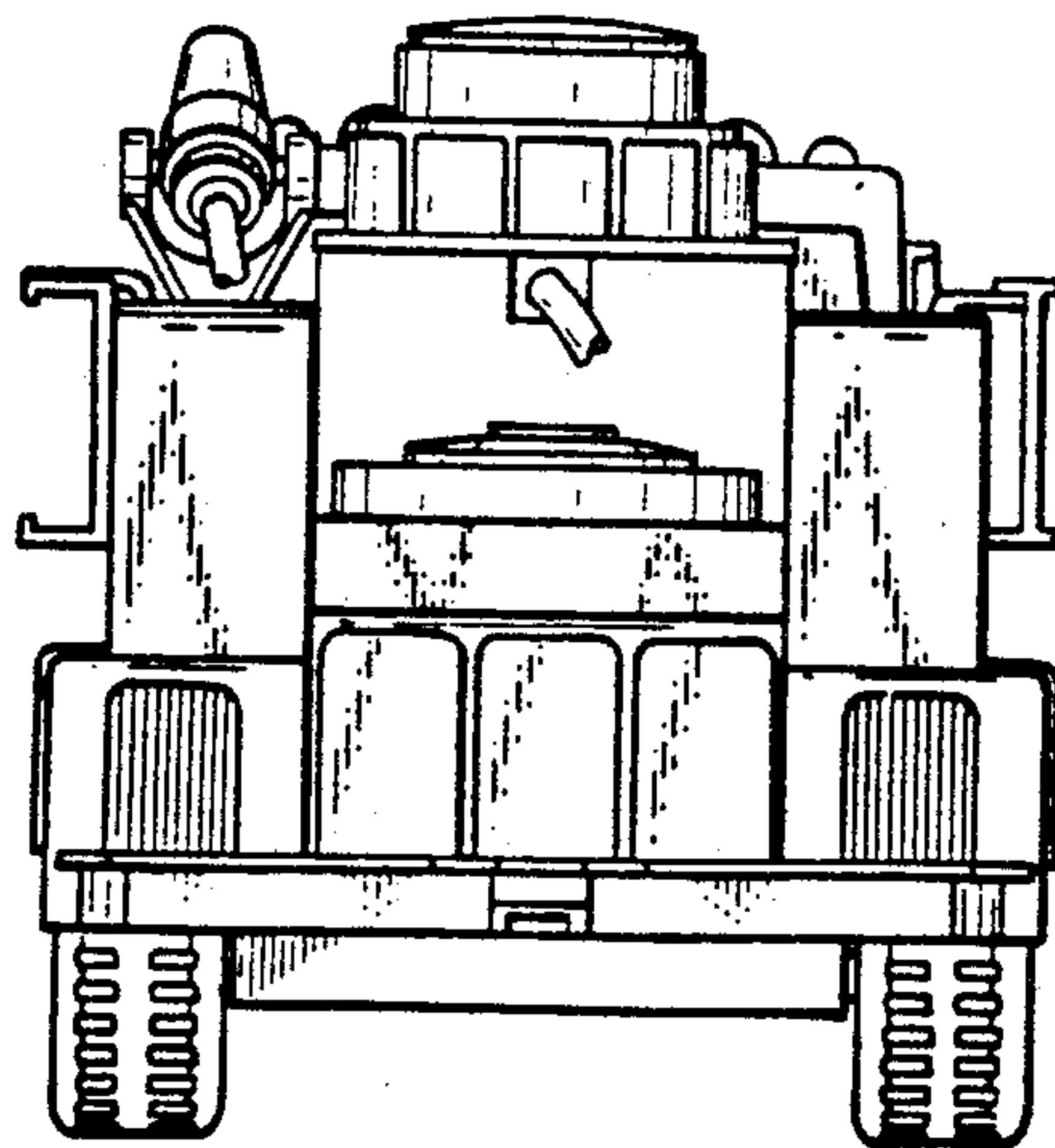

FIG. 4

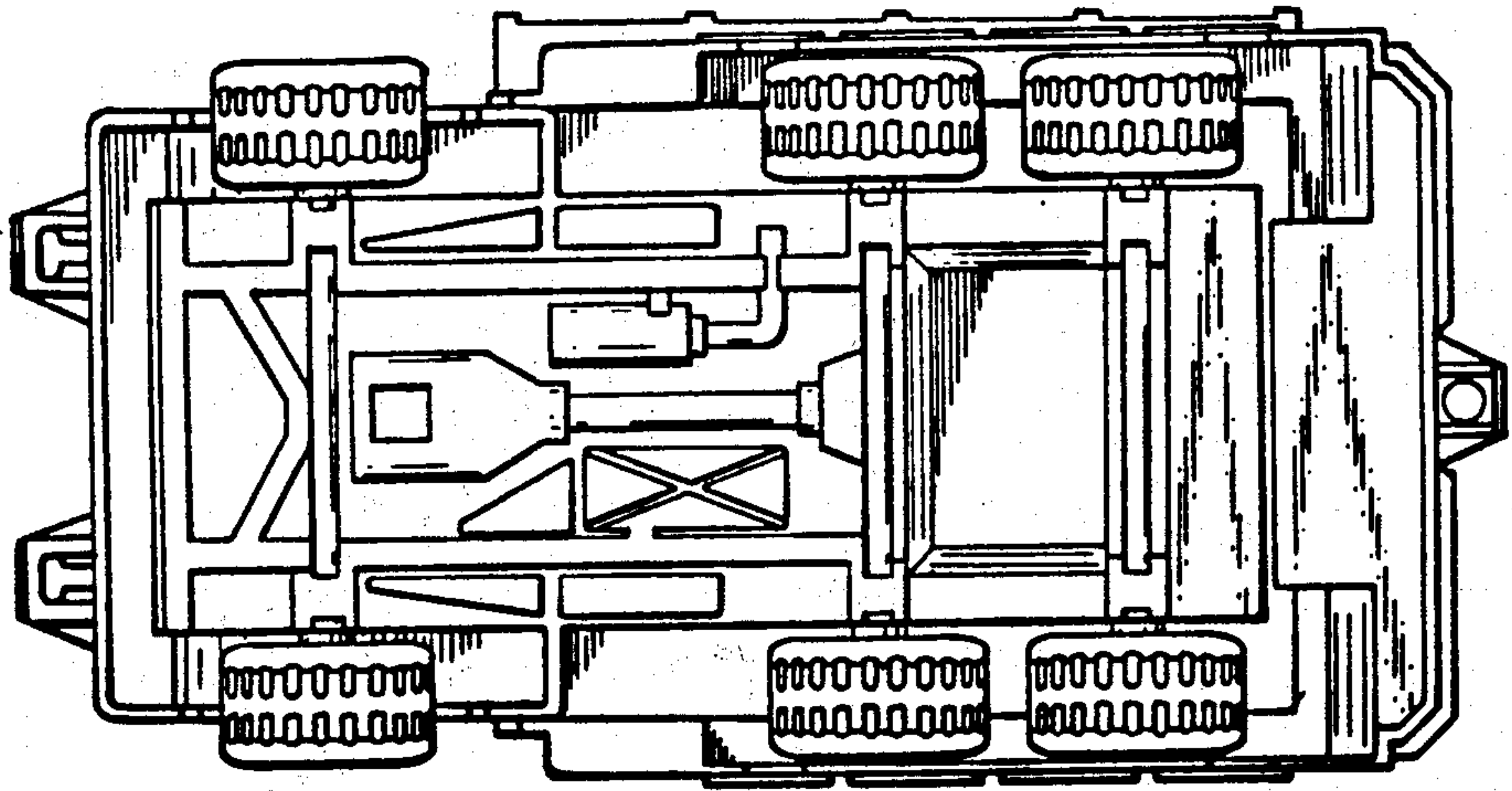

FIG. 5

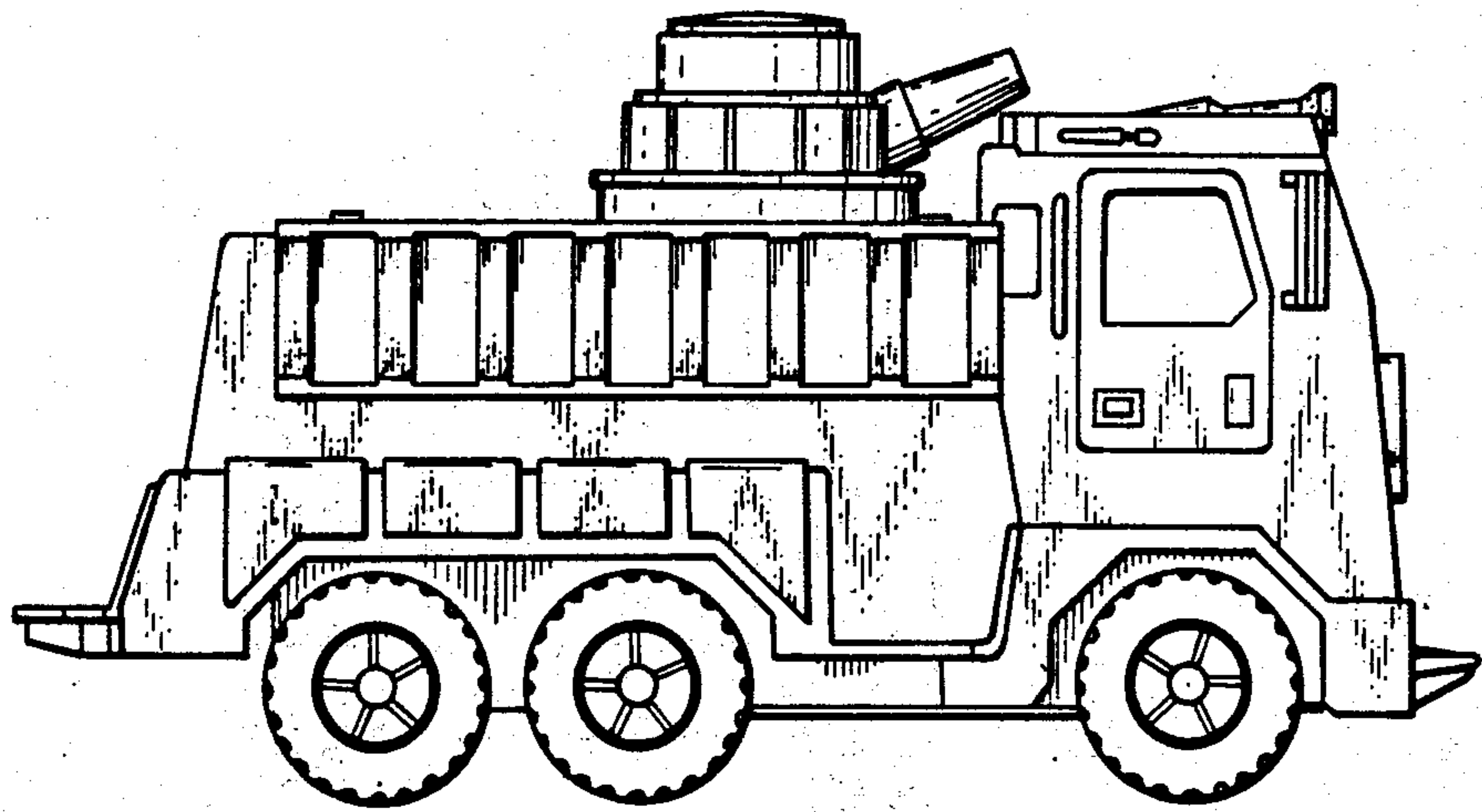

FIG. 6