

[54] DISPLAY TABLE OR SIMILAR ARTICLE

[76] Inventor: Joan H. Stauff, 202 Hillside Ct., Janesville, Wis. 53545

[**] Term: 14 Years

[21] Appl. No.: 634,221

[22] Filed: Jul. 25, 1984

[52] U.S. Cl. D6/467; D6/484

[58] Field of Search D6/449, 457, 467, 480, D6/484, 486, 487; D7/38; D9/347

[56] References Cited

U.S. PATENT DOCUMENTS

- D. 28,728 5/1898 Tanner D9/347
- D. 159,130 6/1950 Auger D9/347 X
- D. 168,524 12/1952 Thomas D6/467
- D. 246,216 11/1977 Heumann D6/484
- D. 250,313 11/1978 Miller D6/484

- D. 257,438 10/1980 Tsuyuki D6/467 X
- D. 280,162 8/1985 Bromley D6/484
- D. 282,420 2/1986 Melland D6/484
- 3,163,289 12/1964 Laffkas et al. D9/347 X
- 3,877,603 4/1975 Holz D7/38 X

Primary Examiner—Bruce W. Dunkins
Attorney, Agent, or Firm—Howard M. Herriot

[57] CLAIM

The ornamental design for a display table or similar article, as shown and described.

DESCRIPTION

FIG. 1 is a top plan view of a table embodying my new design;

FIG. 2 is a perspective view thereof;

FIG. 3 is a front elevational view thereof;

FIG. 4 is a rear elevational view thereof;

FIG. 5 is a right side elevational view thereof; and

FIG. 6 is a left side elevational view thereof.

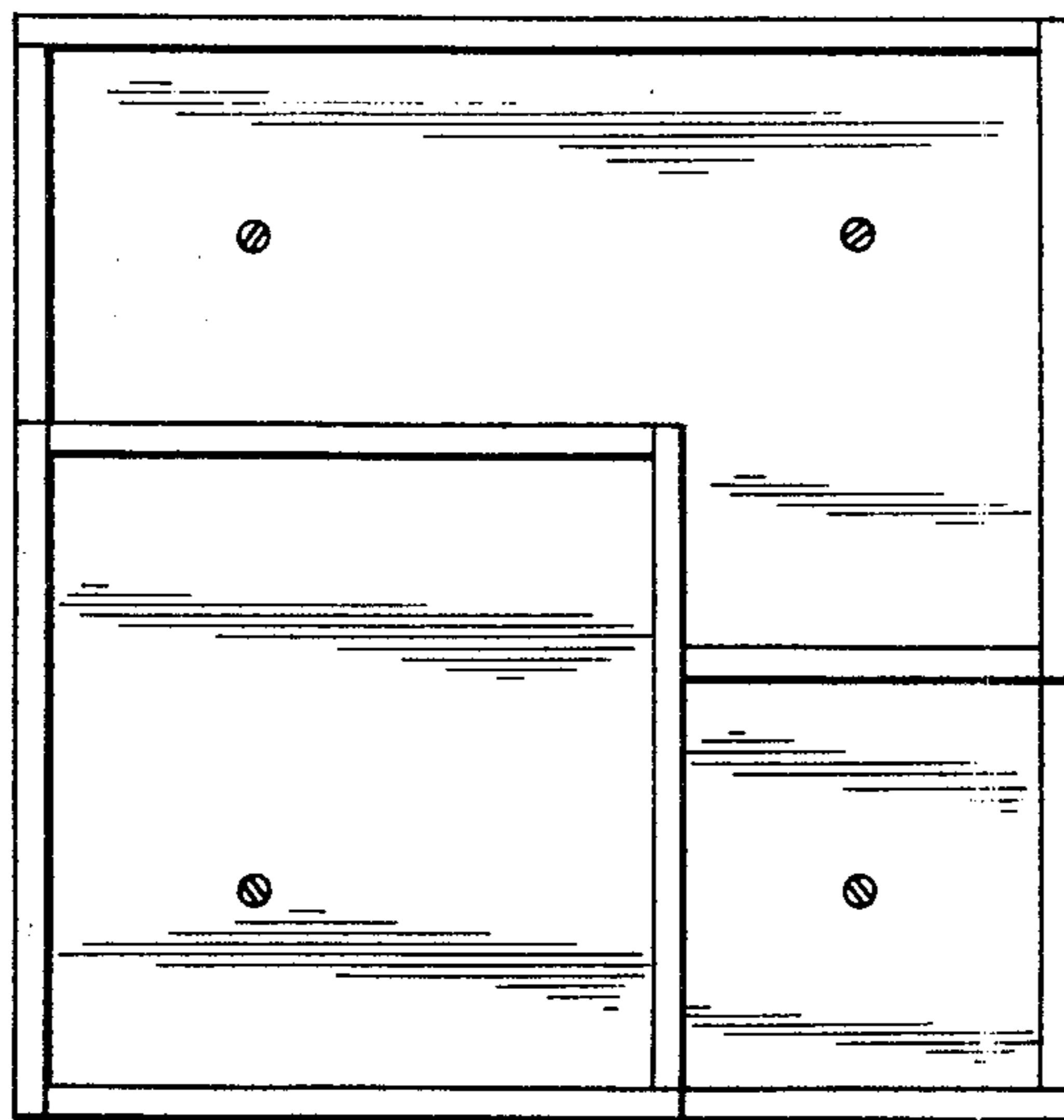

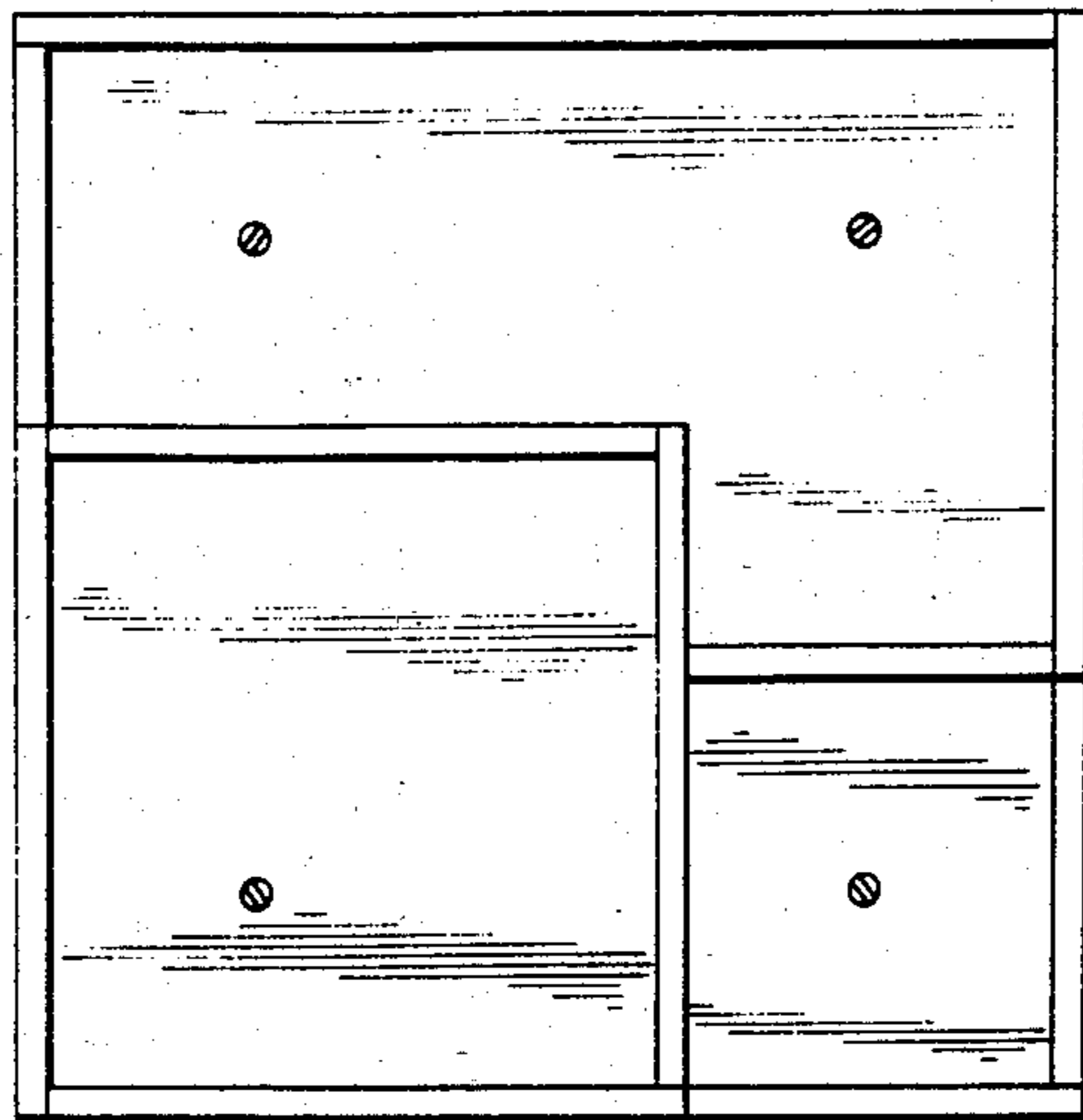

FIG. 1

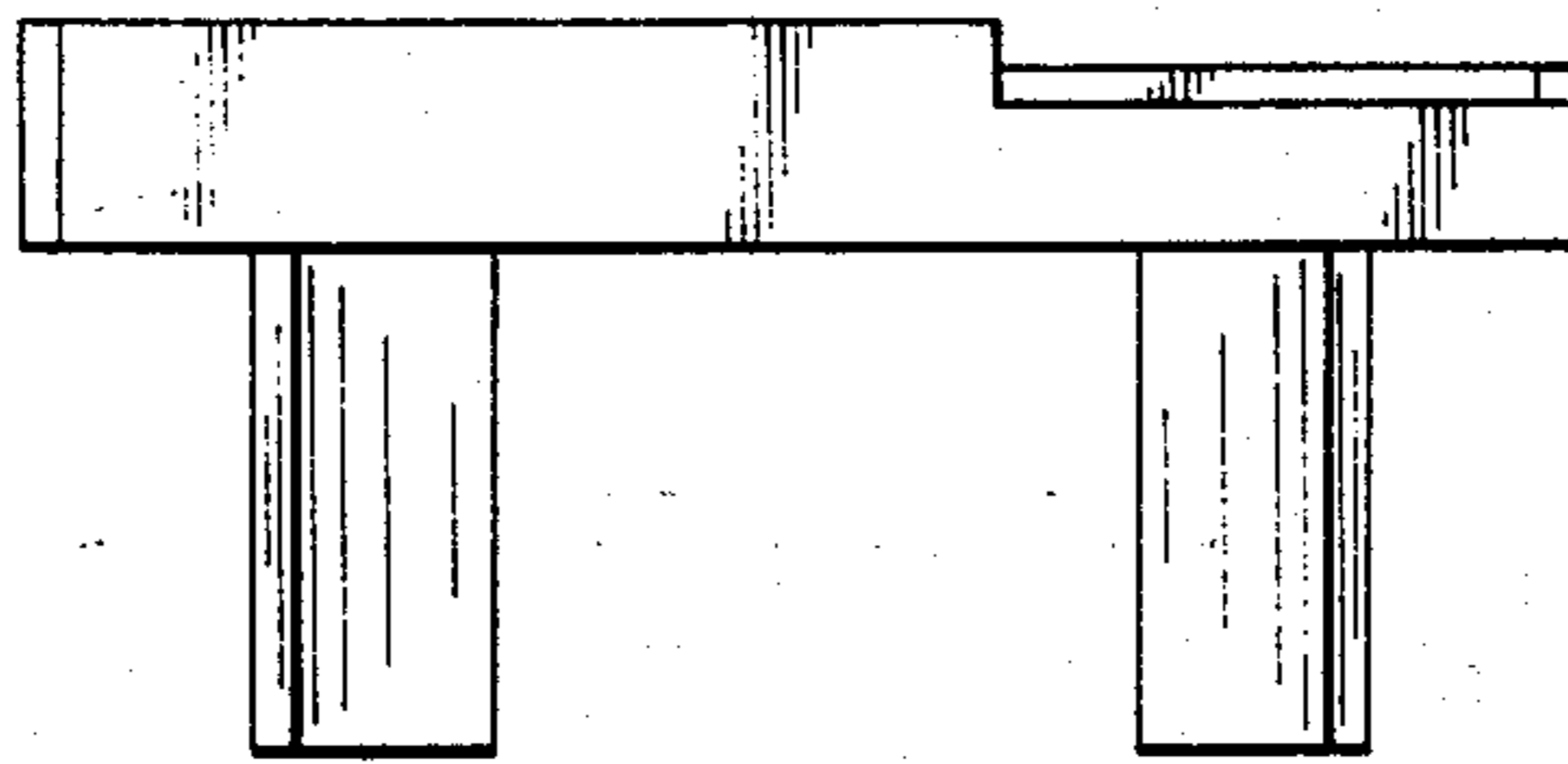

FIG. 3

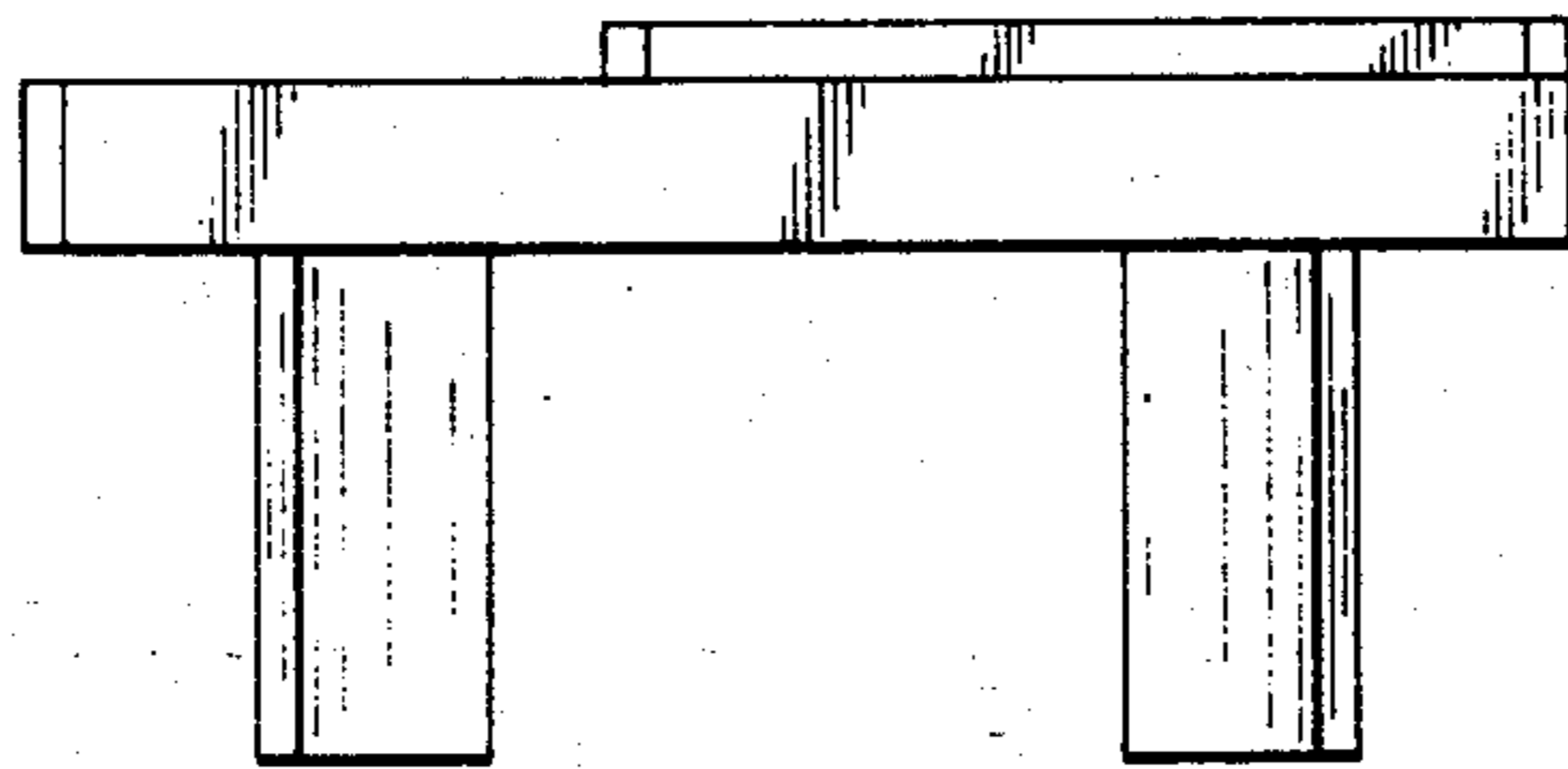

FIG. 4

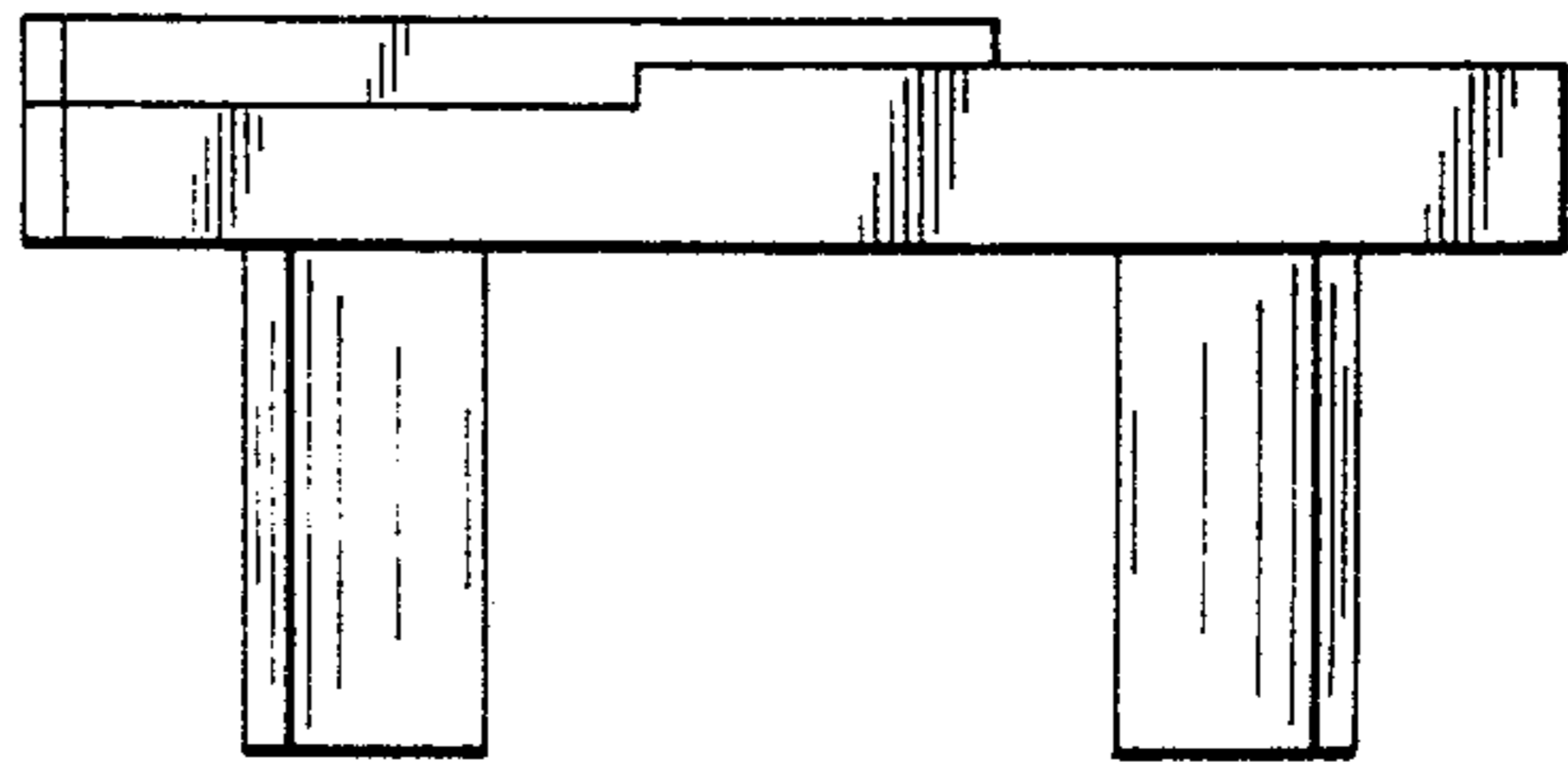

FIG. 5

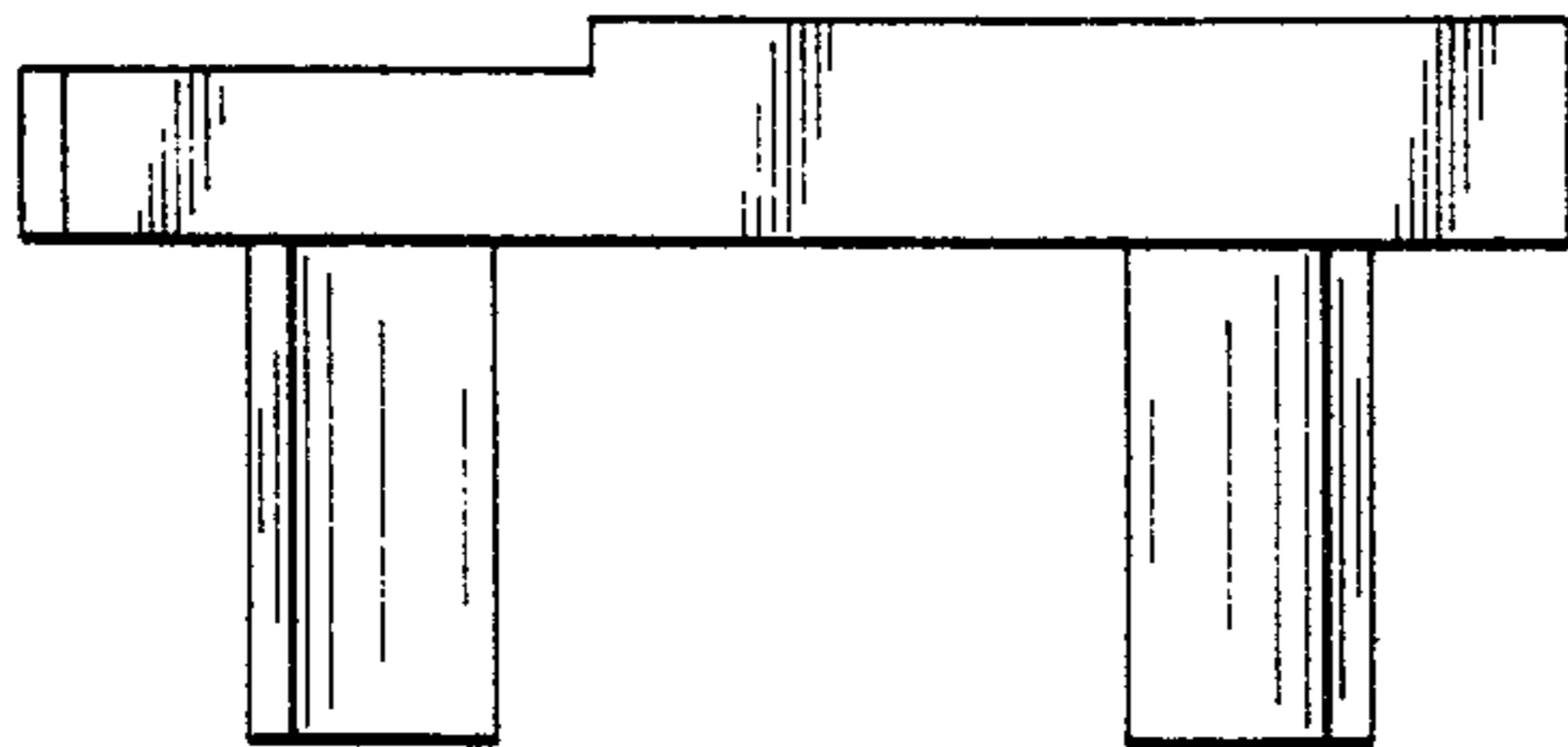

FIG. 6

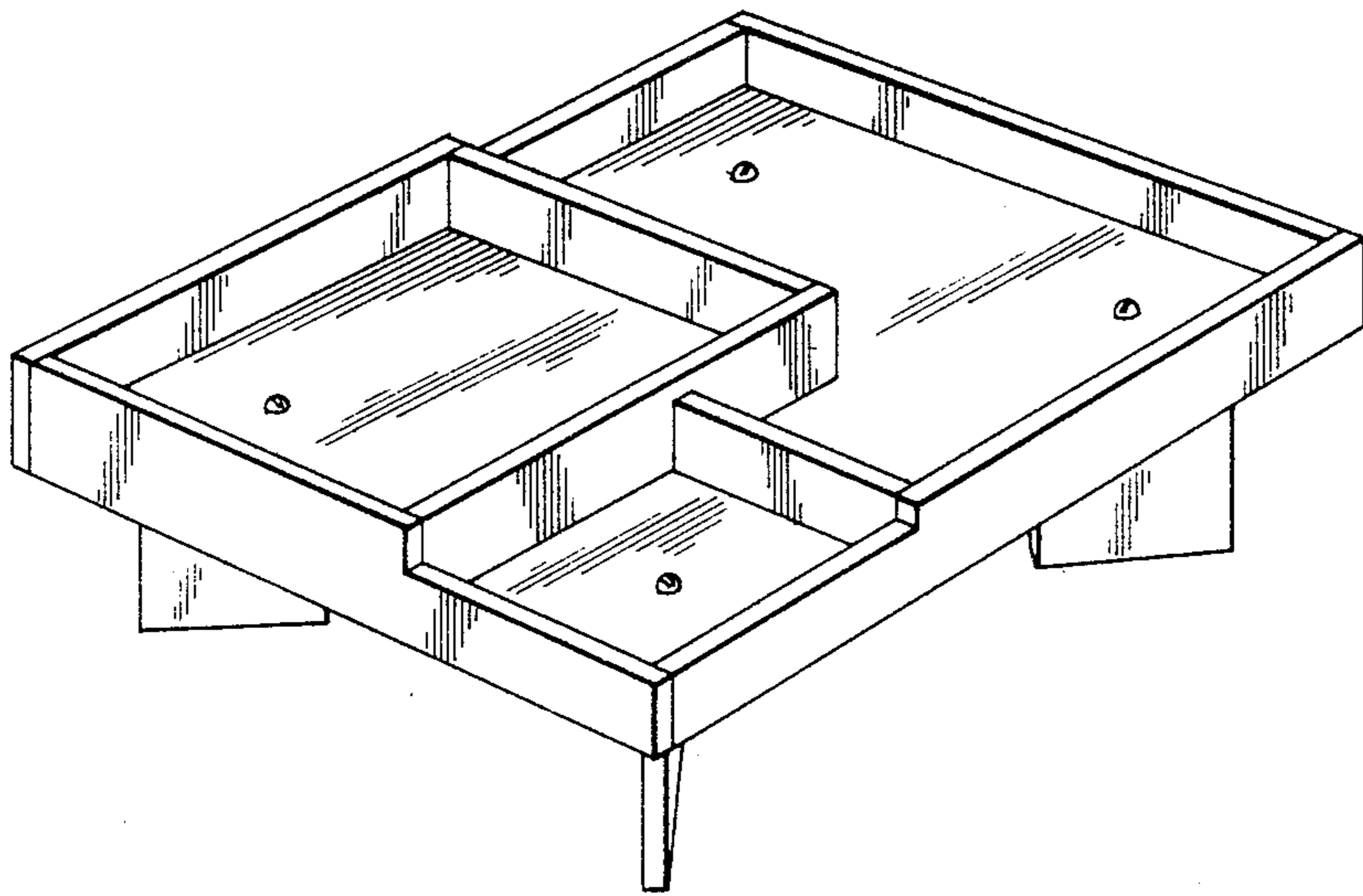

FIG. 2