

[54] **CHAIR**

[75] **Inventor: Moses R. Schultz, Barto, Pa.**

[73] **Assignee: Melamede and Company, Inc., New York, N.Y.**

[*] **Notice: The portion of the term of this patent subsequent to Mar. 17, 2001 has been disclaimed.**

[**] **Term: 14 Years**

[21] **Appl. No.: 592,356**

[22] **Filed: Mar. 19, 1984**

[52] **U.S. Cl. D6/366**

[58] **Field of Search D6/334, 364, 365, 366, D6/367; 297/287, 296, 300, 301, 311**

[56] **References Cited**

U.S. PATENT DOCUMENTS

D. 275,053 8/1984 Stephens D6/366

D. 279,443 7/1985 Diffrient D6/502 X

OTHER PUBLICATIONS

Abitare Magazine Supplement, Mar. 1979, p. 47, Chair, top center.

Steelcase Catalog, p. 12, Chair No. 454-561M.

Primary Examiner—Bruce W. Dunkins
Attorney, Agent, or Firm—Amster, Rothstein & Ebenstein

[57] **CLAIM**

The ornamental design for a chair, as shown.

DESCRIPTION

FIG. 1 is a front elevational view of a chair showing the new design;

FIG. 2 is a left side elevational view thereof;

FIG. 3 is a right side elevational view thereof;

FIG. 4 is a rear elevational view thereof;

FIG. 5 is a top plan view thereof; and

FIG. 6 is a bottom plan view thereof.

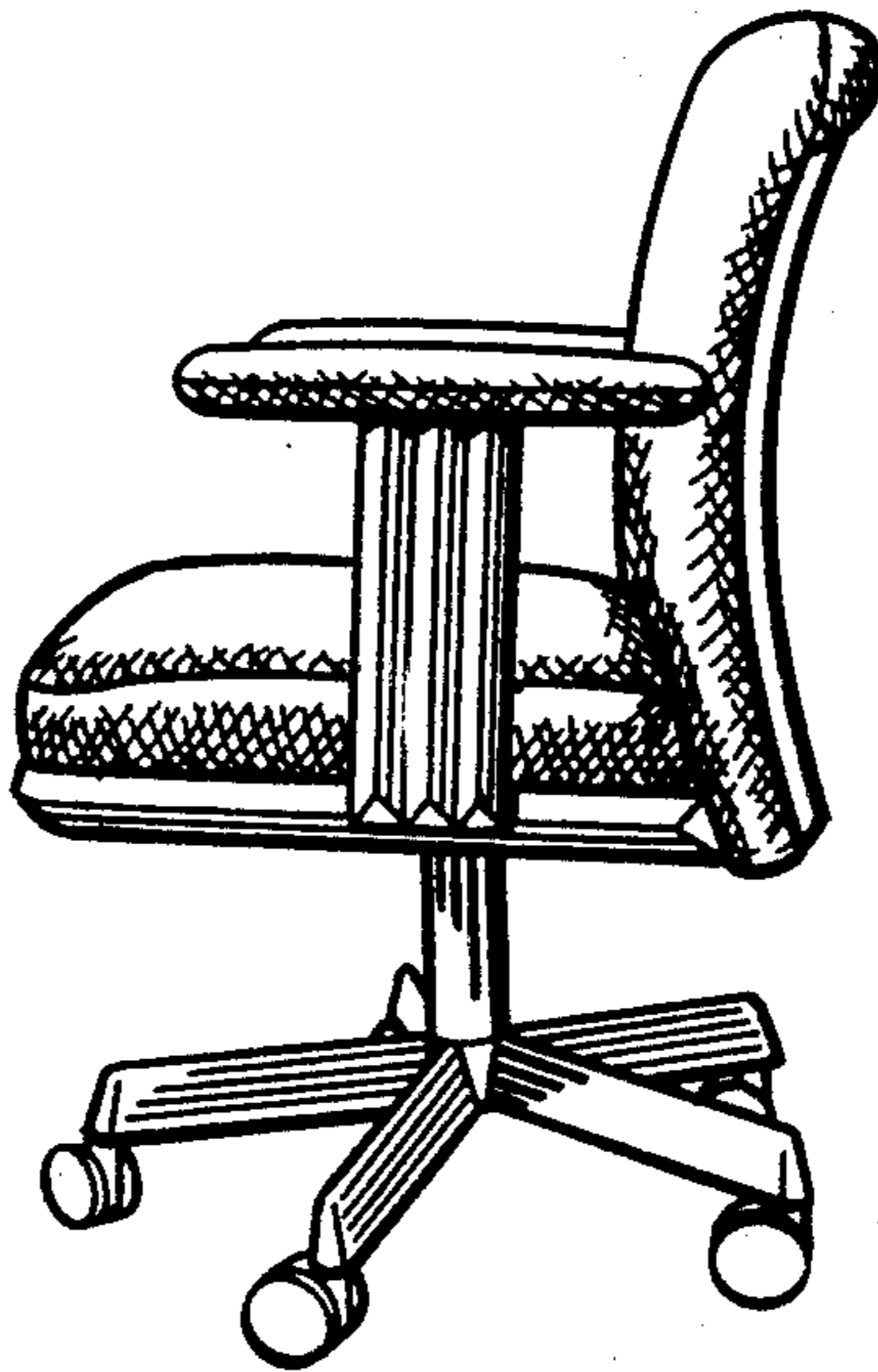

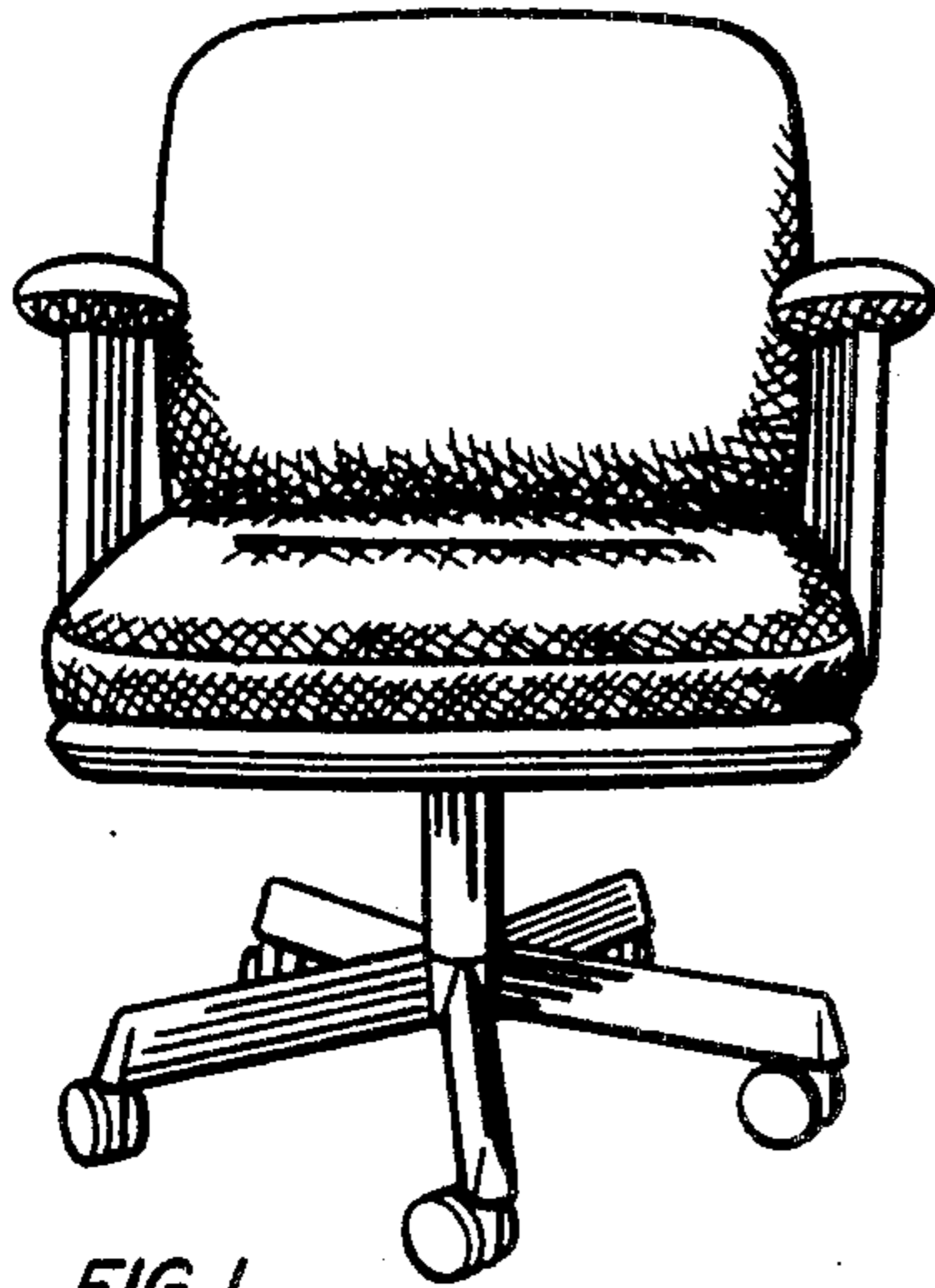

FIG. 1.

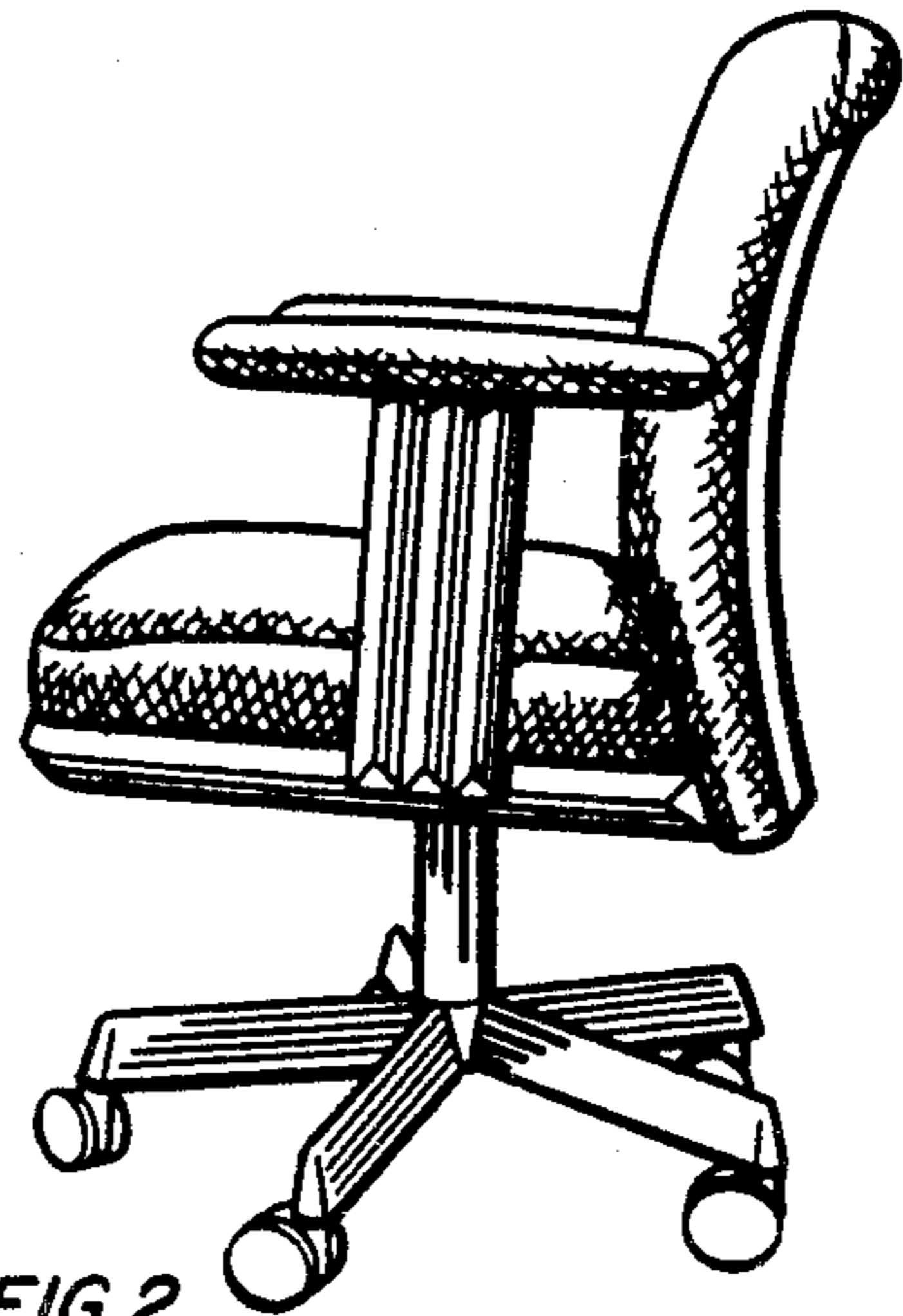

FIG. 2.

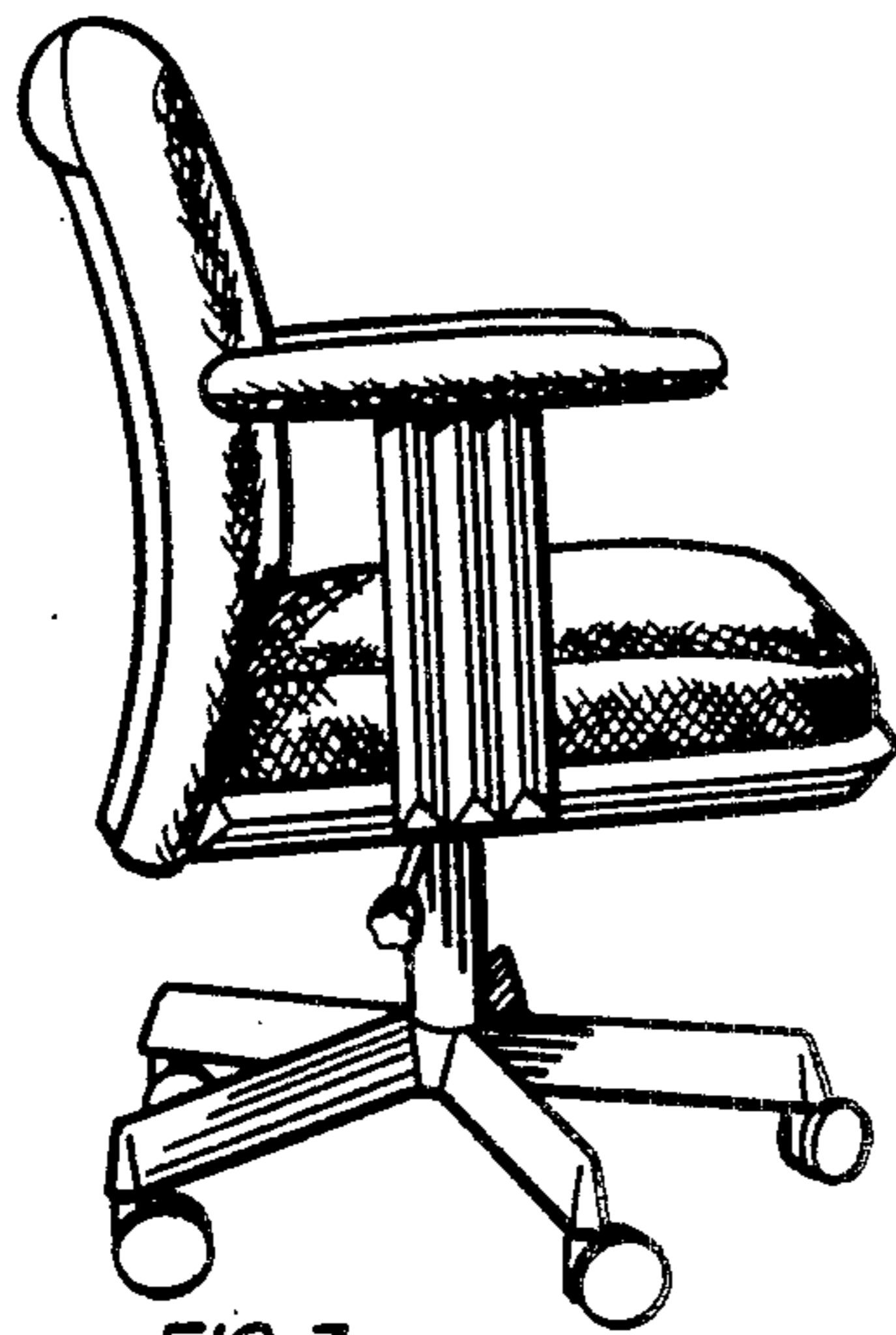

FIG. 3.

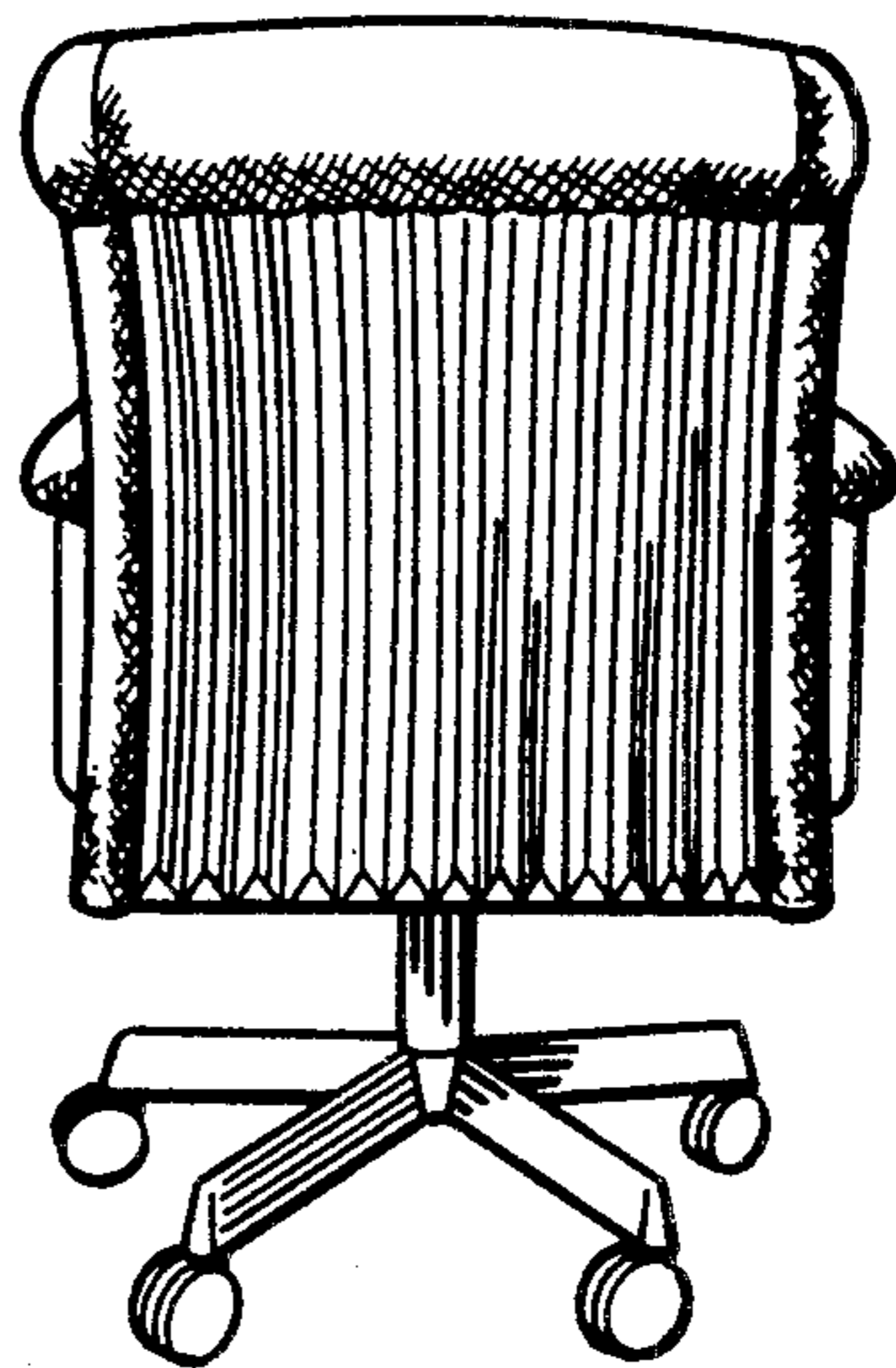

FIG. 4.

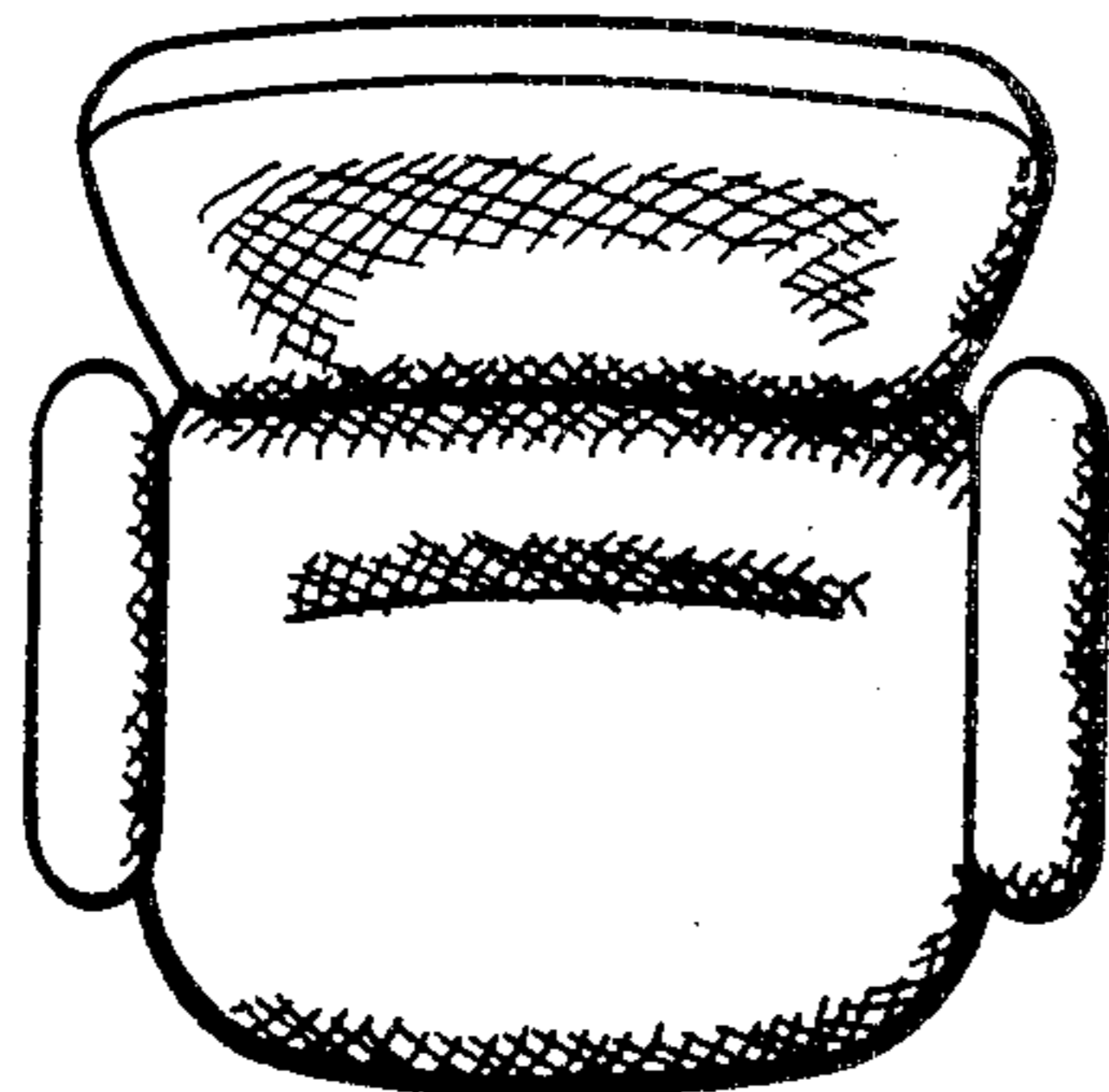

FIG. 5.

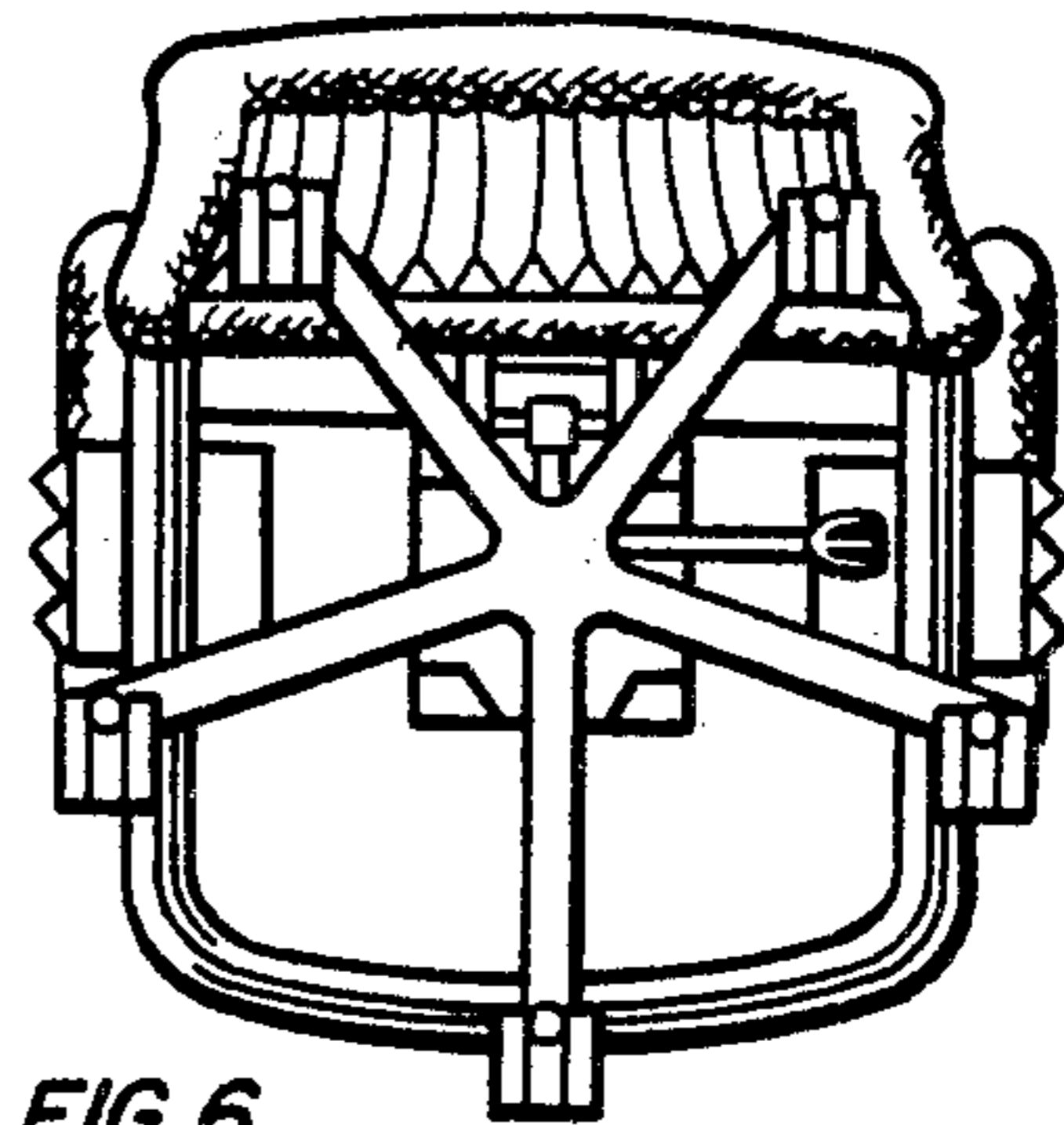

FIG. 6.