

[54] **SPRAYING WAND**

[76] Inventor: **Robert W. Hengesbach**, 7886 Mentor Rd., Mentor, Ohio 44060

[\*\*] Term: **14 Years**

[21] Appl. No.: **605,648**

[22] Filed: **Apr. 30, 1984**

[52] U.S. Cl. .... **D23/35**

[58] Field of Search ..... **D23/17, 18, 34-39; 239/531, 532, 567, 568, 592**

[56] **References Cited**

**U.S. PATENT DOCUMENTS**

D. 141,623	6/1945	Thompson .....	D23/35
D. 230,152	1/1974	Froehlke .....	D23/34
D. 234,845	4/1975	Davis .....	D23/17
D. 270,368	8/1983	Grime .....	D23/18
528,144	10/1894	Cadwell .	
994,780	6/1911	Olney .	
1,988,979	1/1935	Campbell .	
2,125,573	8/1938	Kelley, Jr. .	
2,302,799	11/1942	Peterson .	
2,544,558	3/1951	MacGregor .....	239/568 X
2,577,465	12/1951	Jones et al. .	
3,032,929	3/1961	Glesener .	
3,038,668	6/1962	Handberg .....	239/568 X
3,447,753	6/1969	Proctor et al. ....	D23/17 X
3,727,841	4/1973	Hengesbach .	
4,369,607	1/1983	Bruggeman et al. .	
4,471,911	9/1984	Hengesbach .	
4,494,699	1/1985	Hengesbach .	

**FOREIGN PATENT DOCUMENTS**

1177968	4/1959	France .
285398	12/1952	Switzerland .

**OTHER PUBLICATIONS**

Brochure, Tri-Con, Inc., 4 pages, dated 1/1/1977, entitled: We Make the System.

Brochure, Spraying Systems Co., Catalog 27, 90 pages, 1978, entitled Spray Nozzles and Accessories.

Brochure, Spraying Systems Co., Bulletin 179F, 8 pages, 1971, entitled Spray Nozzles, Spray Guns, Valves and Accessories.

*Primary Examiner*—James R. Largen

*Attorney, Agent, or Firm*—David A. Burge

[57] **CLAIM**

The ornamental design for a spraying wand, as shown and described.

**DESCRIPTION**

FIG. 1 is a side elevational view of a spray wand showing my new design;  
 FIG. 2 is a top plan view thereof;  
 FIG. 3 is a bottom plan view thereof;  
 FIG. 4 is an enlarged forshortened side elevational view taken from plane 4—4 of FIG. 2;  
 FIG. 5 is an enlarged forshortened side elevational view taken from plane 5—5 on FIG. 2;  
 FIG. 6 is an enlarged forshortened side elevational view taken from plane 6—6 on FIG. 2;  
 FIG. 7 is an enlarged forshortened side elevational view taken from plane 7—7 on FIG. 2;  
 FIG. 8 is a cross sectional view taken on line 8—8 of FIG. 4;  
 FIG. 9 is a cross sectional view taken on line 9—9 of FIG. 4;  
 FIG. 10 is a cross sectional view taken on line 10—10 of FIG. 4;  
 FIG. 11 is a side elevational view of a modified form of the spray wand shown in FIG. 1;  
 FIG. 12 is an enlarged forshortened perspective view of FIG. 11;  
 FIG. 13 is a plan view taken from plane 13—13 on FIG. 11;  
 FIG. 14 is a plan view taken from plane 14—14 on FIG. 11;  
 FIG. 15 is an enlarged forshortened side elevational view taken from plane 15—15 on FIG. 13;  
 FIG. 16 is an enlarged forshortened side elevational view taken from plane 16—16 on FIG. 11;  
 FIG. 17 is an enlarged forshortened side elevational view taken from plane 17—17 on FIG. 13;  
 FIG. 18 is an enlarged forshortened side elevational view taken from plane 18—18 on FIG. 13;  
 FIG. 19 is a cross sectional view taken on line 19—19 of FIG. 15;  
 FIG. 20 is a cross sectional view taken on line 20—20 of FIG. 15;  
 FIG. 21 is a cross sectional view taken on line 21—21 of FIG. 15.  
 It is to be understood that the connecting tube has been broken away in FIGS. 4 through 7, 11 and 15 through 18 for convenience of illustration.

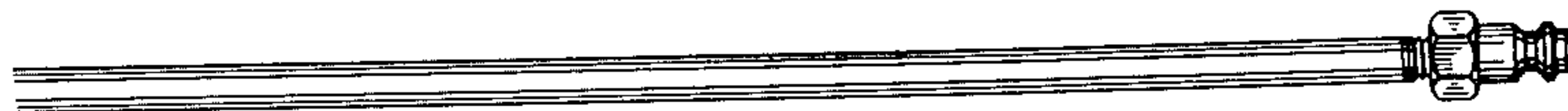

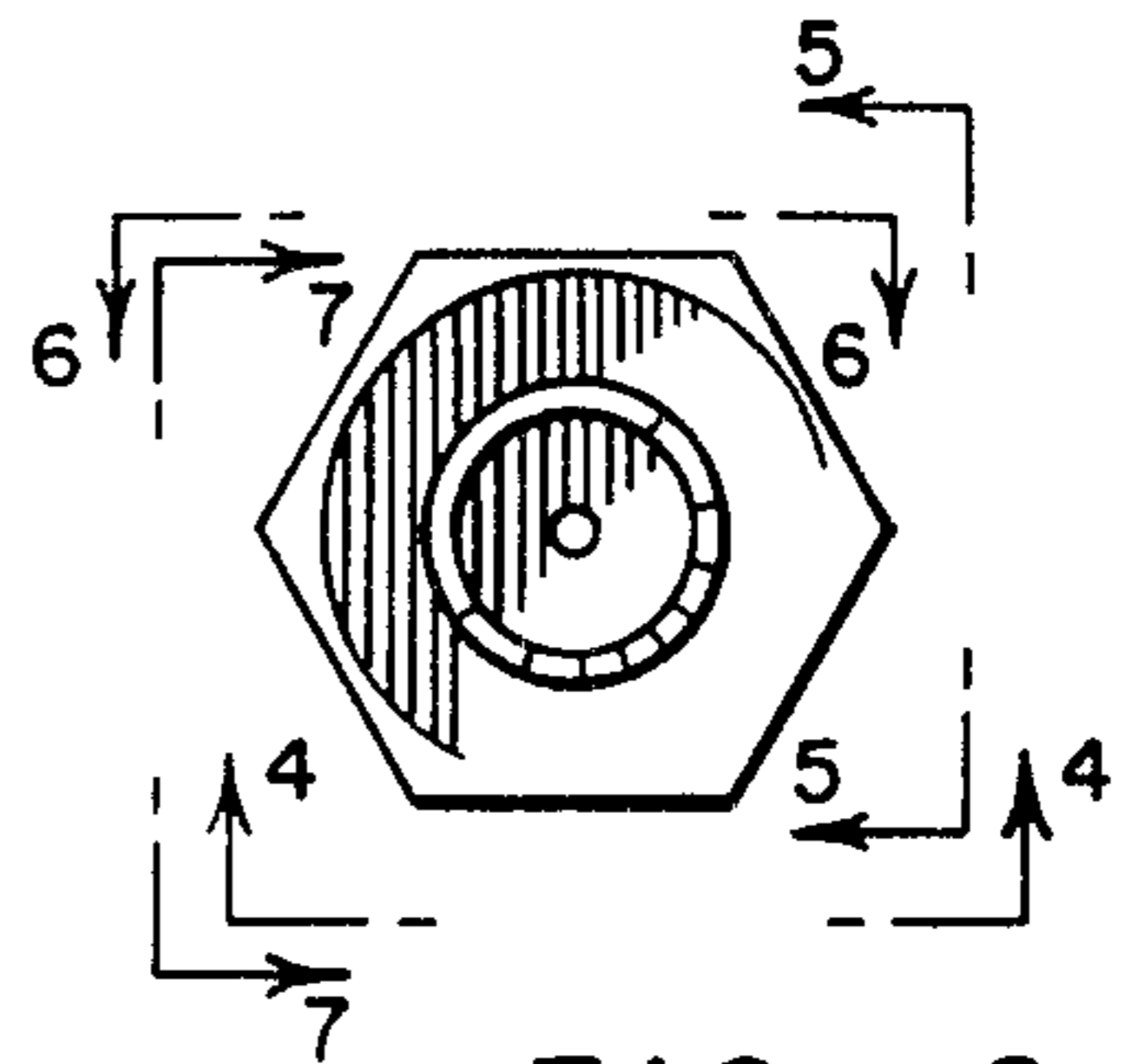
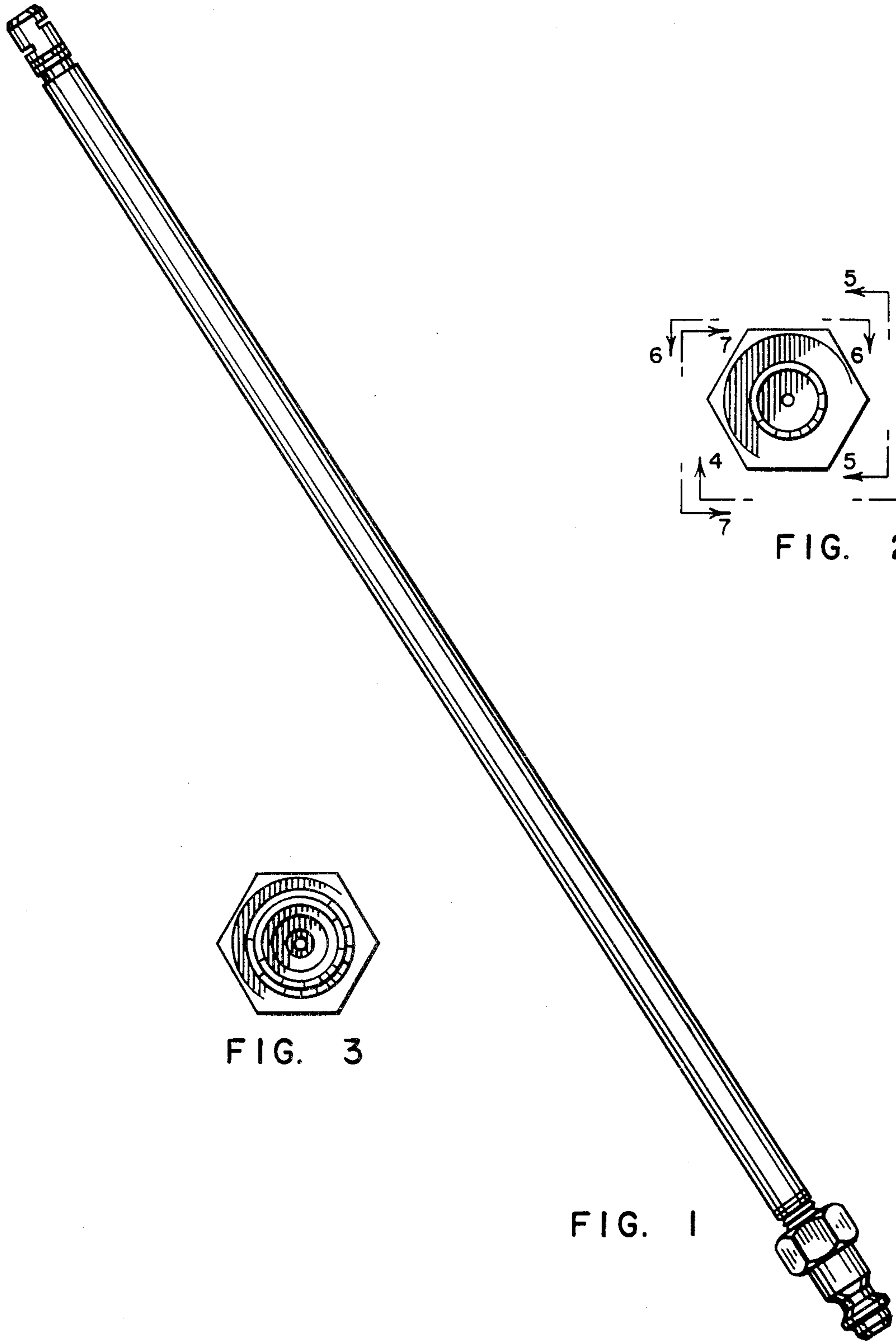

FIG. 2

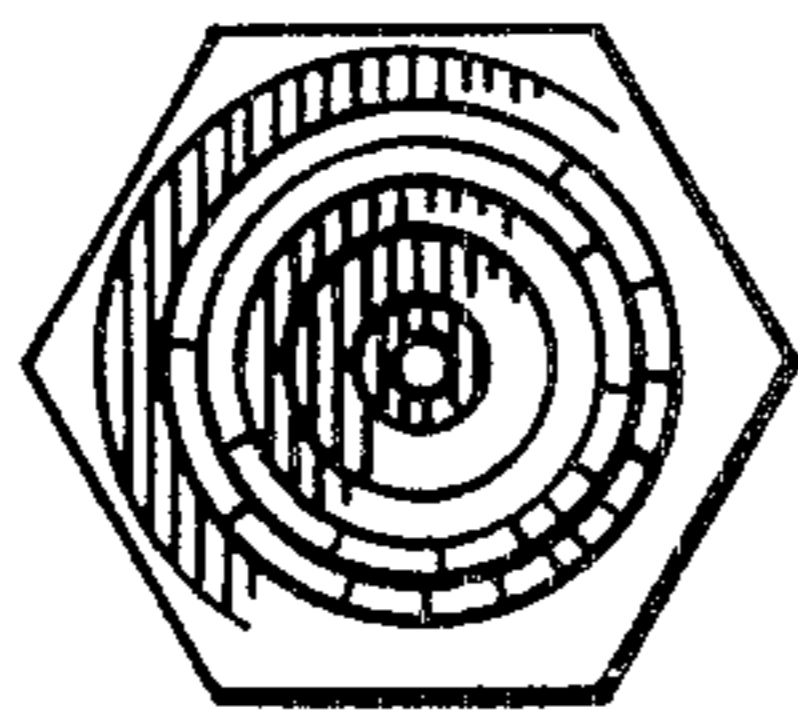

FIG. 3

FIG. 1

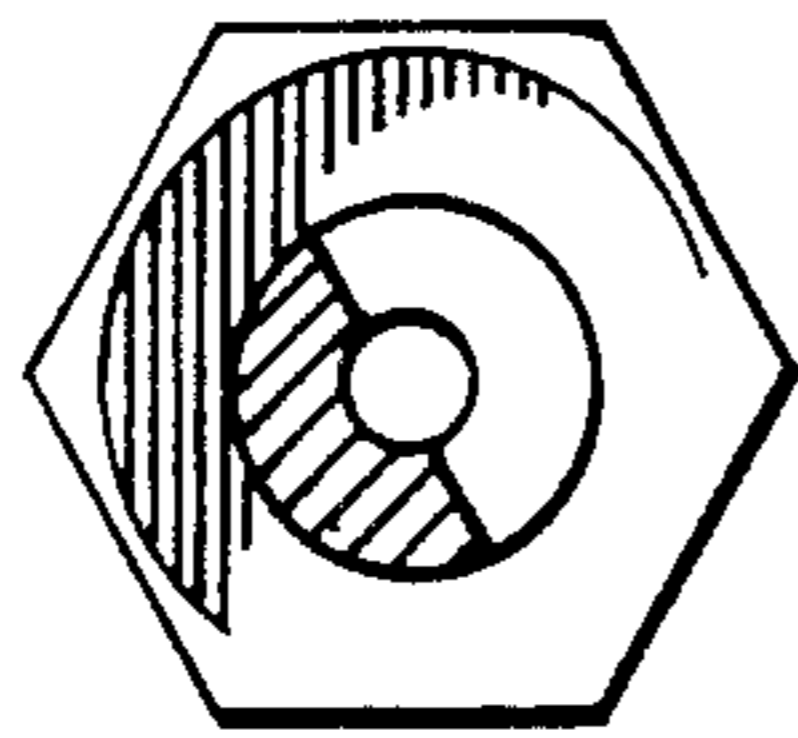

FIG. 8

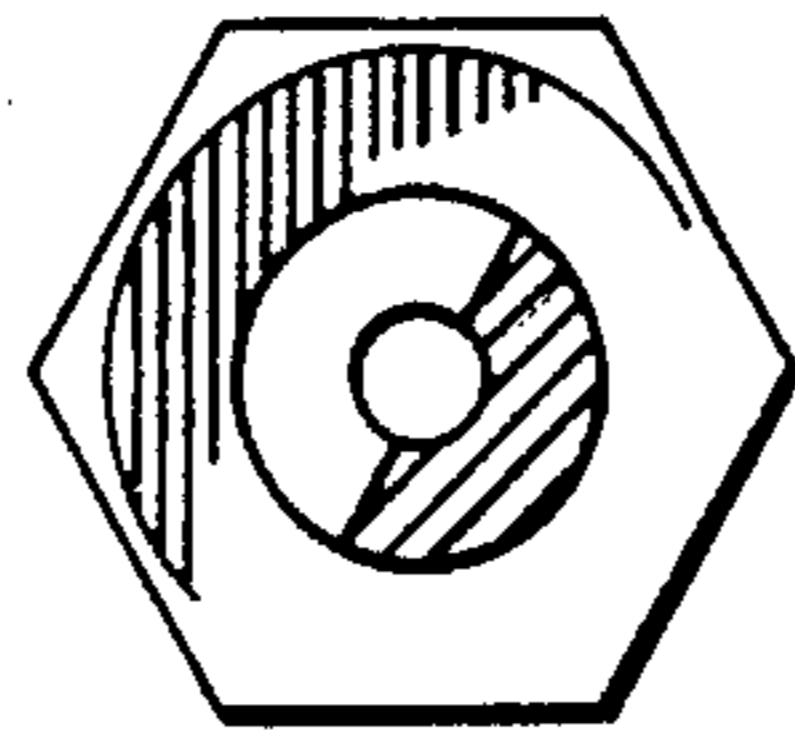

FIG. 9

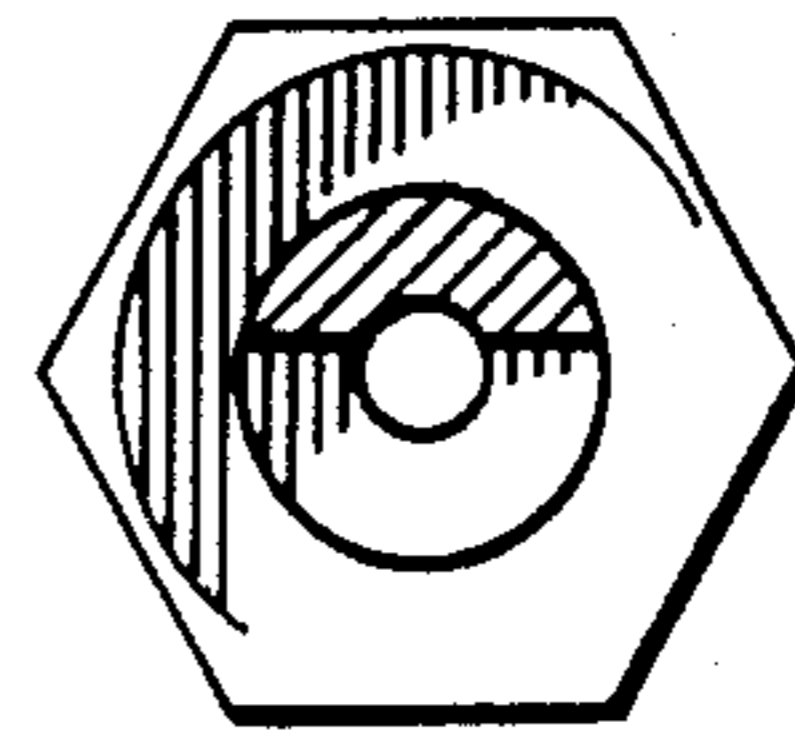

FIG. 10

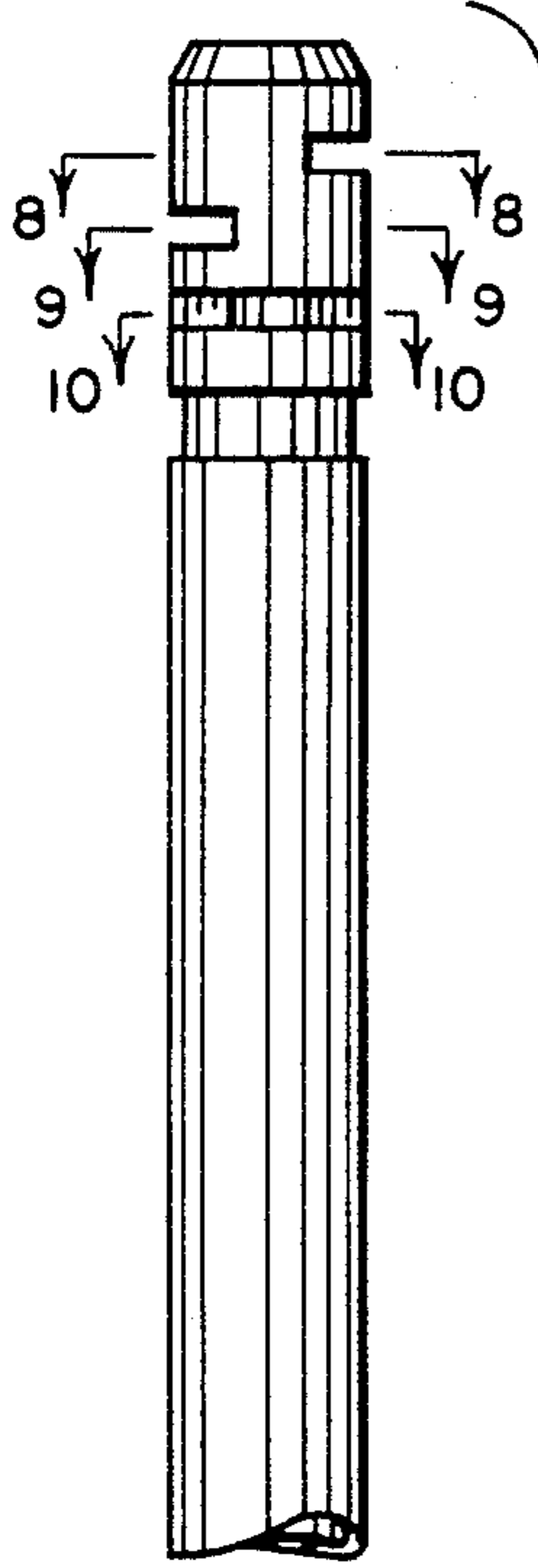

FIG. 4



FIG. 5



FIG. 6



FIG. 7

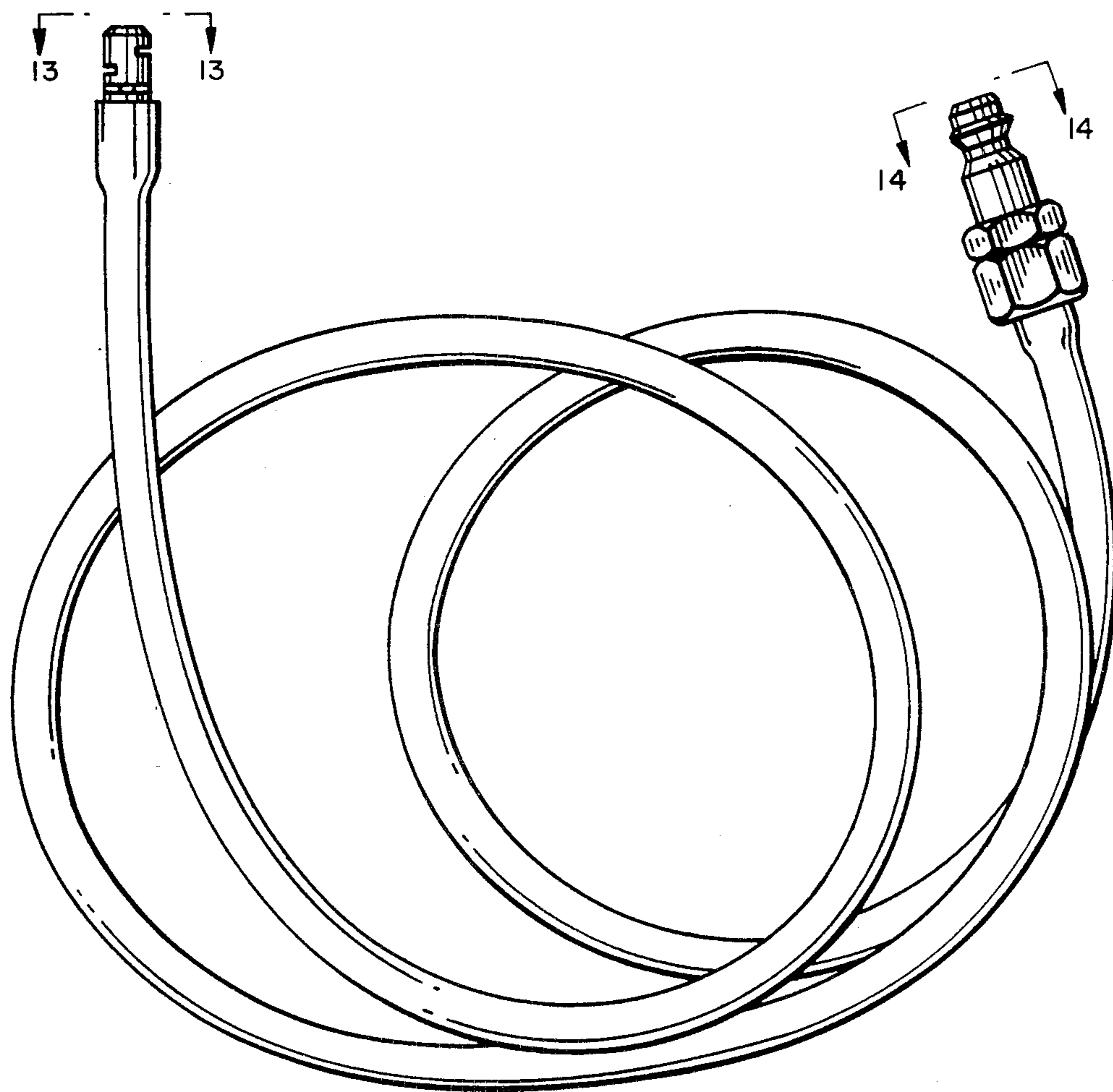

FIG. 11

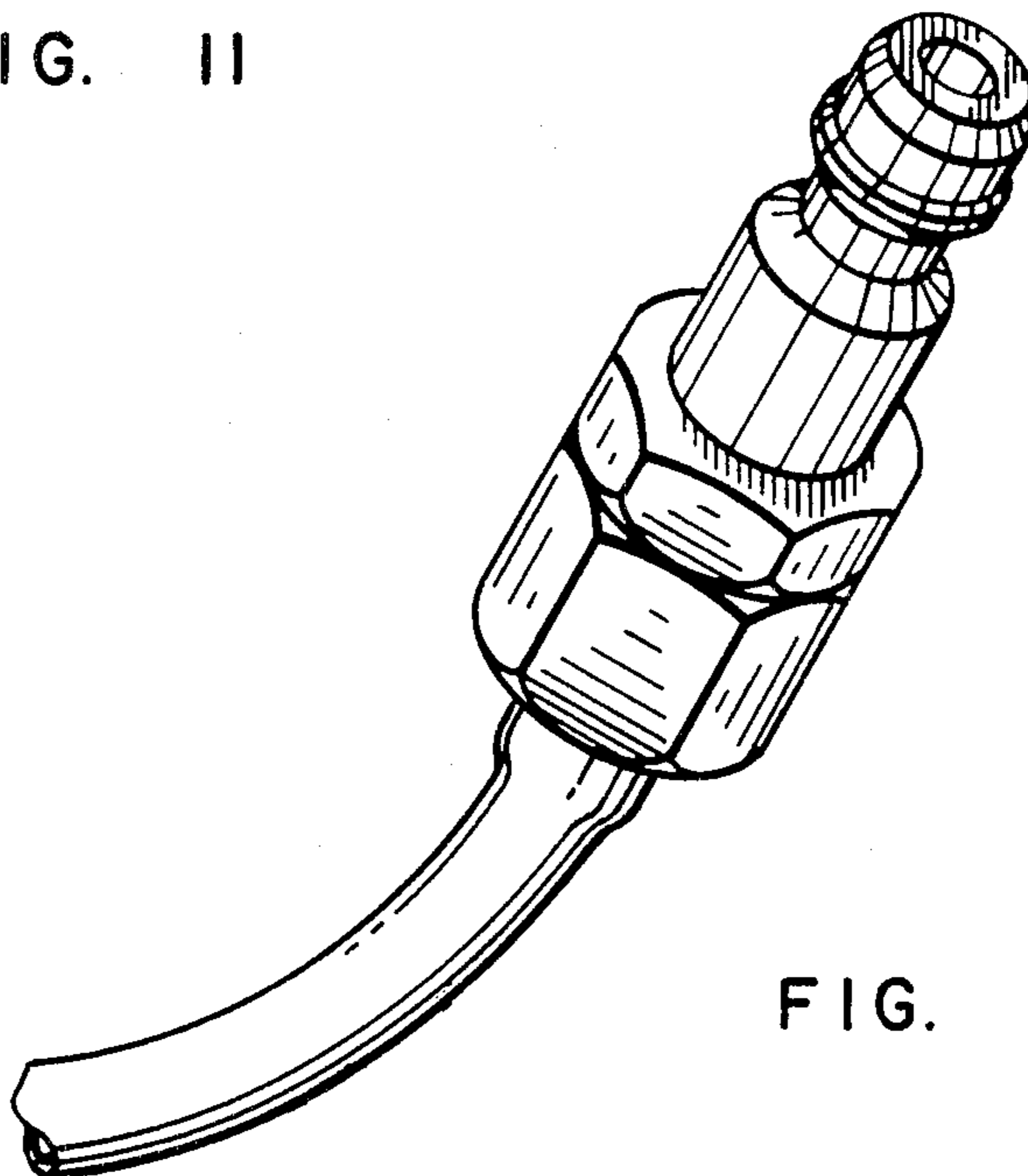
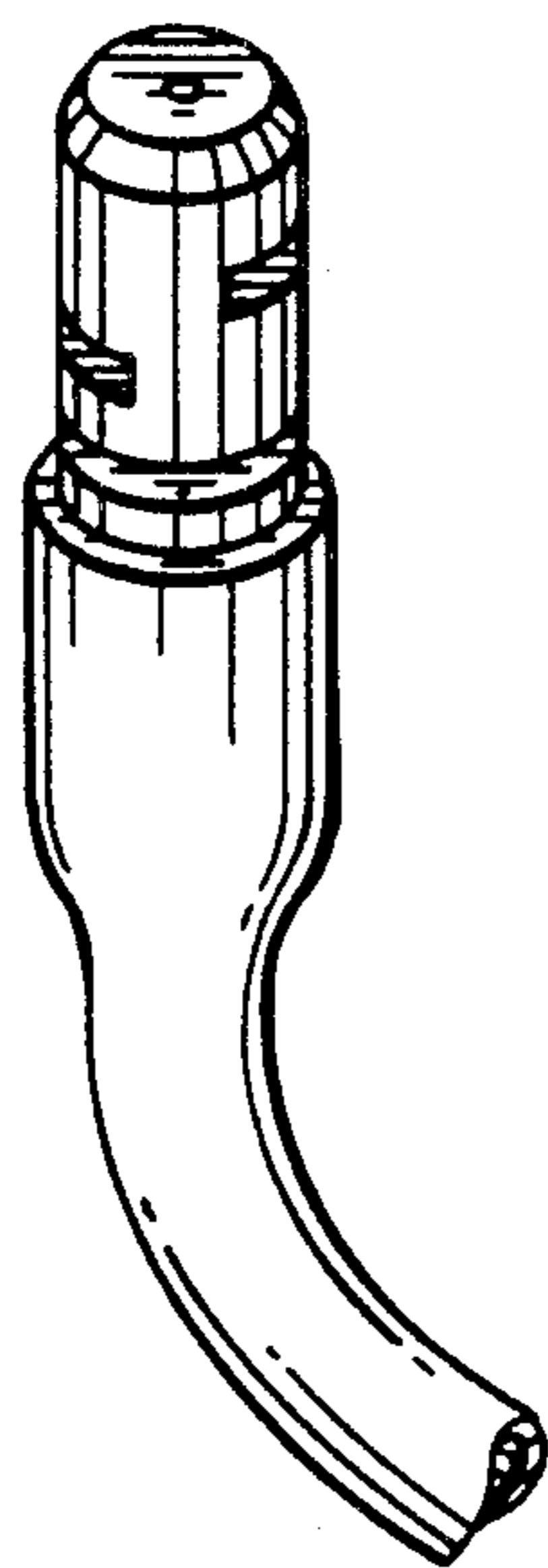

FIG. 12

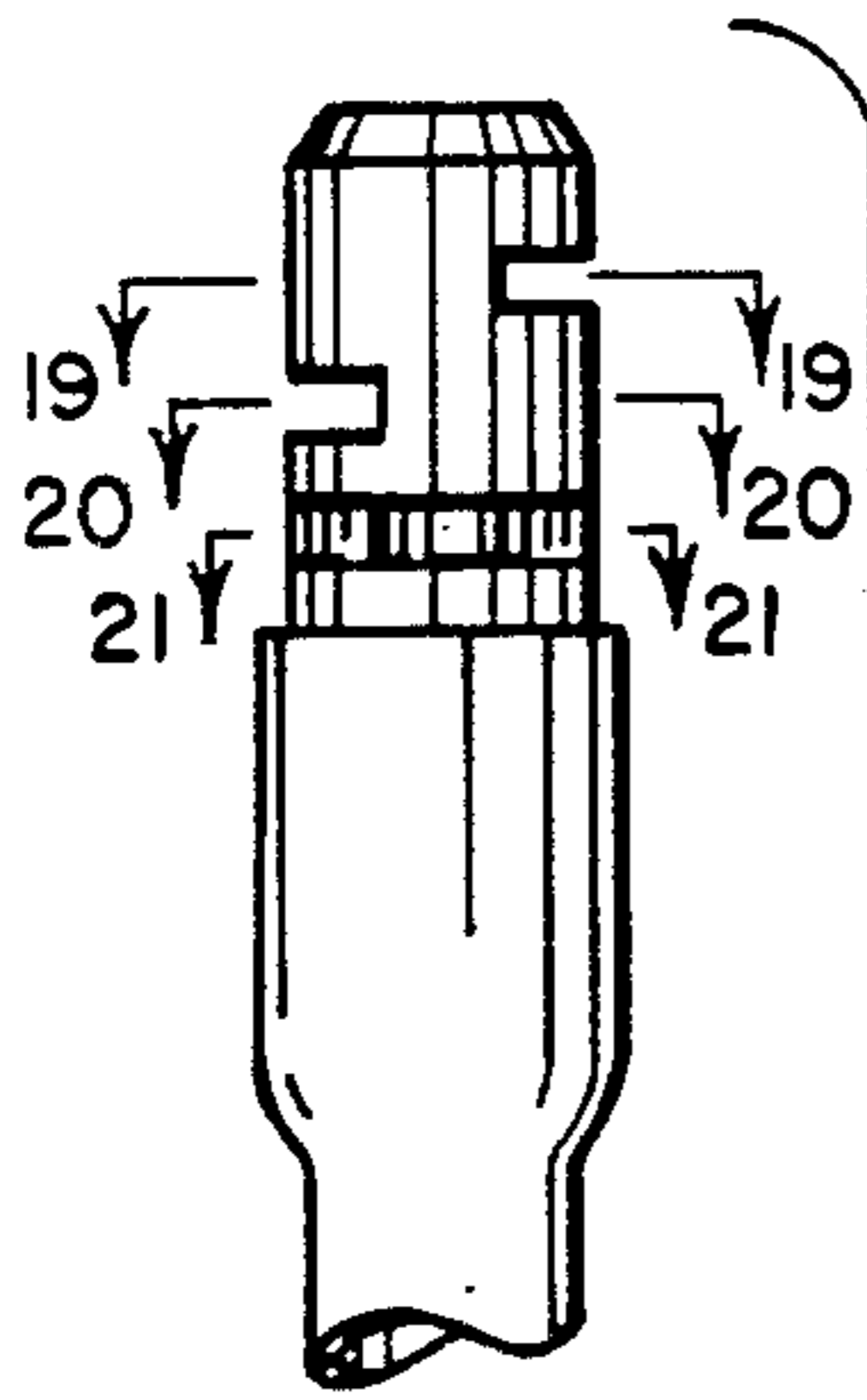

FIG. 15

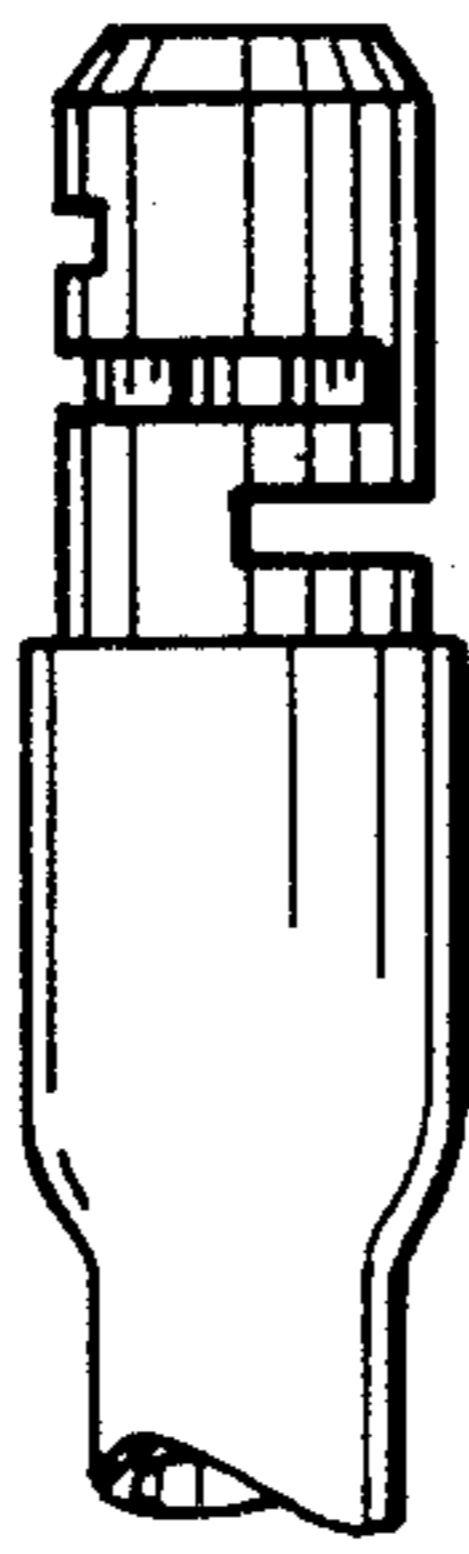

FIG. 16

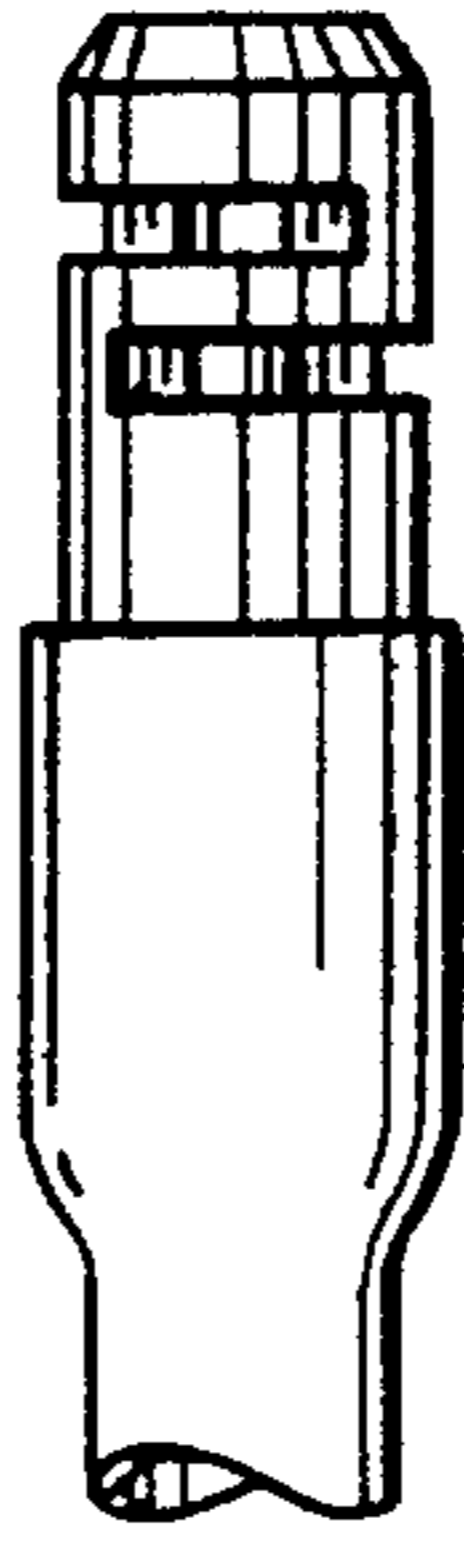

FIG. 17

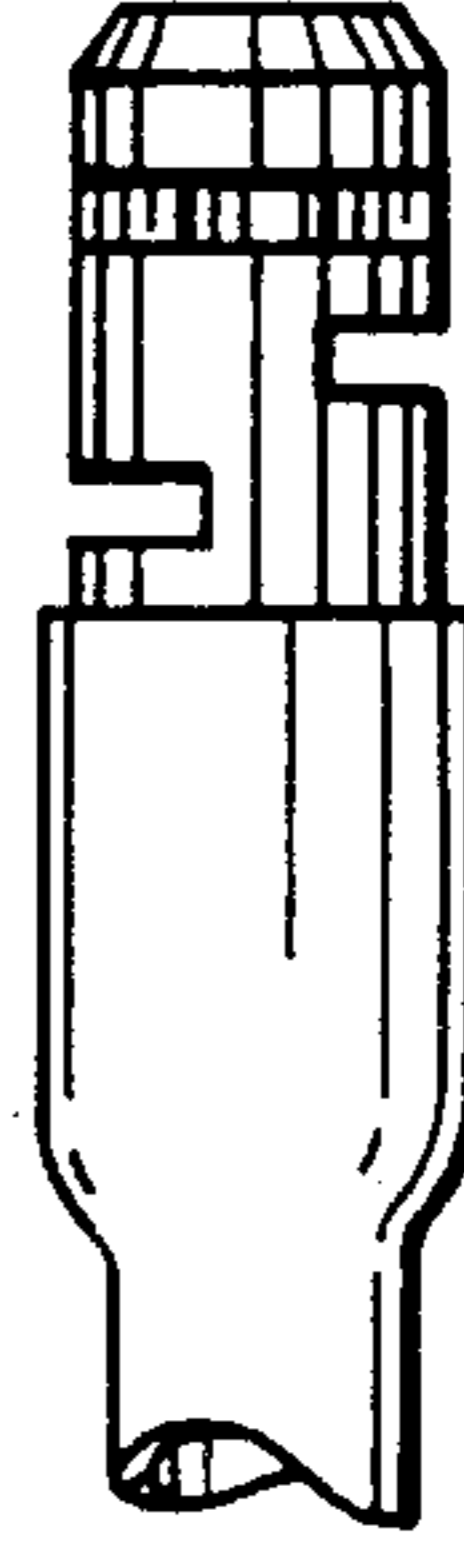

FIG. 18

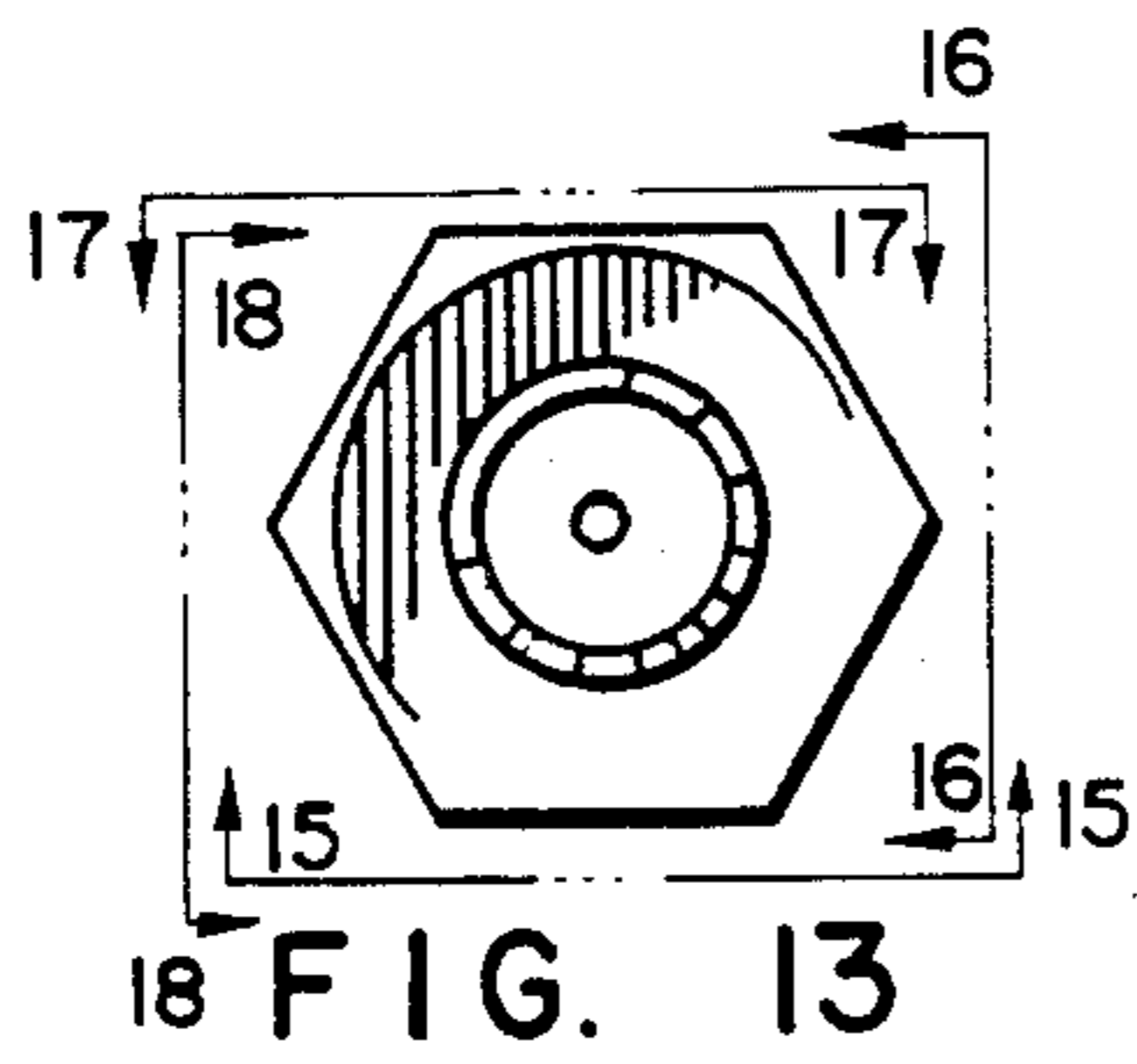
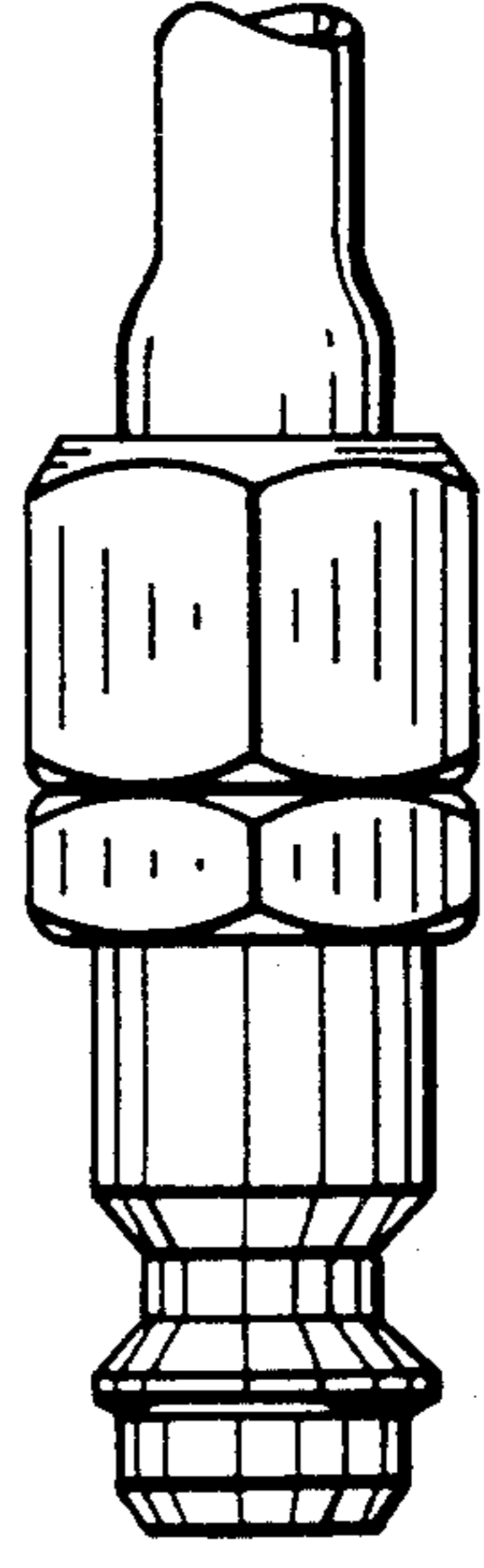
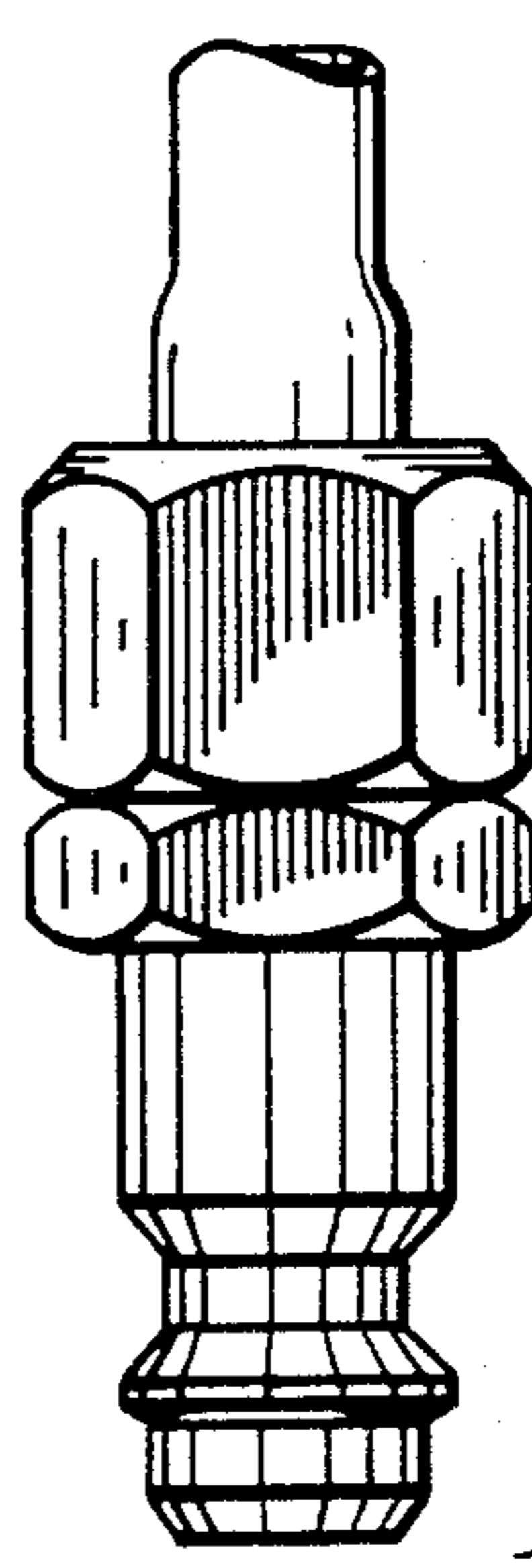
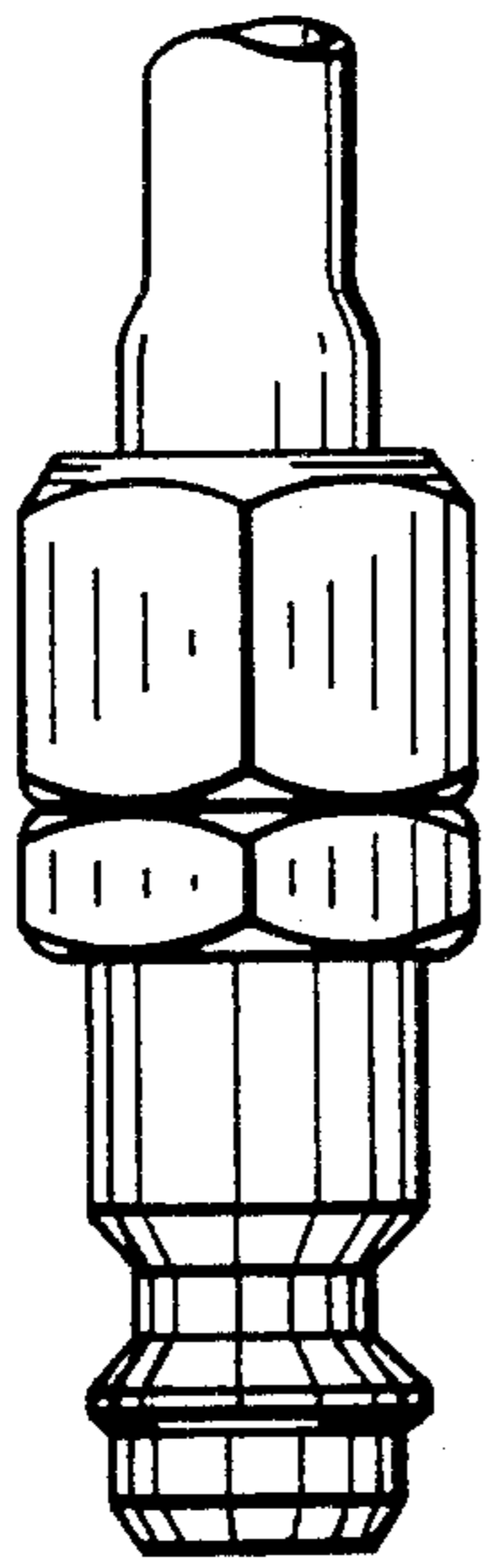
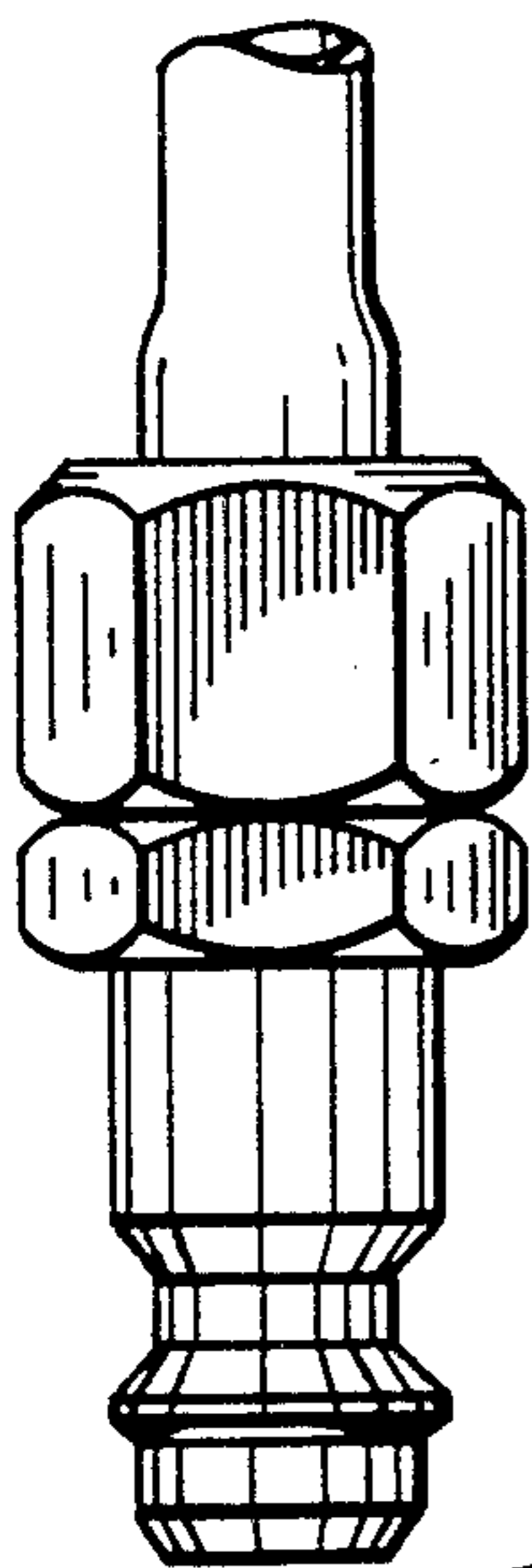

FIG. 13

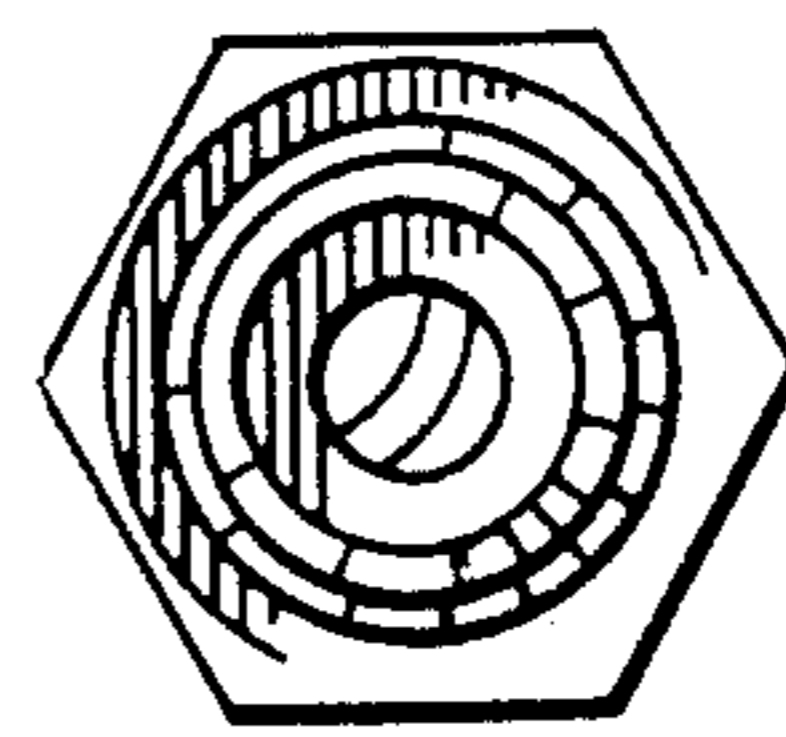

FIG. 14

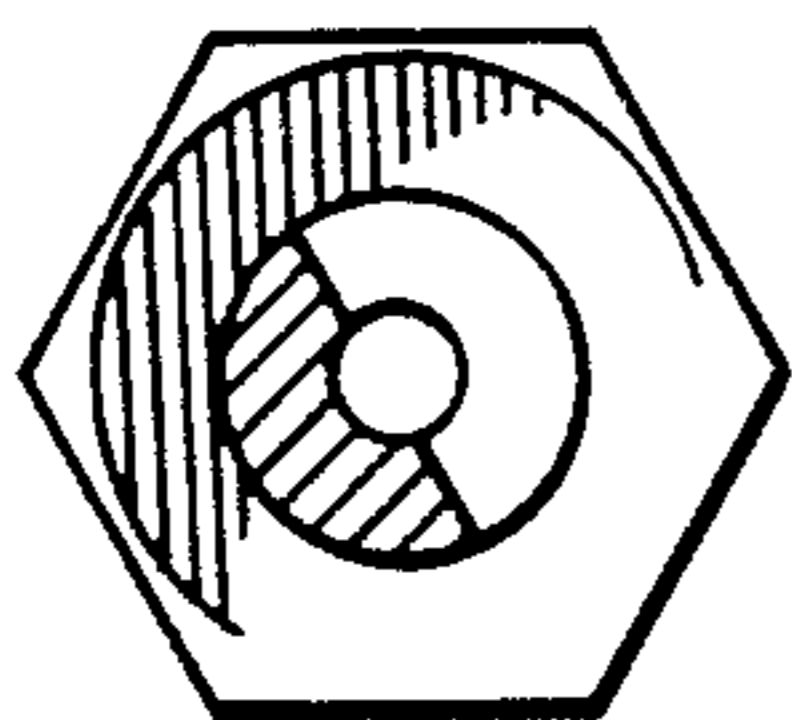

FIG. 19

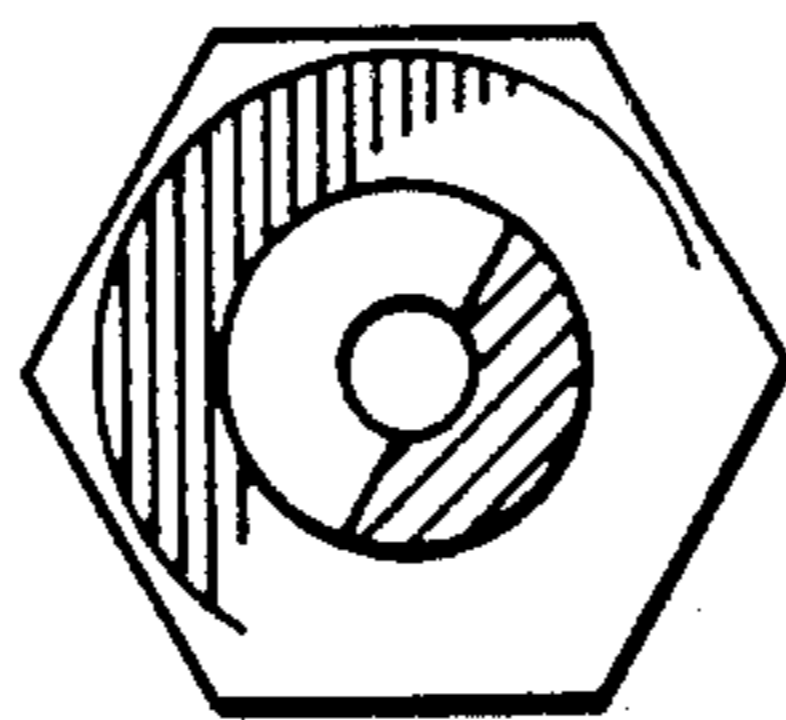

FIG. 20

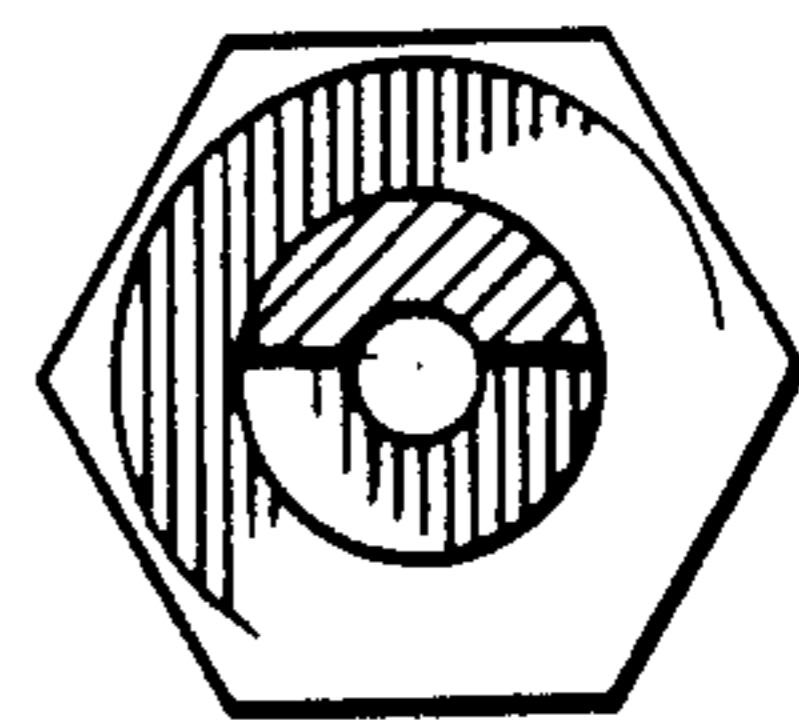

FIG. 21