

- [54] COMBINED CONTAINER AND DISPLAY CASE FOR DENTAL BOTTLES
- [75] Inventors: William J. Blatherwick, Hamilton Square; Leslie Hamilton, Trenton; Robert D. Holewinski, Lakehurst, all of N.J.
- [73] Assignee: Johnson & Johnson Dental Products, East Windsor, N.J.
- [\*\*] Term: 14 Years
- [21] Appl. No.: 668,524
- [22] Filed: Nov. 5, 1984
- [52] U.S. Cl. .... D24/31; D6/396
- [58] Field of Search ..... D24/4, 5, 8, 10, 16, D24/31, 32; D9/341, 345, 347, 423, 424, 425, 426, 456; D3/74; 206/364-365, 366, 368-369, 570-572, 438, 63.5, 557-558, 562-564; 312/209; 433/77; D6/396

- D. 280,976 10/1985 Diamond ..... D9/345 X
- 4,153,160 5/1979 Leigh ..... 206/570 X
- 4,293,074 10/1981 Dunsky ..... 206/369 X

Primary Examiner—B. J. Bullock  
 Assistant Examiner—Brian N. Vinson  
 Attorney, Agent, or Firm—Charles J. Metz

[57] CLAIM

The ornamental design for a combined container and display case for dental bottles, as shown and described.

DESCRIPTION

FIG. 1 is a top perspective view of a combined container and display case for dental bottles showing my new design;  
 FIG. 2 is a right side elevational view thereof, the left side being identical in appearance;  
 FIG. 3 is a top plan view thereof;  
 FIG. 4 is a front elevational view thereof;  
 FIG. 5 is a rear elevational view thereof;  
 FIG. 6 is a bottom plan view thereof; and  
 FIG. 7 is an exploded top perspective view thereof, with the broken-line showing of dental bottles placed in the container being for illustrative purposes only and forming no part of the claimed design.

- [56] References Cited
- U.S. PATENT DOCUMENTS
- D. 249,241 9/1978 Halleron ..... D9/424
- D. 269,791 7/1983 Chatham ..... D9/347 X

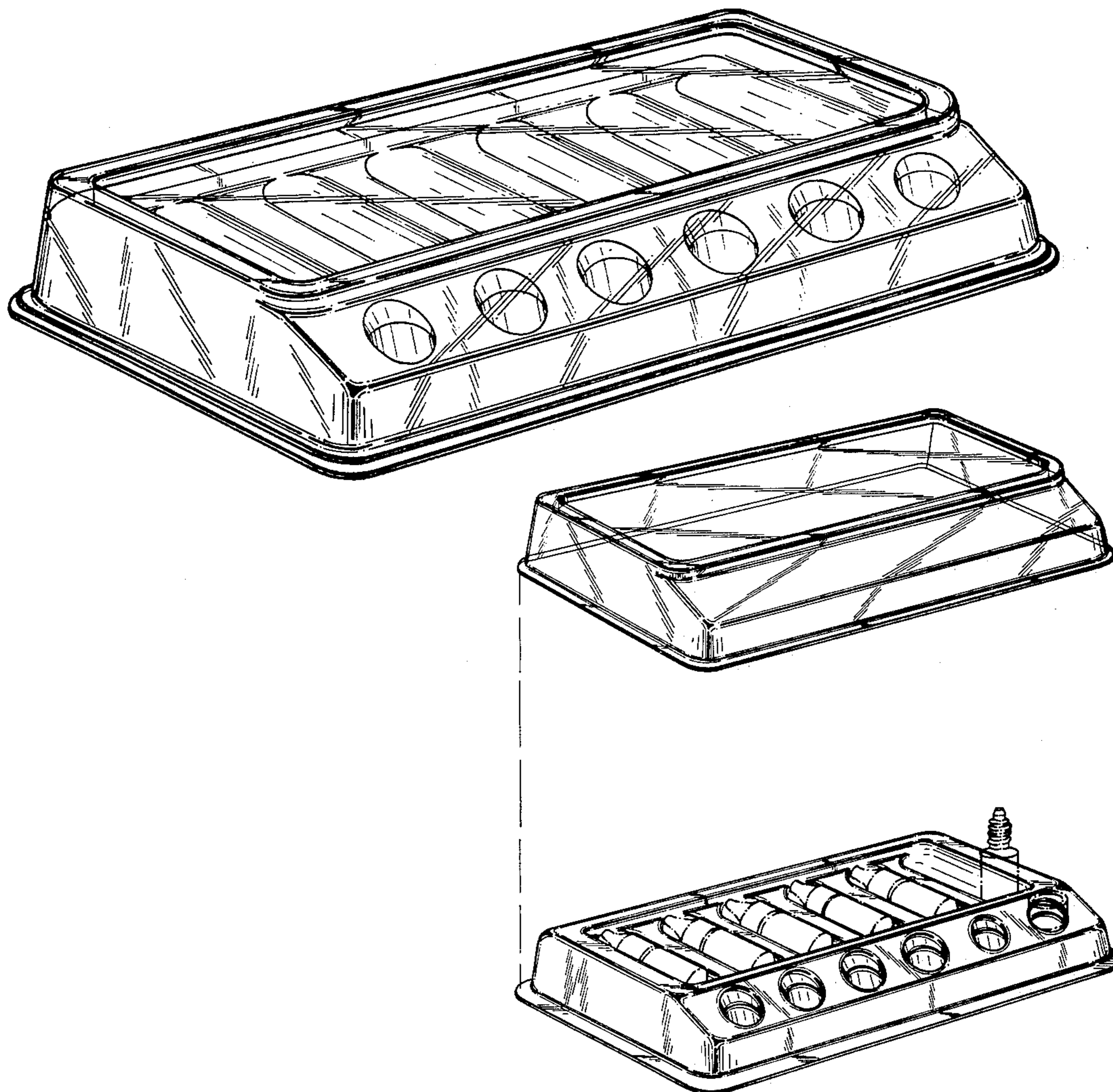

FIG-1

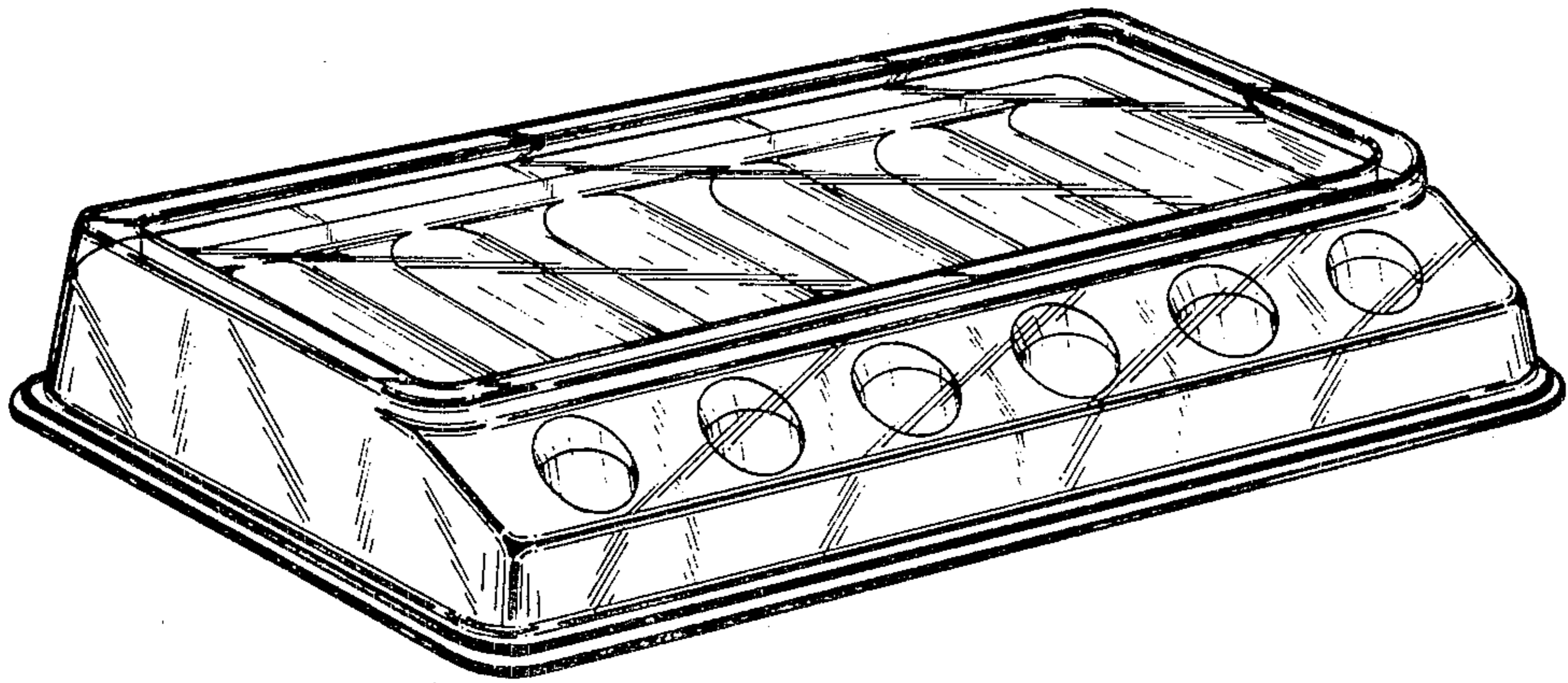
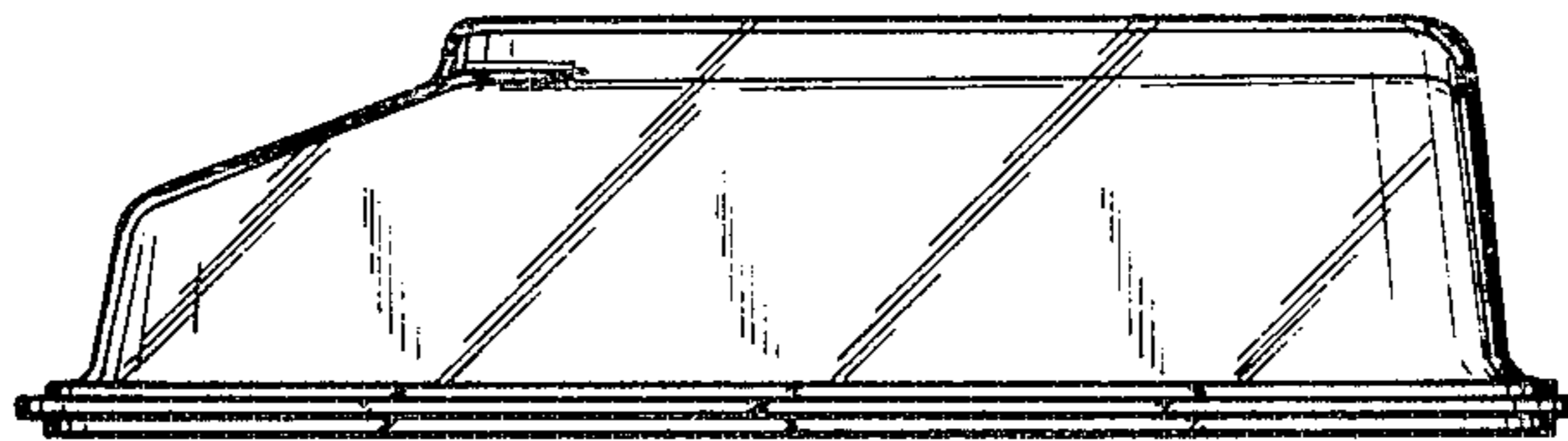

FIG-2



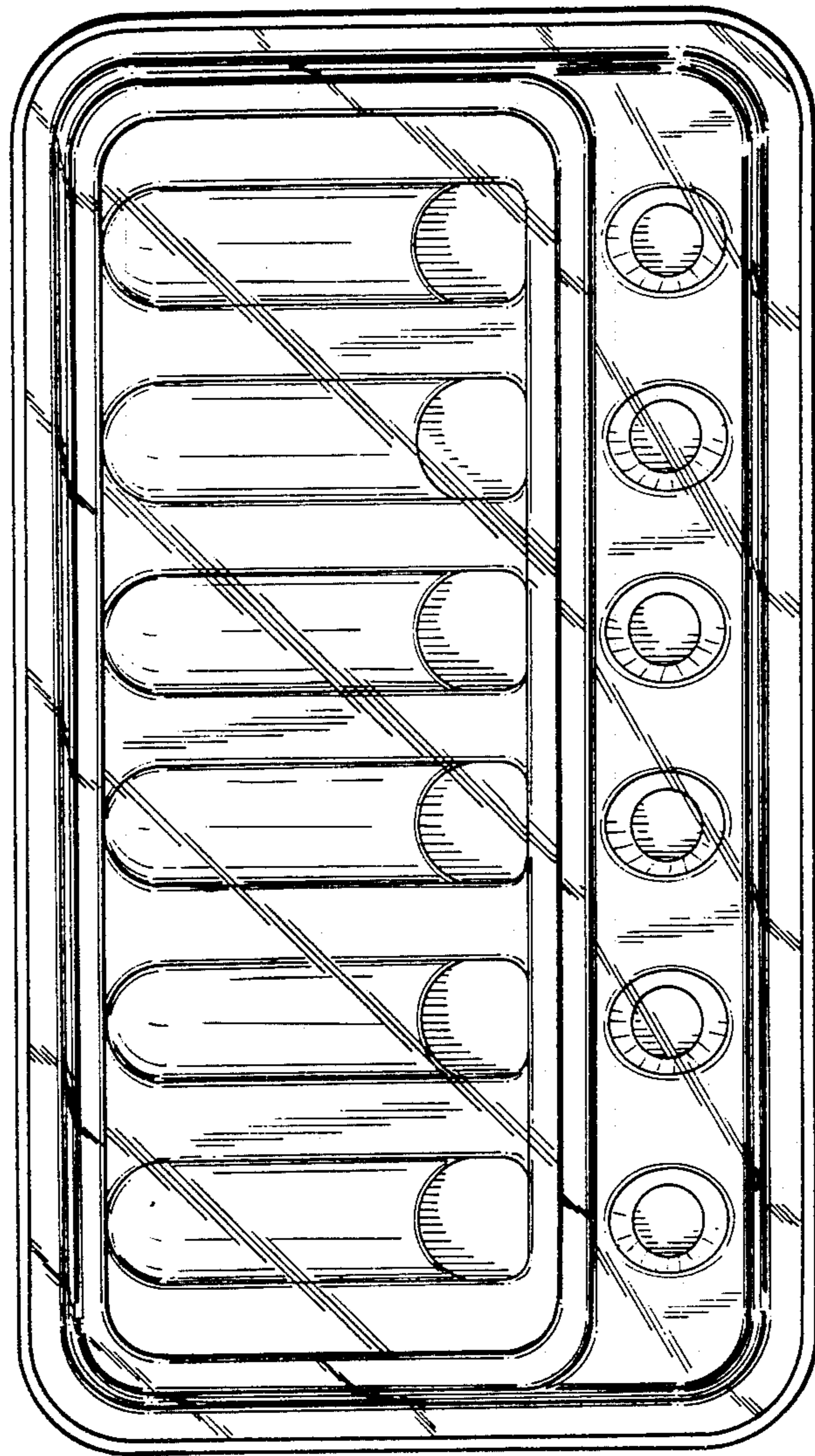

FIG-3

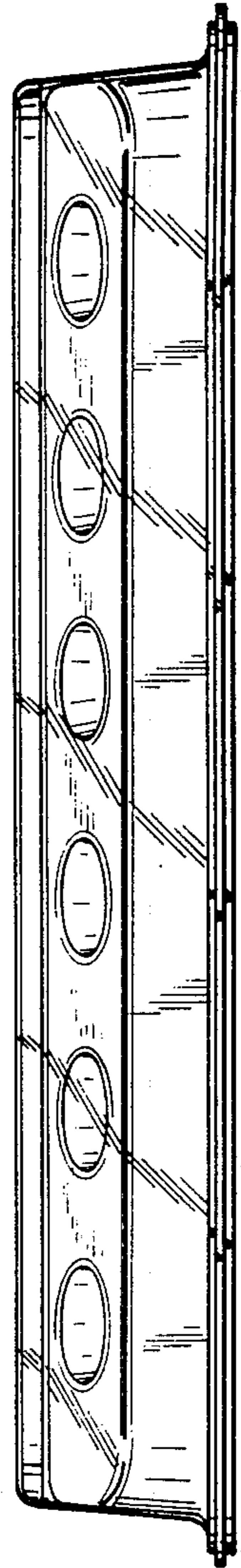

FIG-4

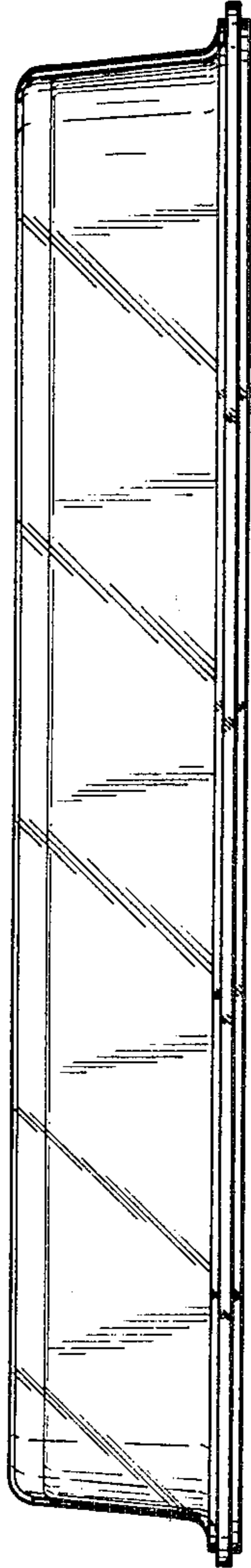

FIG-5

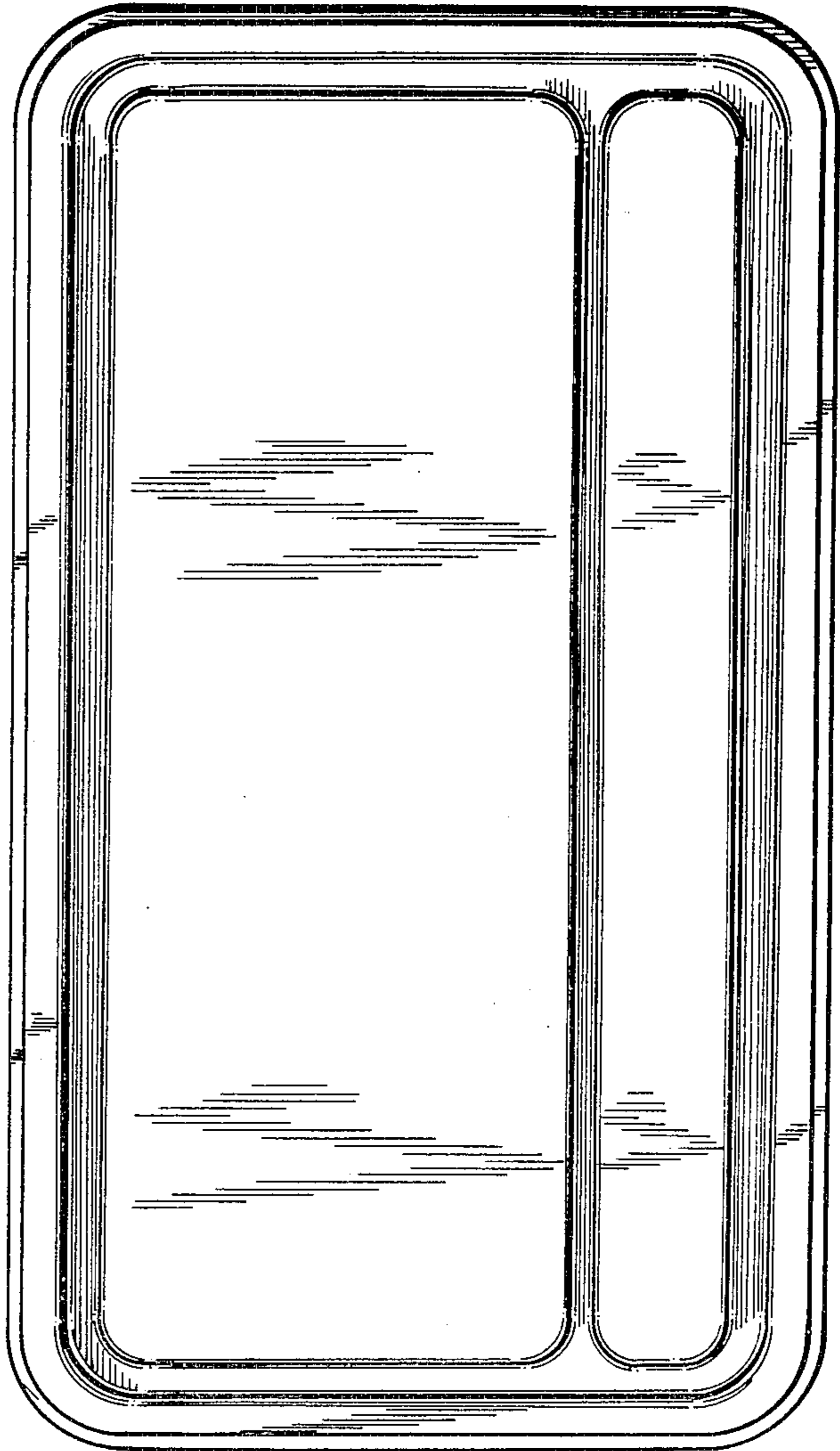

FIG-6

FIG-7

