

[54] RECONFIGURABLE TOY WATCH

[75] Inventor: Iwakichi Ogawa, Kashiwa, Japan

[73] Assignee: Takara Co., Ltd., Tokyo, Japan

[\*\*] Term: 14 Years

[21] Appl. No.: 641,511

[22] Filed: Aug. 16, 1984

[52] U.S. Cl. .... D21/144; D21/136; D21/150; D21/166

[58] Field of Search ..... D21/144, 136, 128, 150, D21/166; D10/32, 33, 38, 39; D12/82, 86; 446/71-73, 76-77, 487

[56] References Cited

U.S. PATENT DOCUMENTS

D. 237,383	10/1975	Freeman	.....	D21/166
D. 261,532	10/1981	Tabata	.....	D19/64
D. 275,586	9/1984	Matsuda	.....	D21/144
D. 284,453	7/1986	Nakane	.....	D10/33
D. 284,948	8/1986	Ogawa	.....	D21/150
D. 285,417	9/1986	Nakane	.....	D21/150
4,456,384	6/1984	Murakami	.....	446/487

Primary Examiner—Charles A. Rademaker  
Attorney, Agent, or Firm—Price, Gess & Ubell

[57] CLAIM

The ornamental design for a reconfigurable toy watch, substantially as shown and described.

DESCRIPTION

FIG. 1 is a front perspective view of a reconfigurable toy watch showing my new design;  
 FIG. 2 is a front elevational view thereof;  
 FIG. 3 is a right elevational side view thereof, the side opposite being a mirror image;  
 FIG. 4 is a rear elevational view thereof;  
 FIG. 5 is a top plan view thereof;  
 FIG. 6 is a bottom plan view thereof;  
 FIG. 7 is a perspective view of the strap member with the watch assembly removed;  
 FIG. 8 is a front side perspective view thereof;  
 FIG. 9 is a front elevational view thereof;  
 FIG. 10 is a right elevational side view thereof, the side opposite being a mirror image;  
 FIG. 11 is a rear elevational view thereof;  
 FIG. 12 is a top plan view thereof;  
 FIG. 13 is a bottom plan view thereof;  
 FIG. 14 is a front side perspective view of the watch assembly showing portions thereof in the first alternate position;  
 FIG. 15 is a front elevational view thereof;  
 FIG. 16 is a right elevational side view thereof, the side opposite being a mirror image;  
 FIG. 17 is a rear elevational view thereof;  
 FIG. 18 is a top plan view thereof;  
 FIG. 19 is a bottom plan view thereof;  
 FIG. 20 is another front side perspective view of the watch assembly showing portions thereof in the second alternate position;  
 FIG. 21 is a front elevational view thereof;  
 FIG. 22 is a right elevational side view thereof, the side opposite being a mirror image;  
 FIG. 23 is a rear elevational view thereof;  
 FIG. 24 is a top plan view thereof; and  
 FIG. 25 is a bottom plan view thereof.

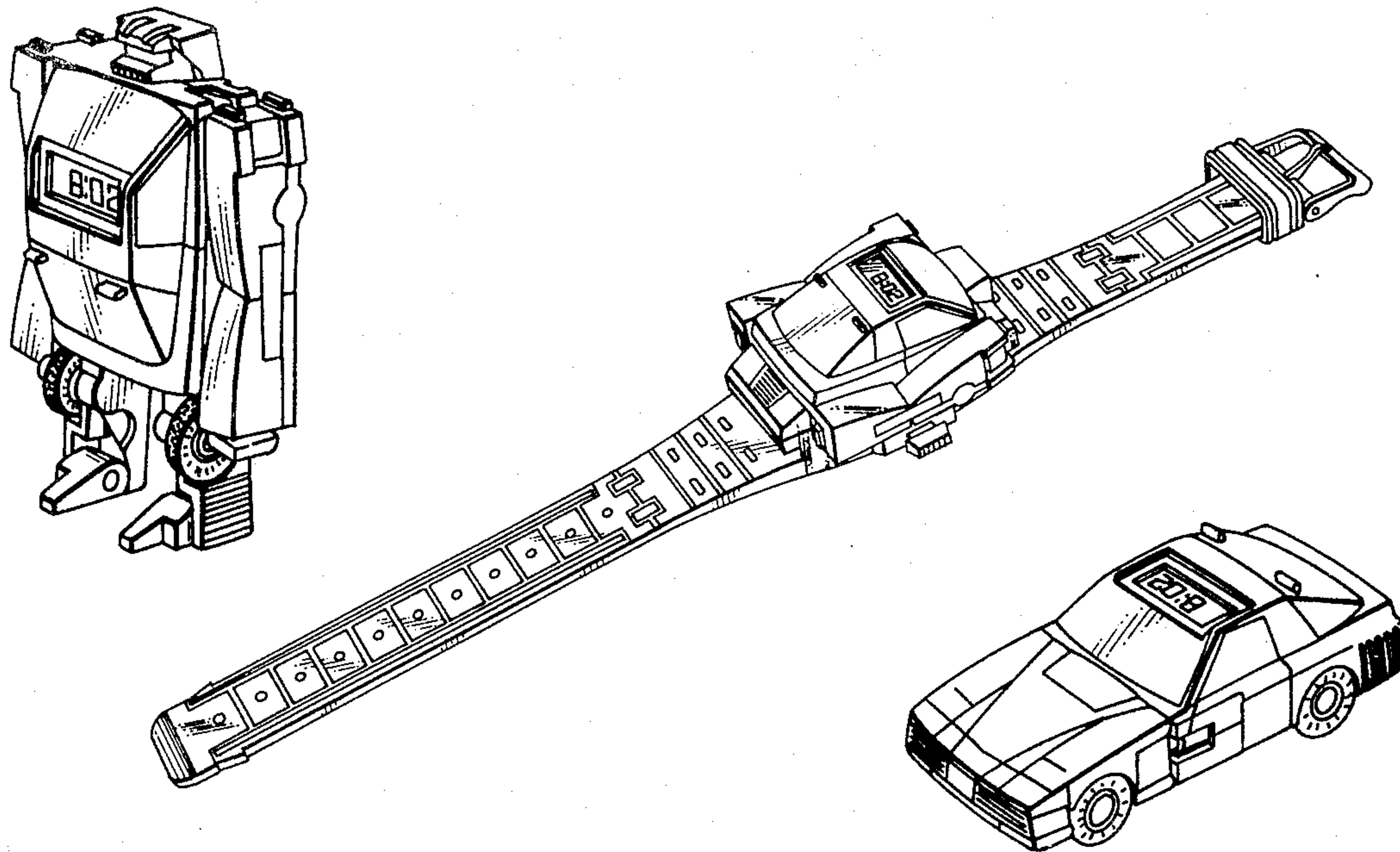

FIG. 1

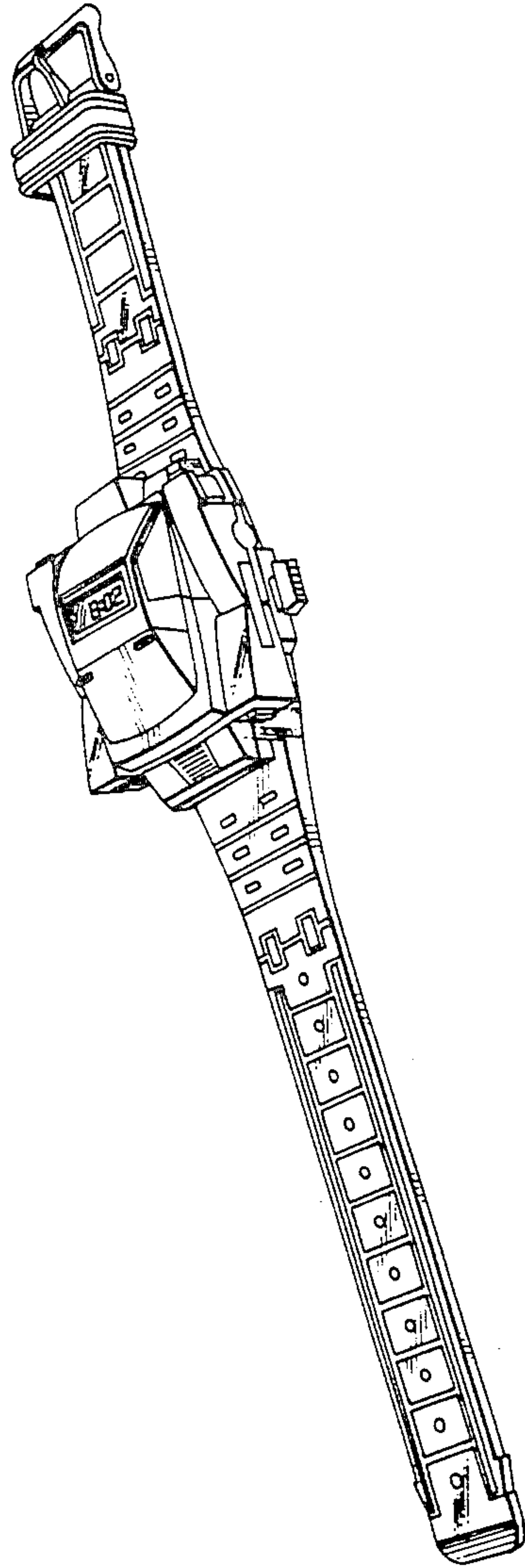

FIG. 2

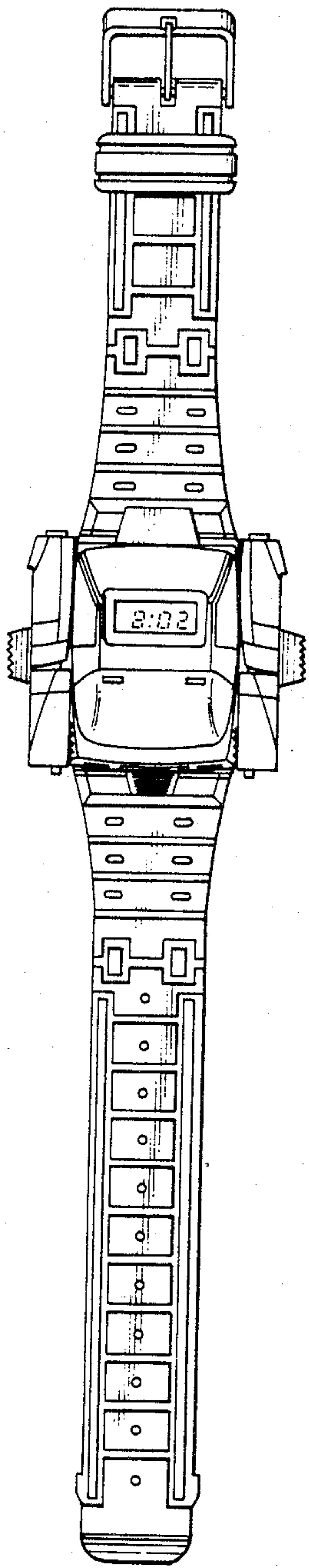

FIG. 3

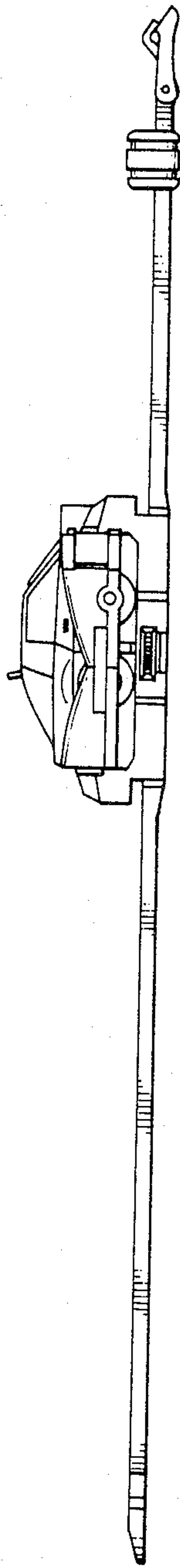

FIG. 4

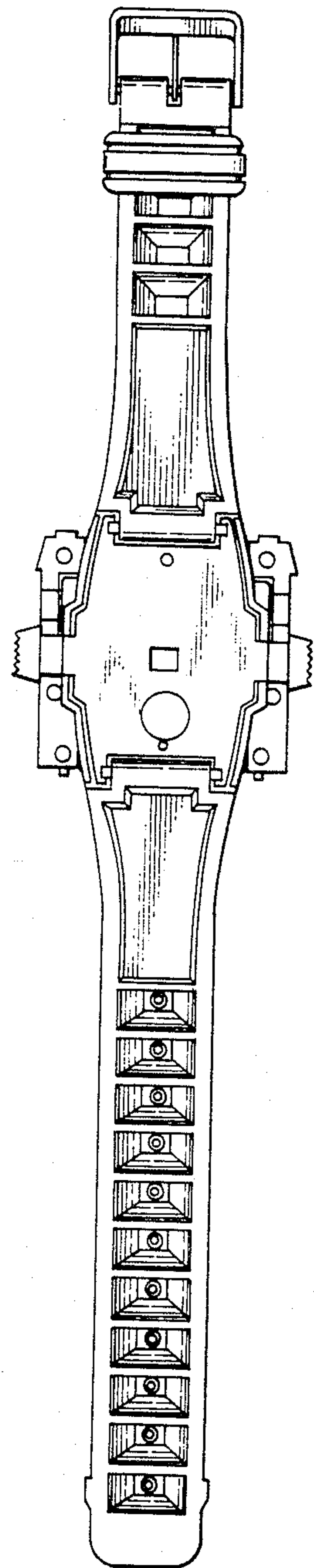



FIG. 5

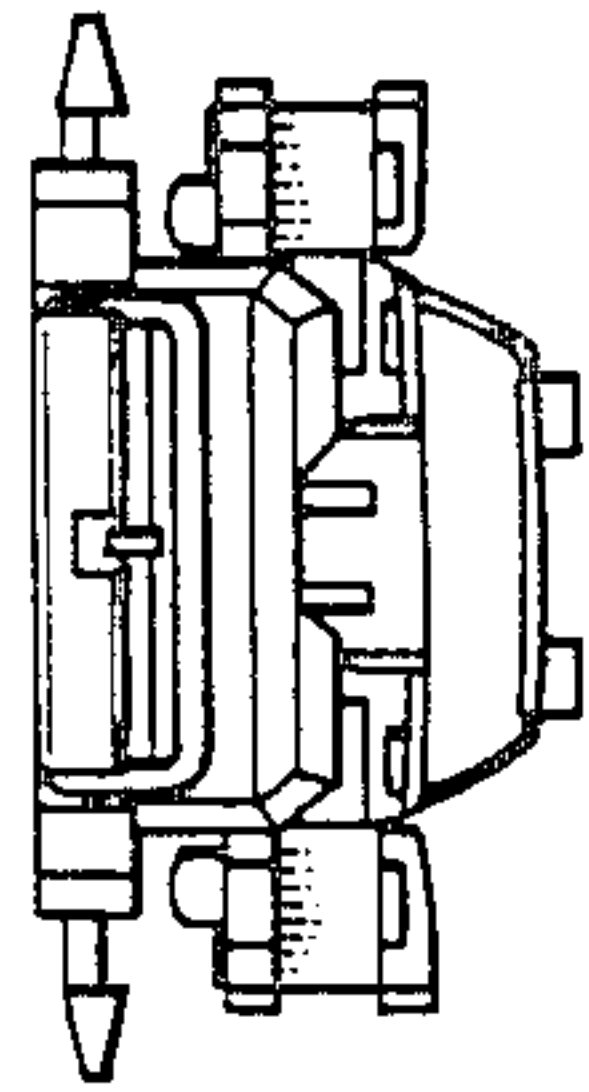

FIG. 6

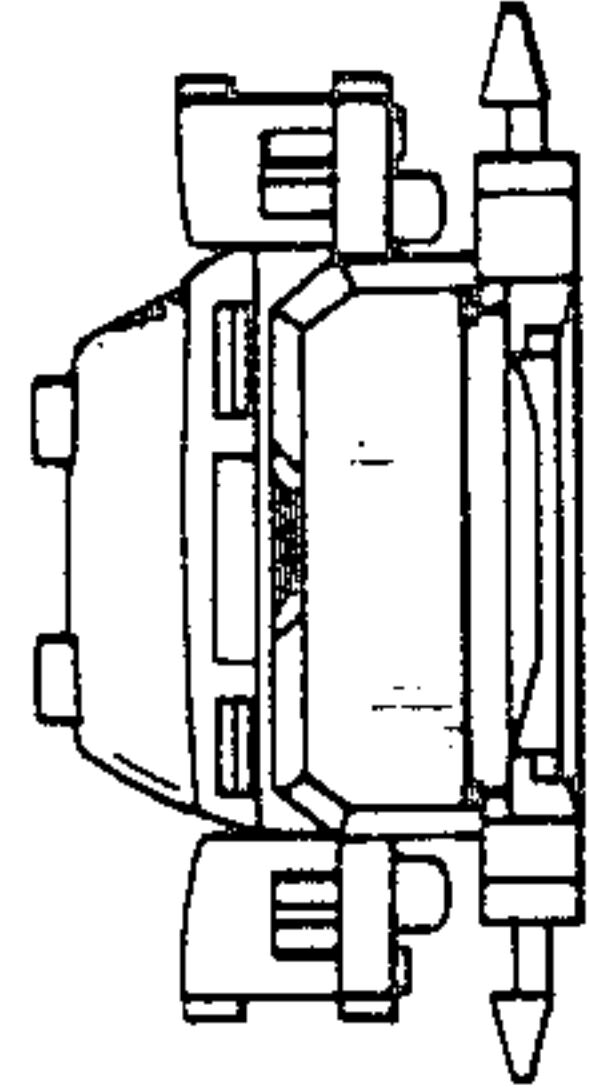

FIG. 7

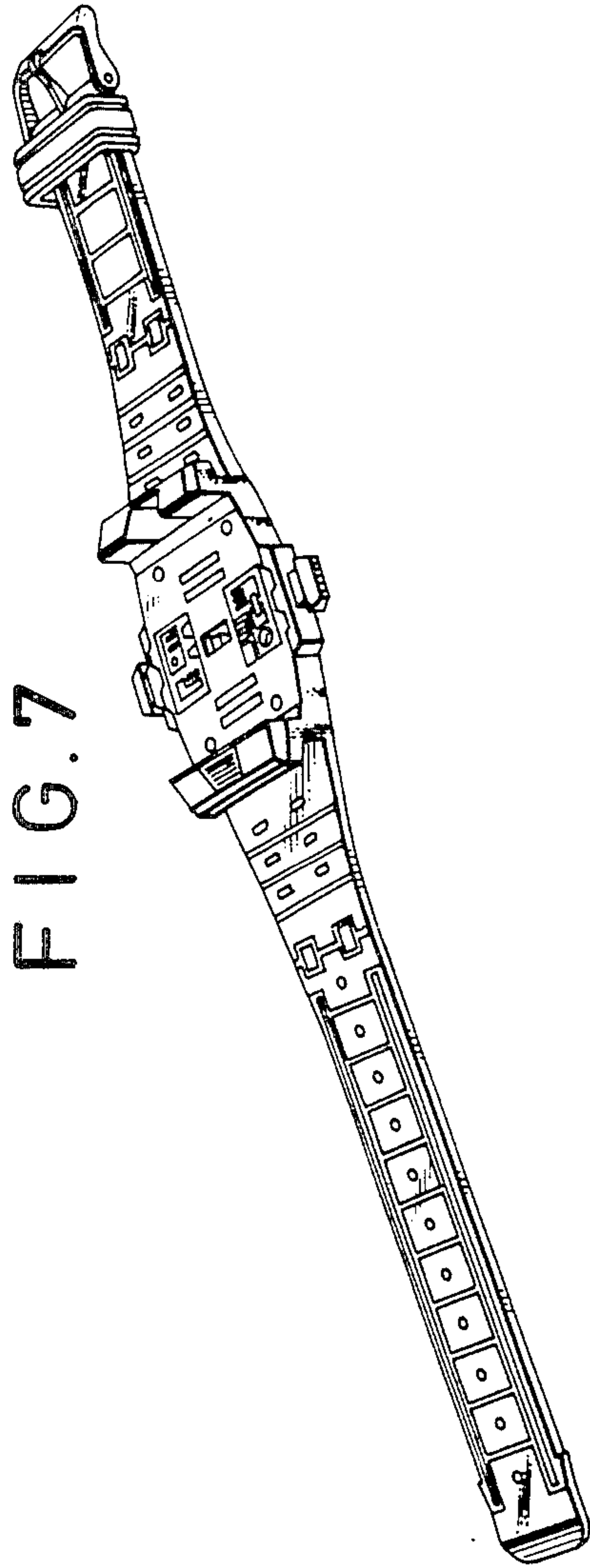

FIG. 8

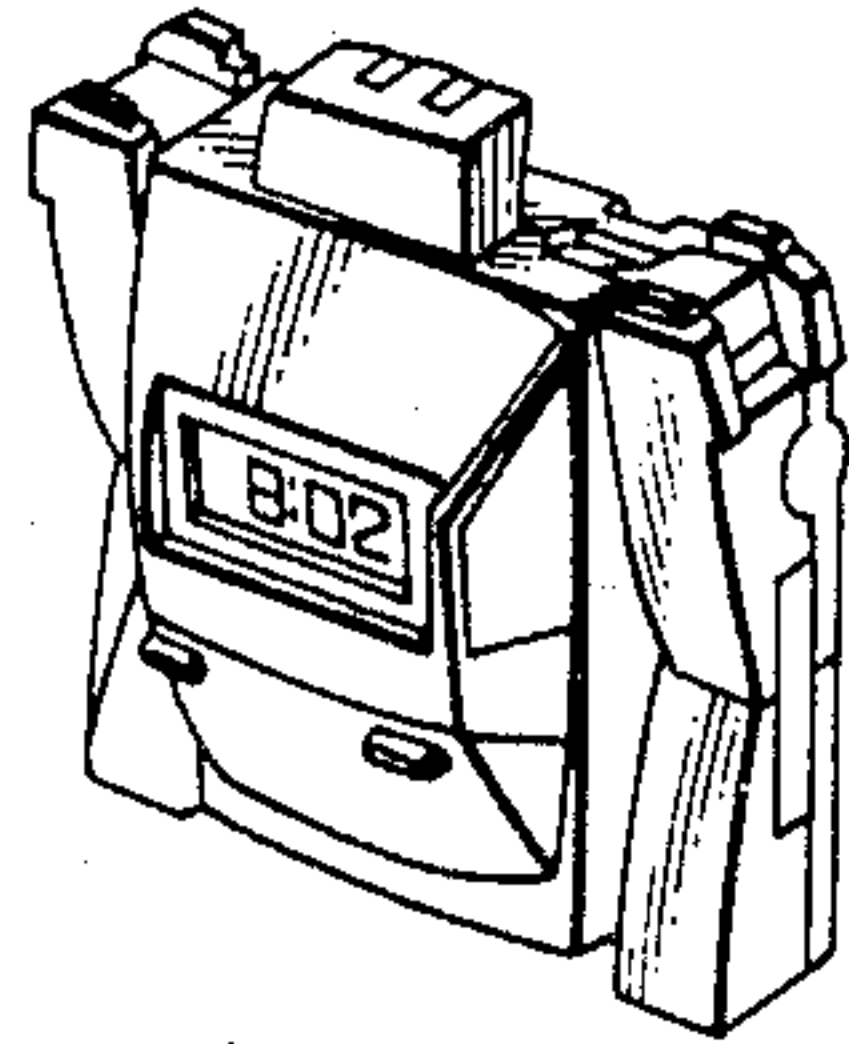

FIG. 9

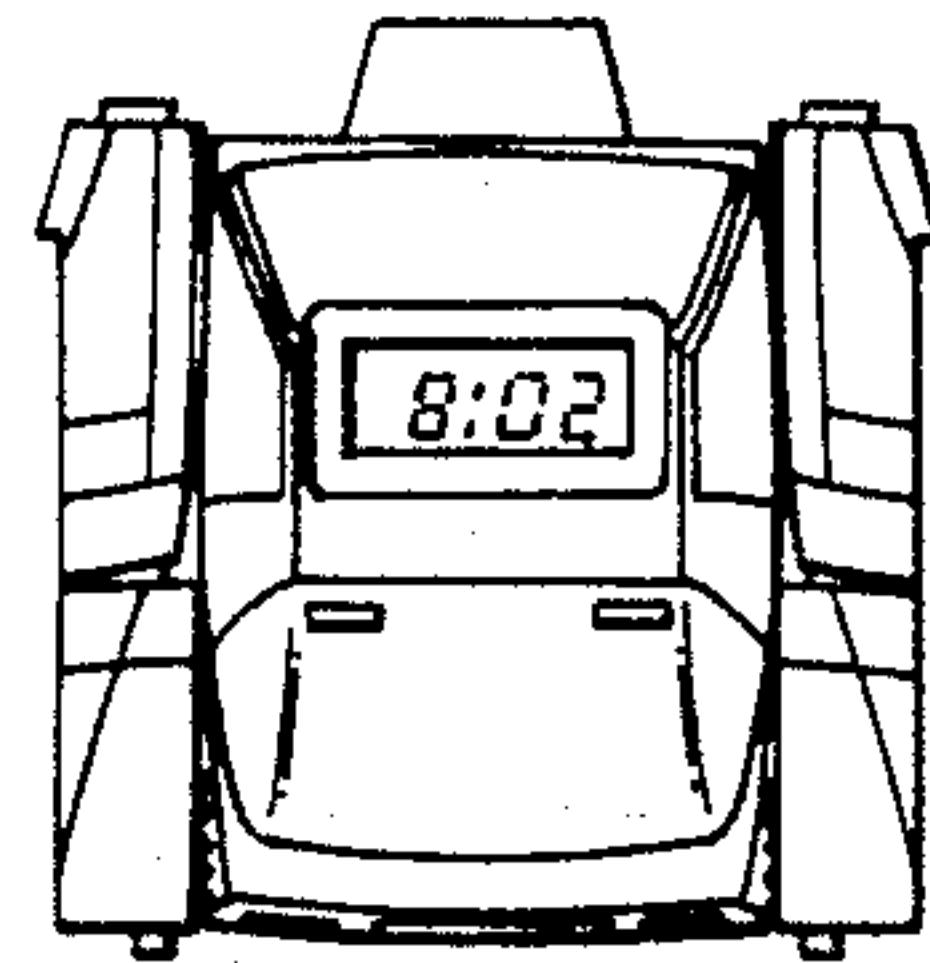

FIG. 10

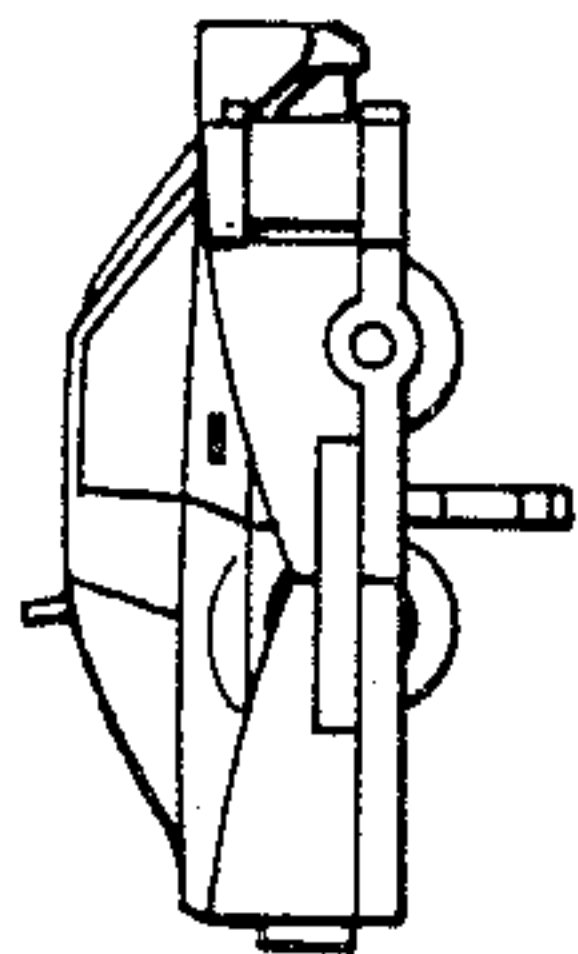

FIG. 11

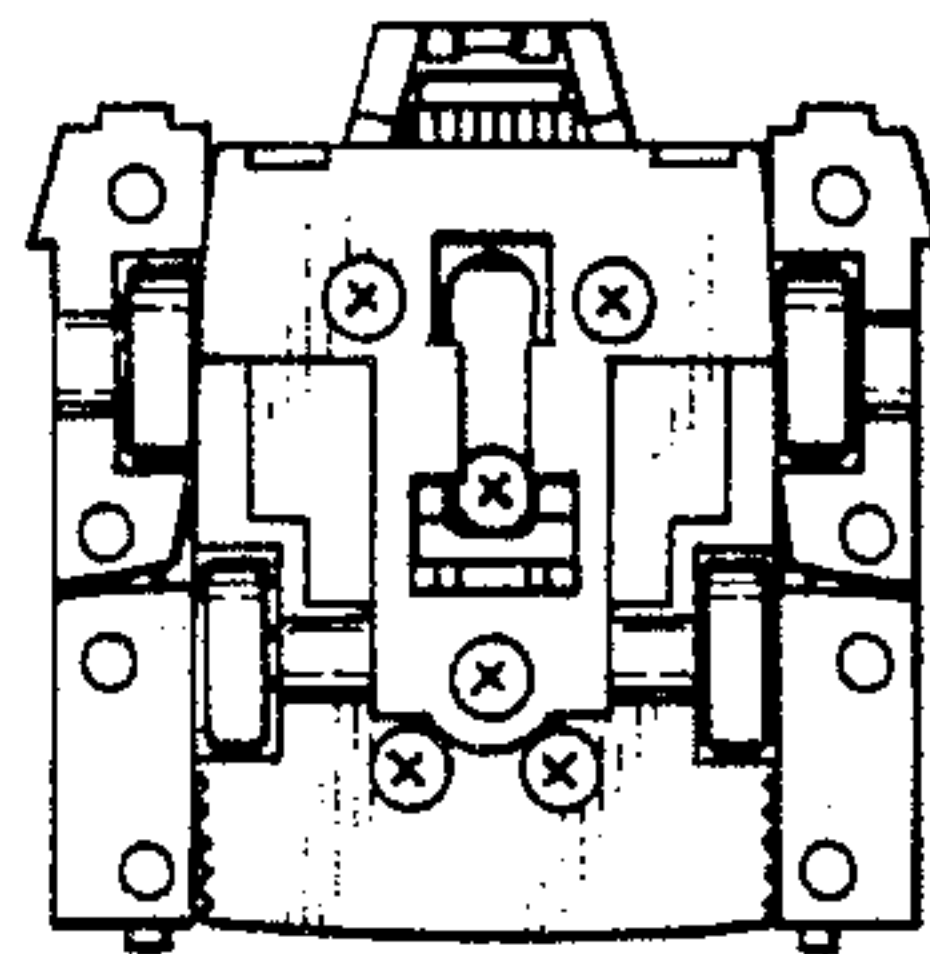

FIG. 12

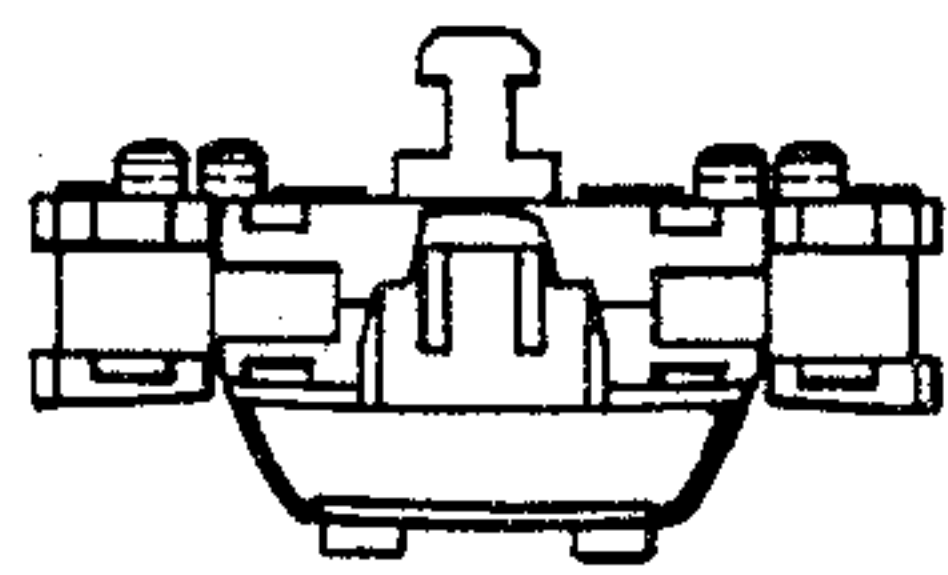

FIG. 13

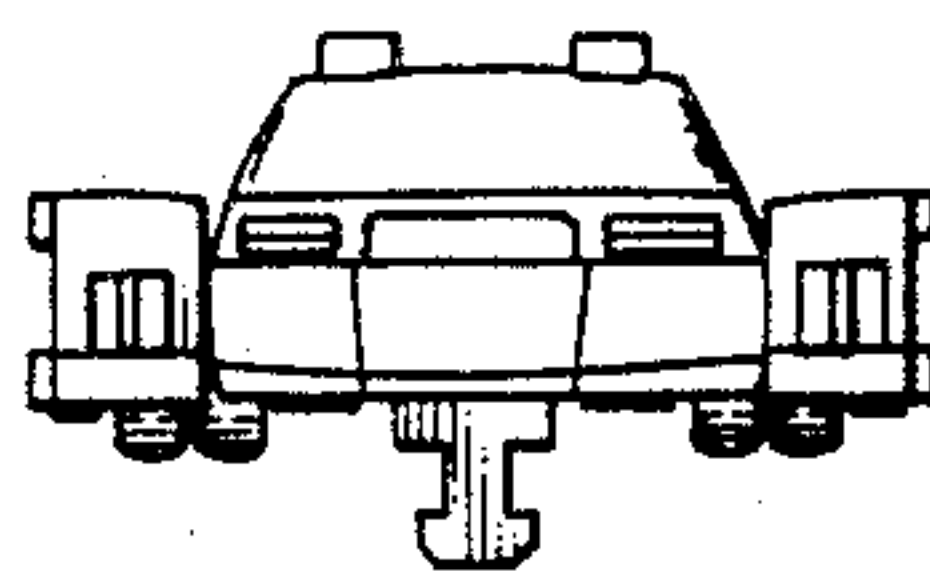

FIG. 14

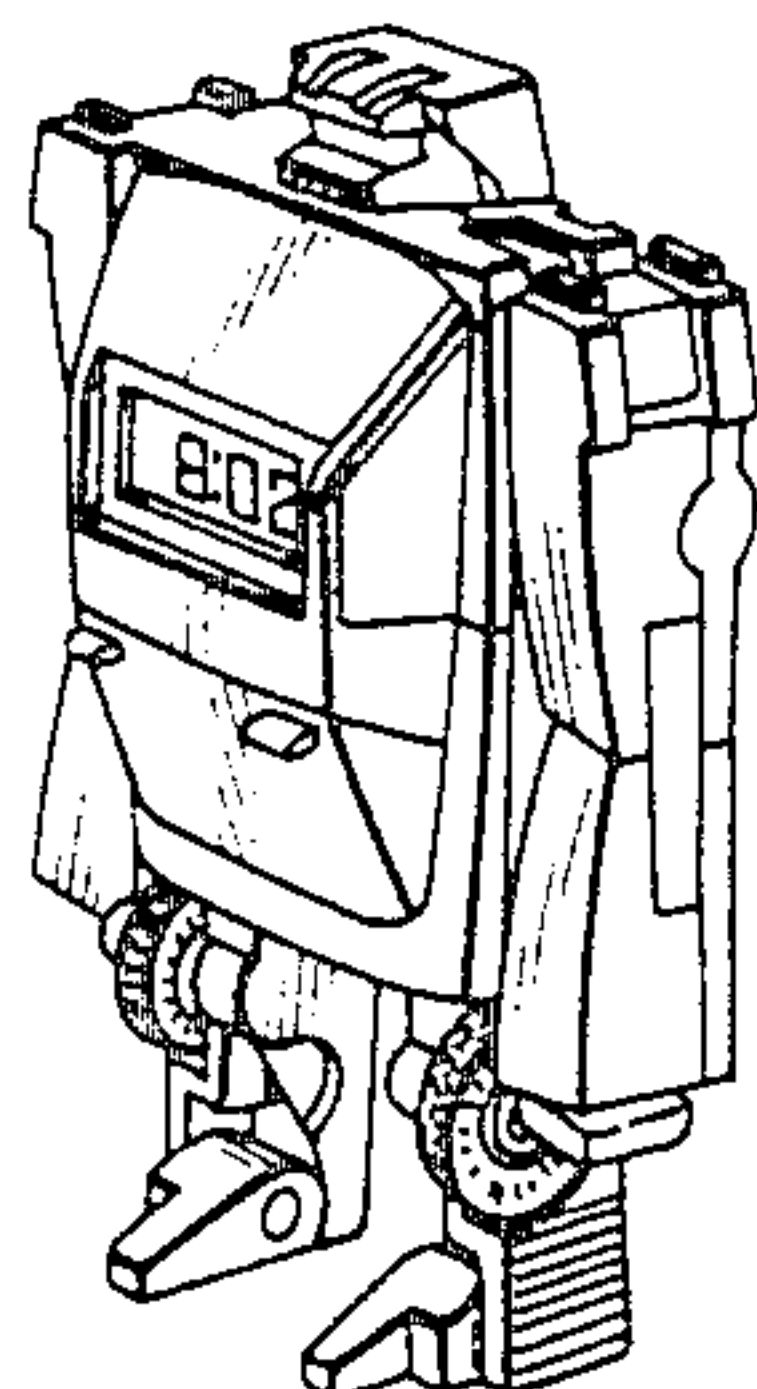

FIG. 15

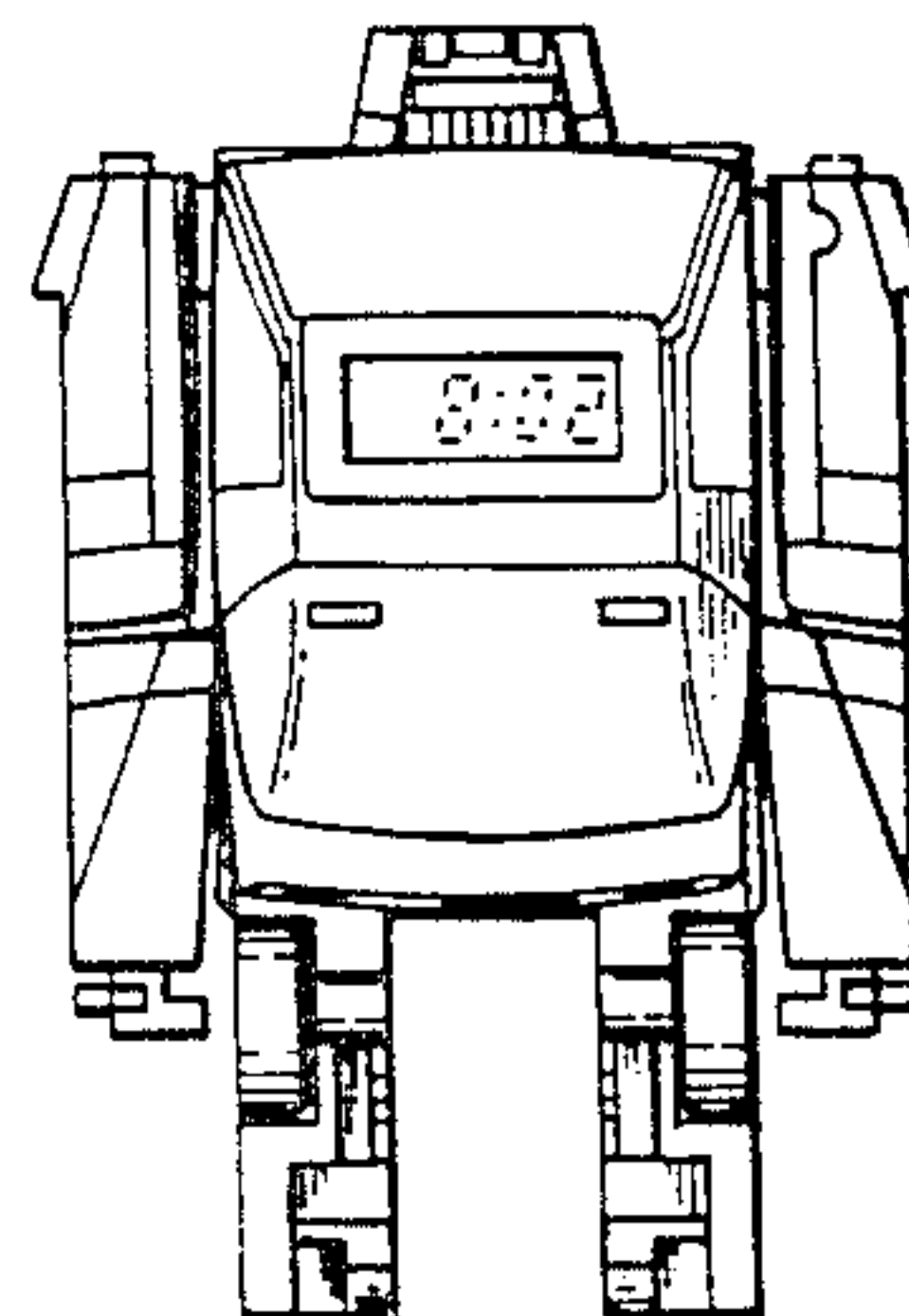

FIG. 16

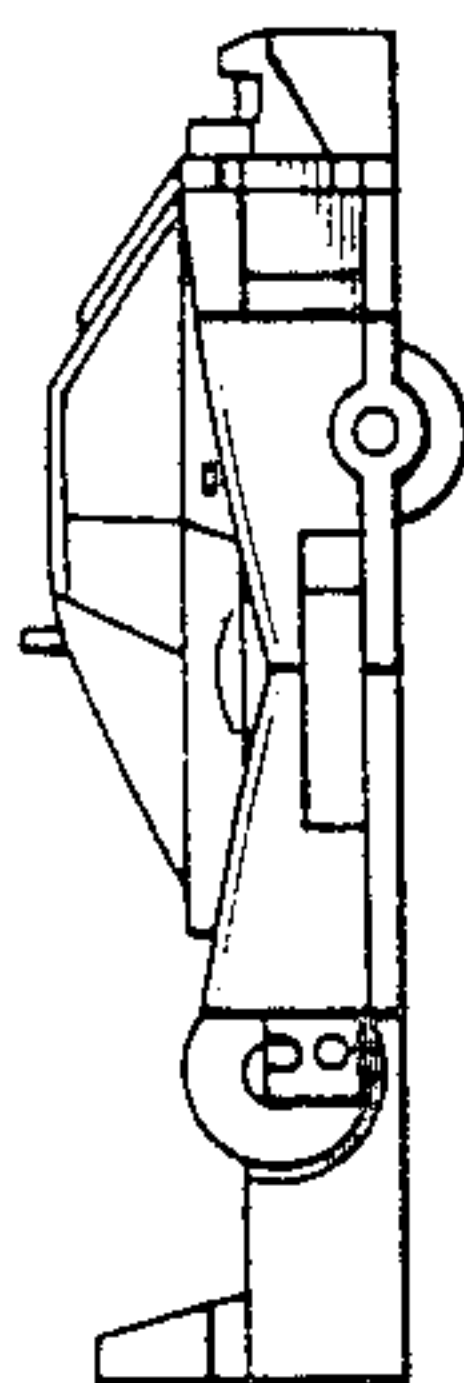

FIG. 17

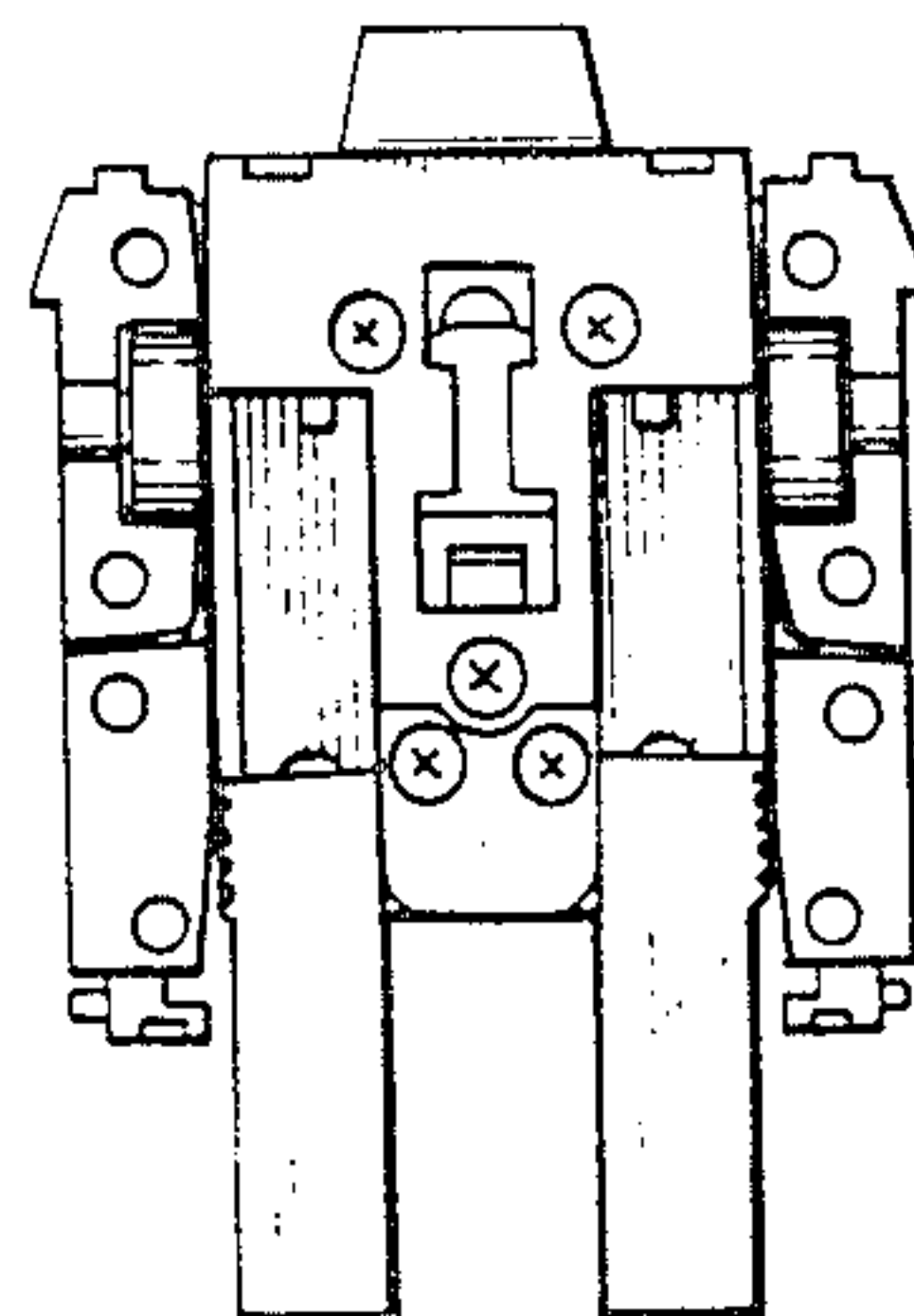

FIG. 18

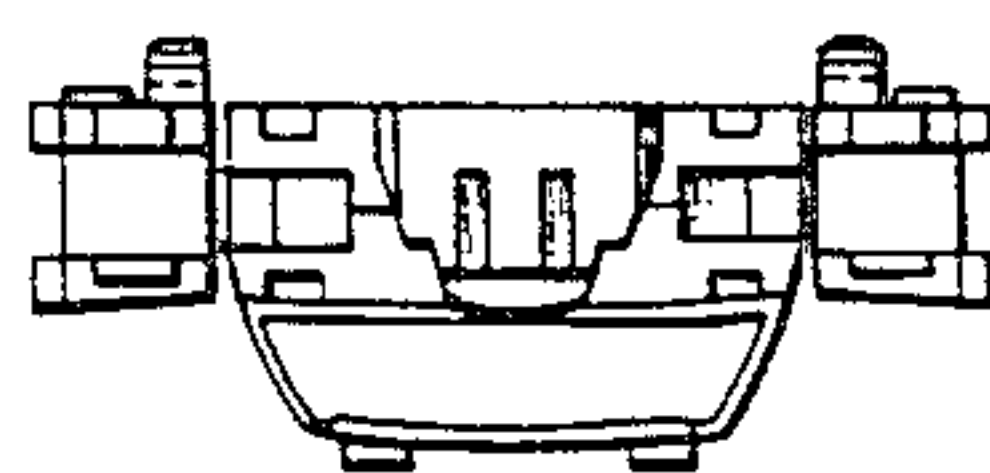

FIG. 19

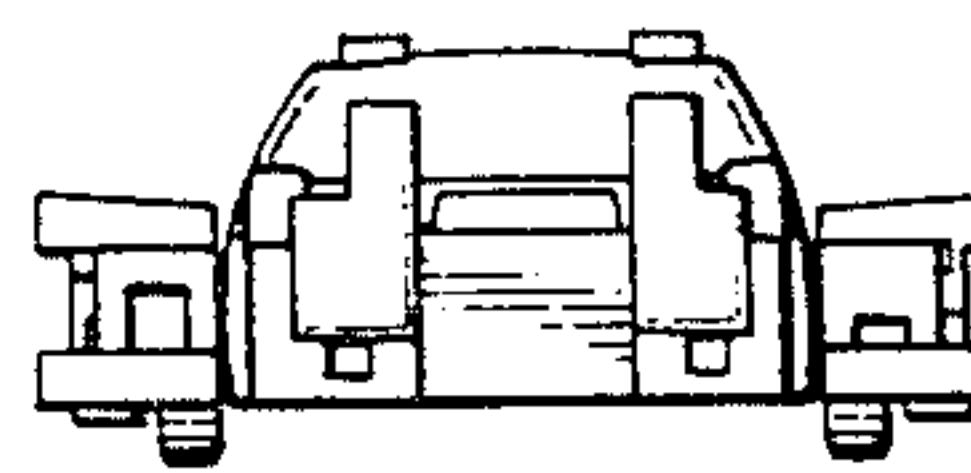

FIG. 20

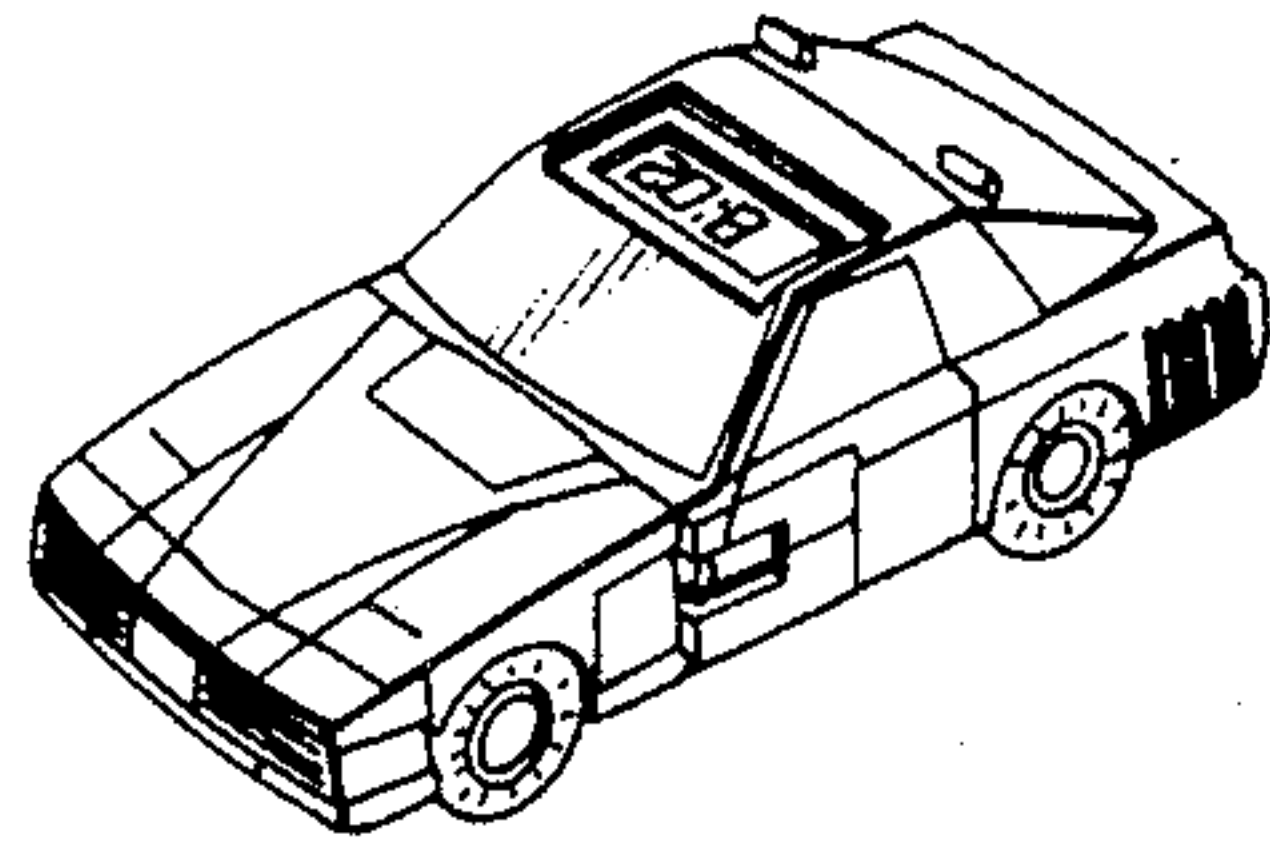

FIG. 21

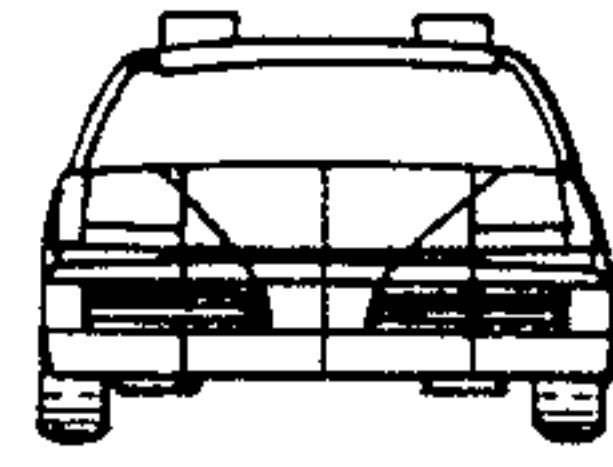

FIG. 22

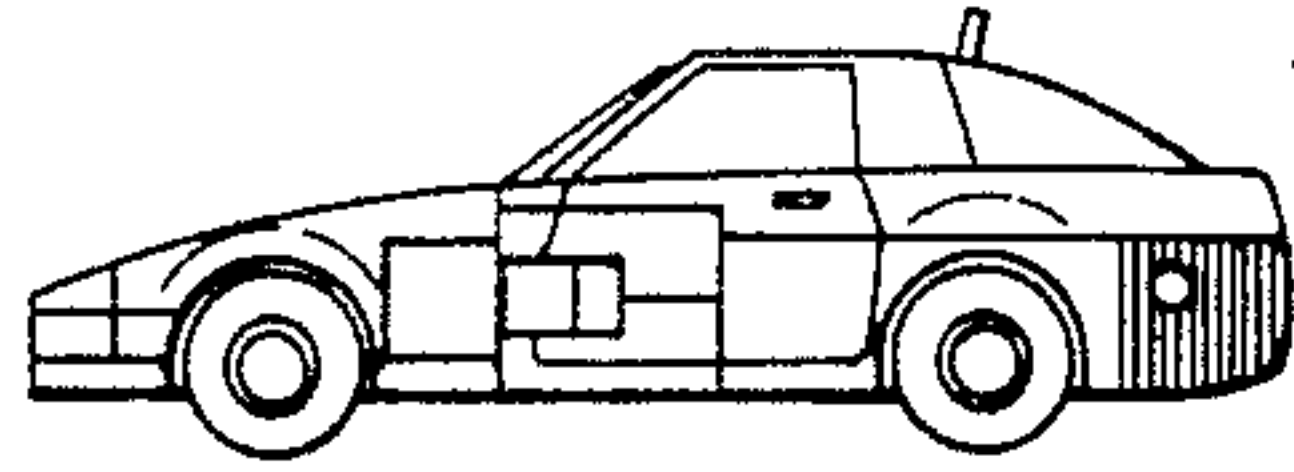

FIG. 23

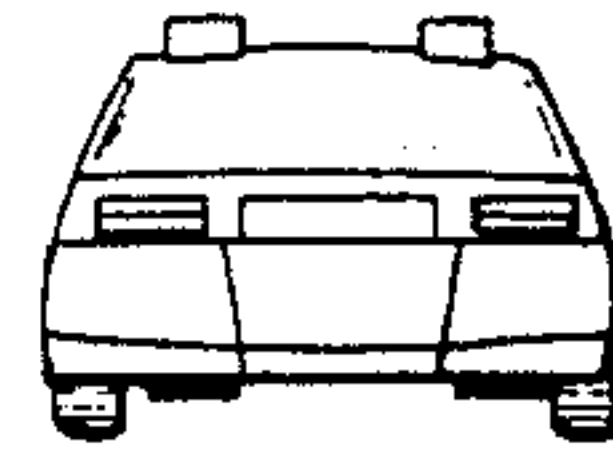

FIG. 24

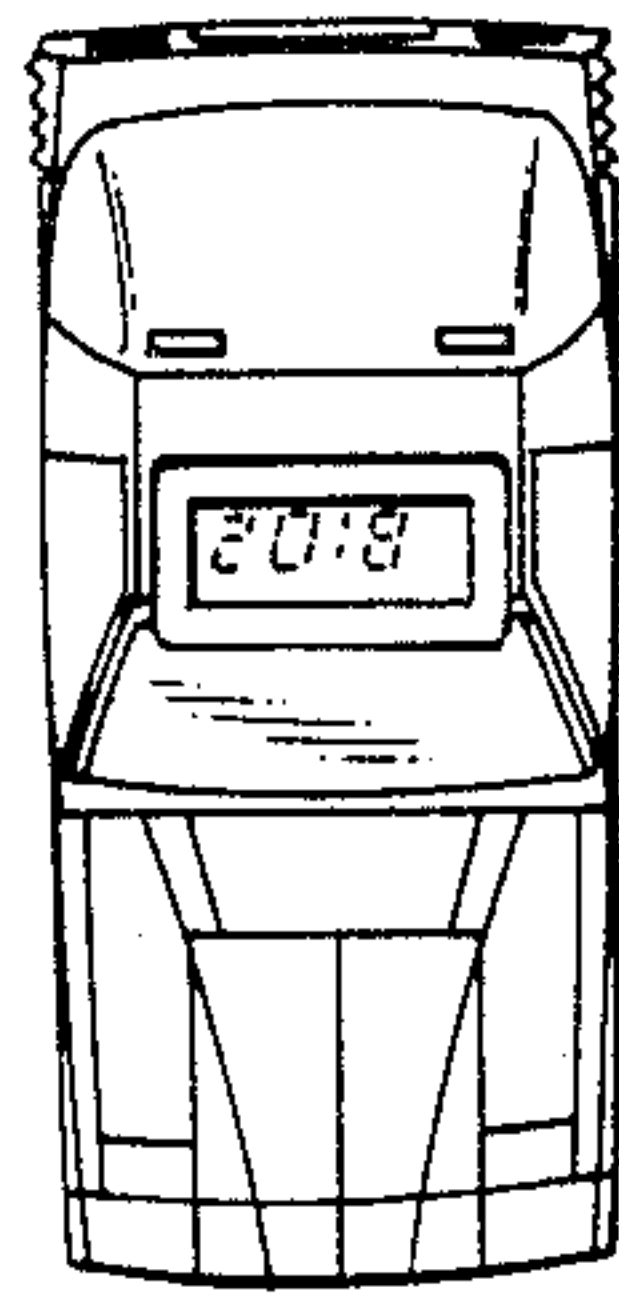

FIG. 25

