

[54] TAPE MEASURE

[76] Inventor: Eui C. Kang, 575 Janglim-Dong, Suh-ku, Busan, Rep. of Korea

[\*\*] Term: 14 Years

[21] Appl. No.: 609,341

[22] Filed: May 11, 1984

[52] U.S. Cl. .... D10/72

[58] Field of Search ..... D10/71, 72; 33/137 R, 33/138; 242/84.8, 107

[56] References Cited

U.S. PATENT DOCUMENTS

D. 228,149	8/1973	Bennett	.....	D10/72
3,494,038	2/1970	Quenot	.....	33/138
3,812,588	5/1974	Bennett	.....	33/138
4,205,448	6/1980	Asai	.....	33/138

FOREIGN PATENT DOCUMENTS

2114094 8/1983 United Kingdom ..... 33/137 R

Primary Examiner—Nelson C. Holtje  
Attorney, Agent, or Firm—Birch, Stewart, Kolasch & Birch

[57] CLAIM

The ornamental design for a tape measure, as shown.

DESCRIPTION

FIG. 1 is a left front perspective view of a tape measure showing my new design;  
FIG. 2 is a left side elevational view thereof;  
FIG. 3 is a front elevational view thereof;  
FIG. 4 is a top plan view thereof;  
FIG. 5 is a right side elevational view thereof;  
FIG. 6 is a rear elevational view thereof; and  
FIG. 7 is a bottom plan view thereof.

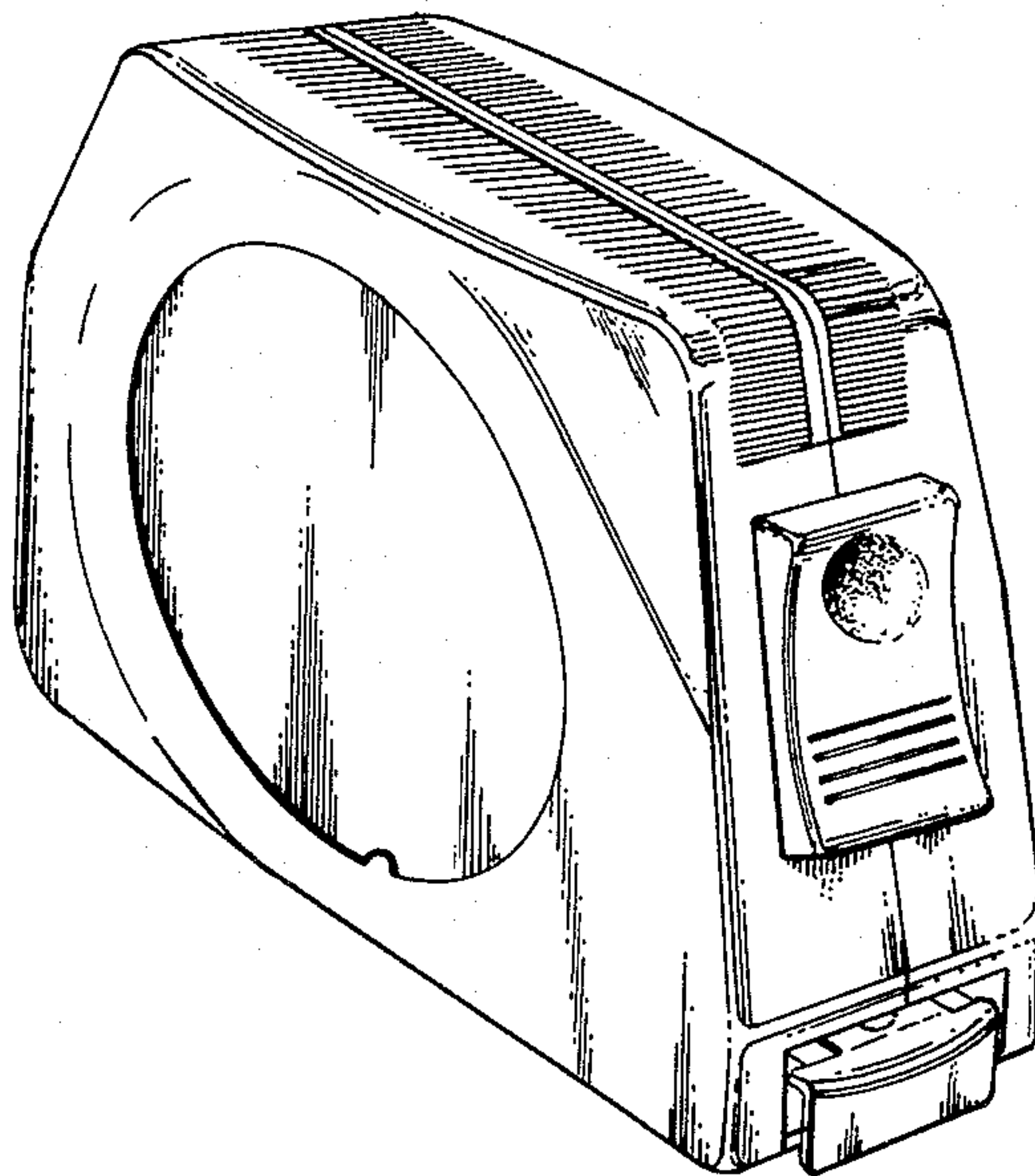

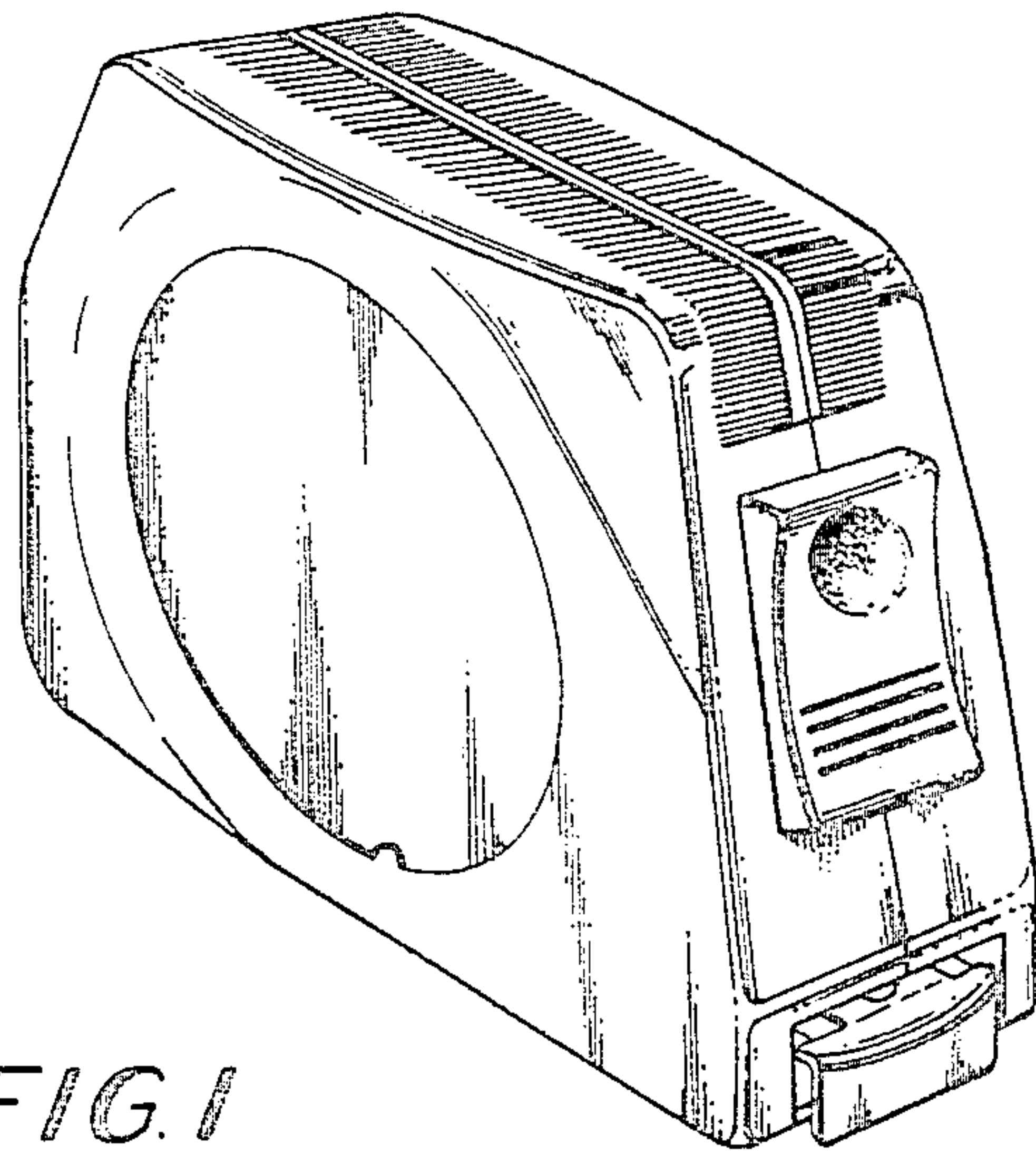

FIG. 1

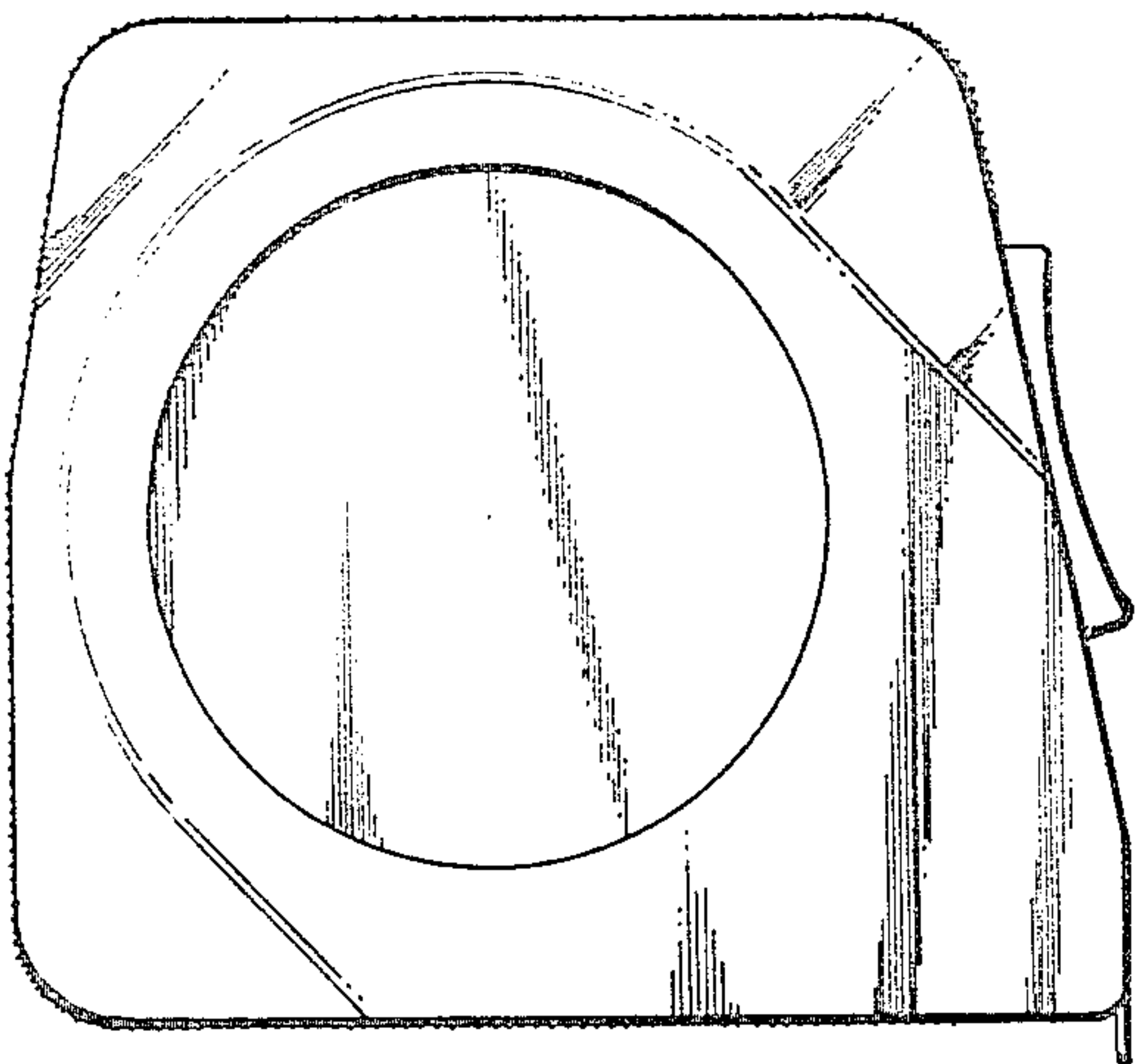

FIG. 2

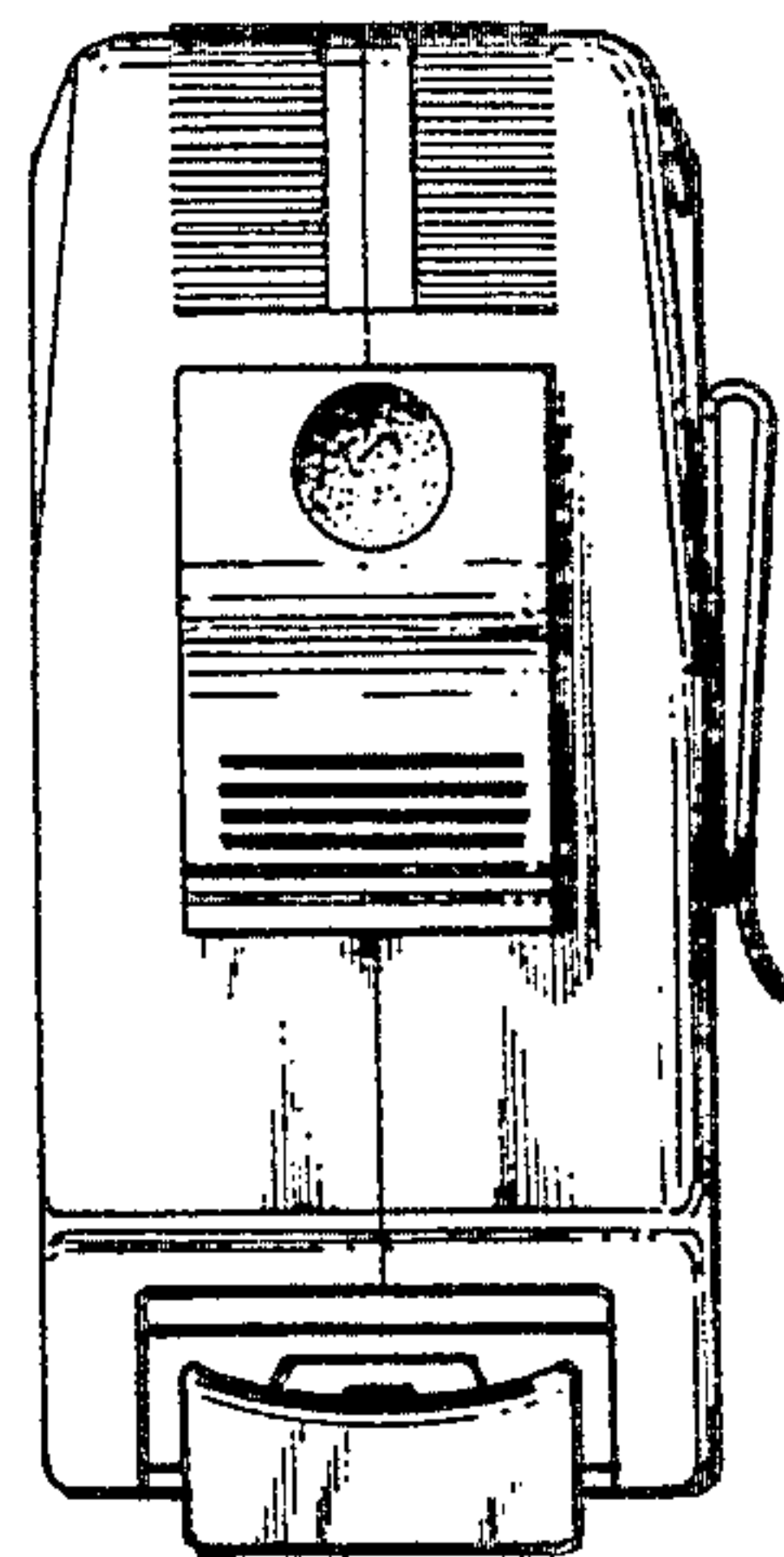

FIG. 3

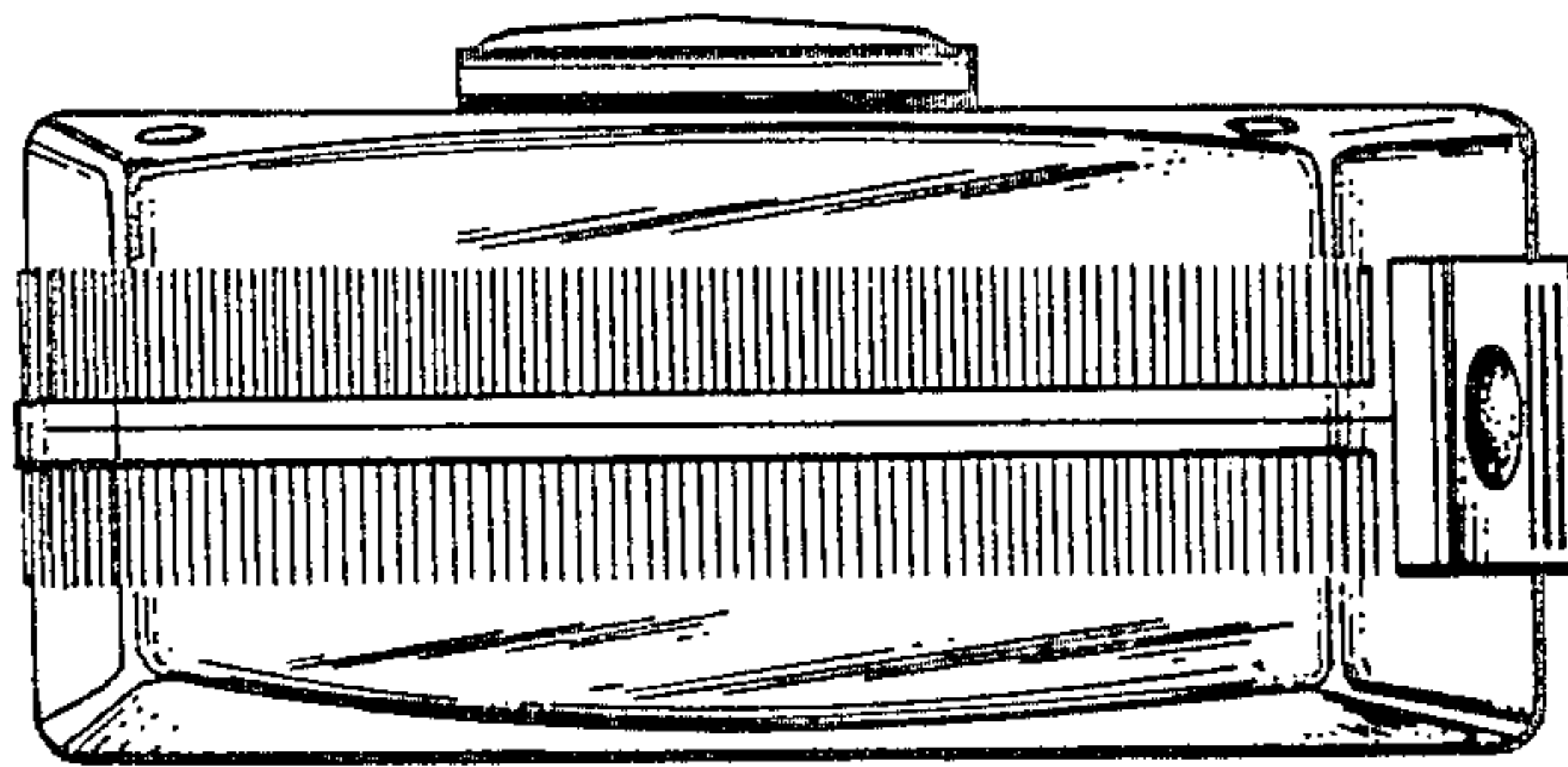

FIG. 4

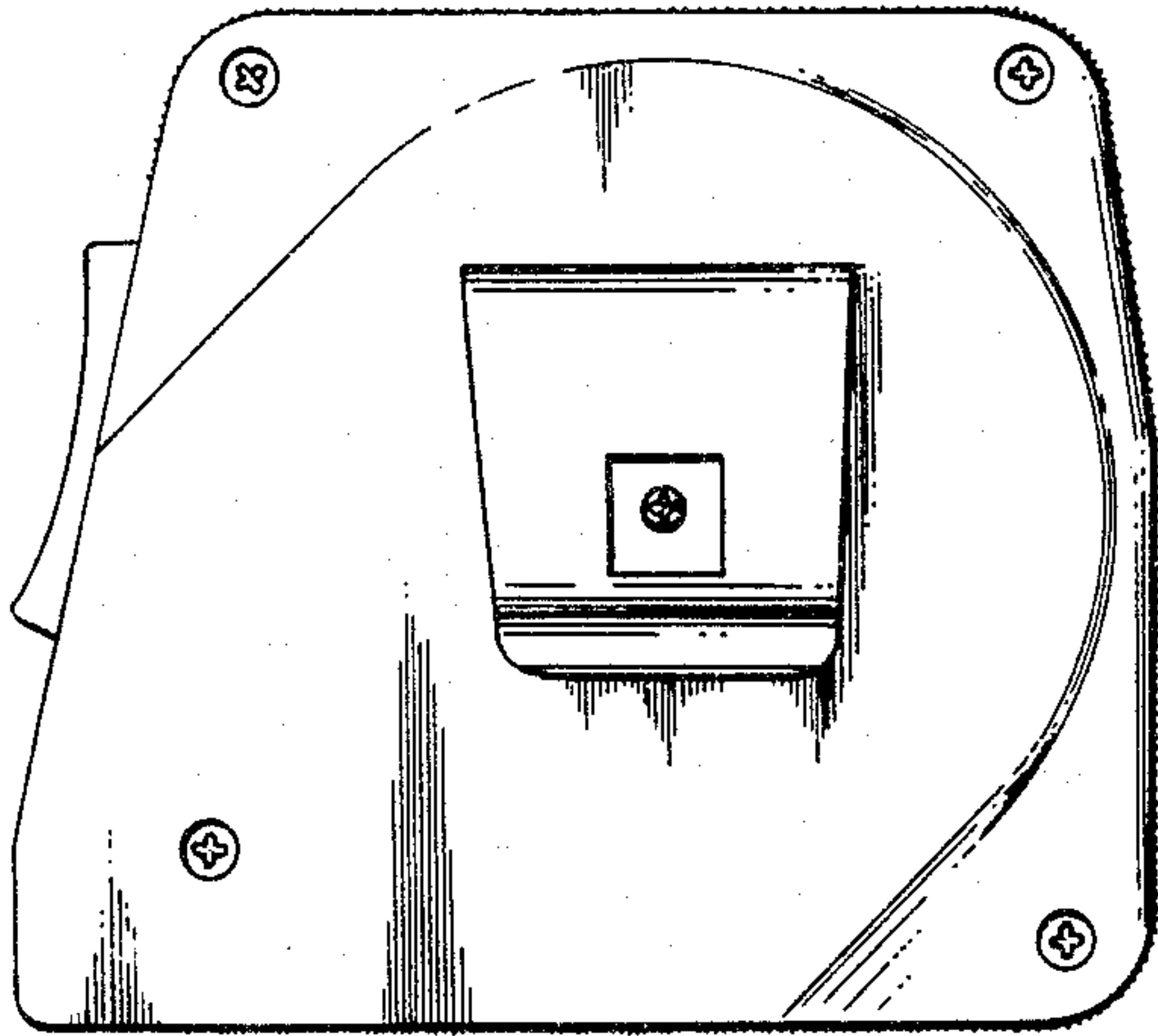

FIG. 5

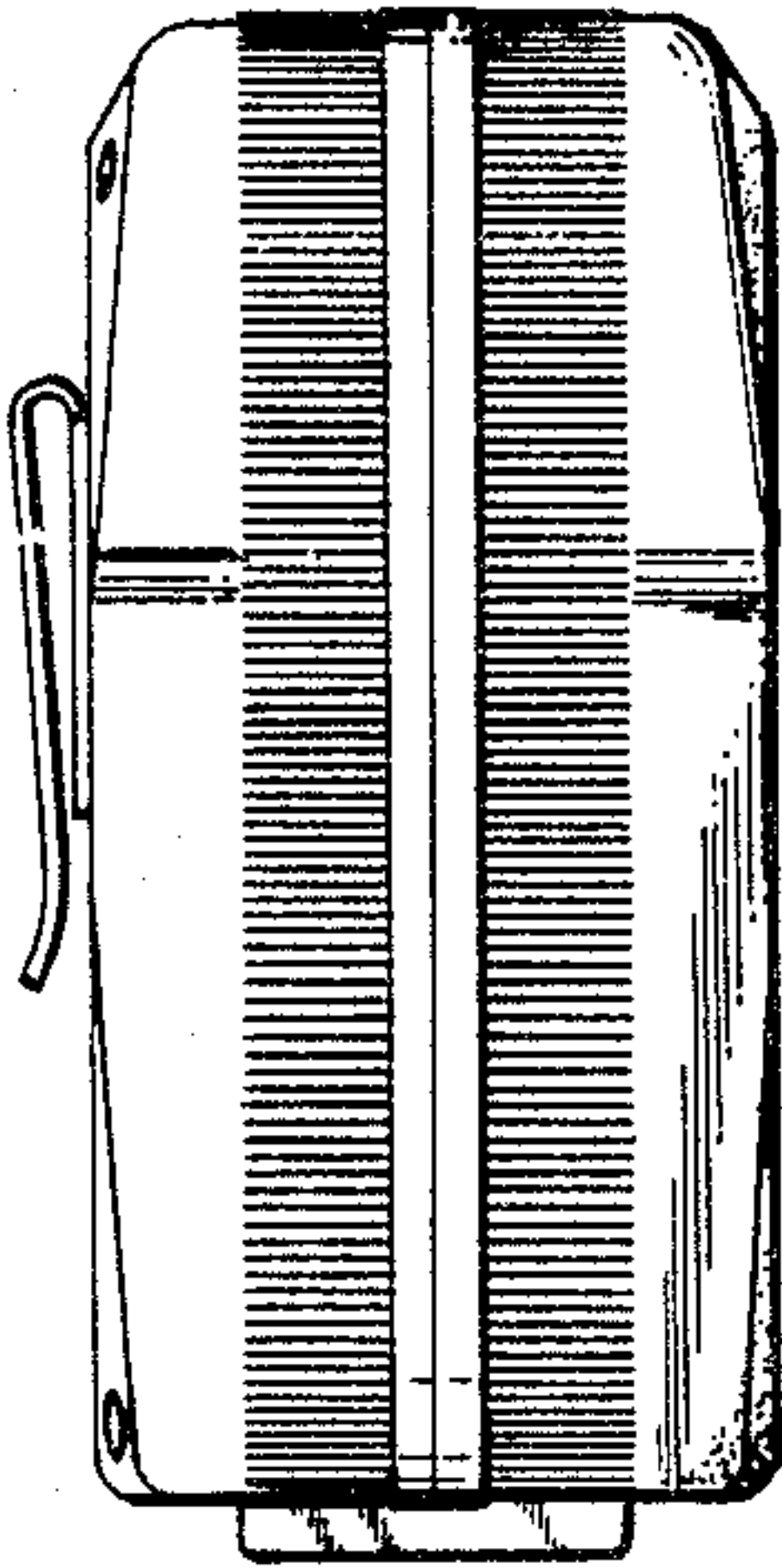

FIG. 6

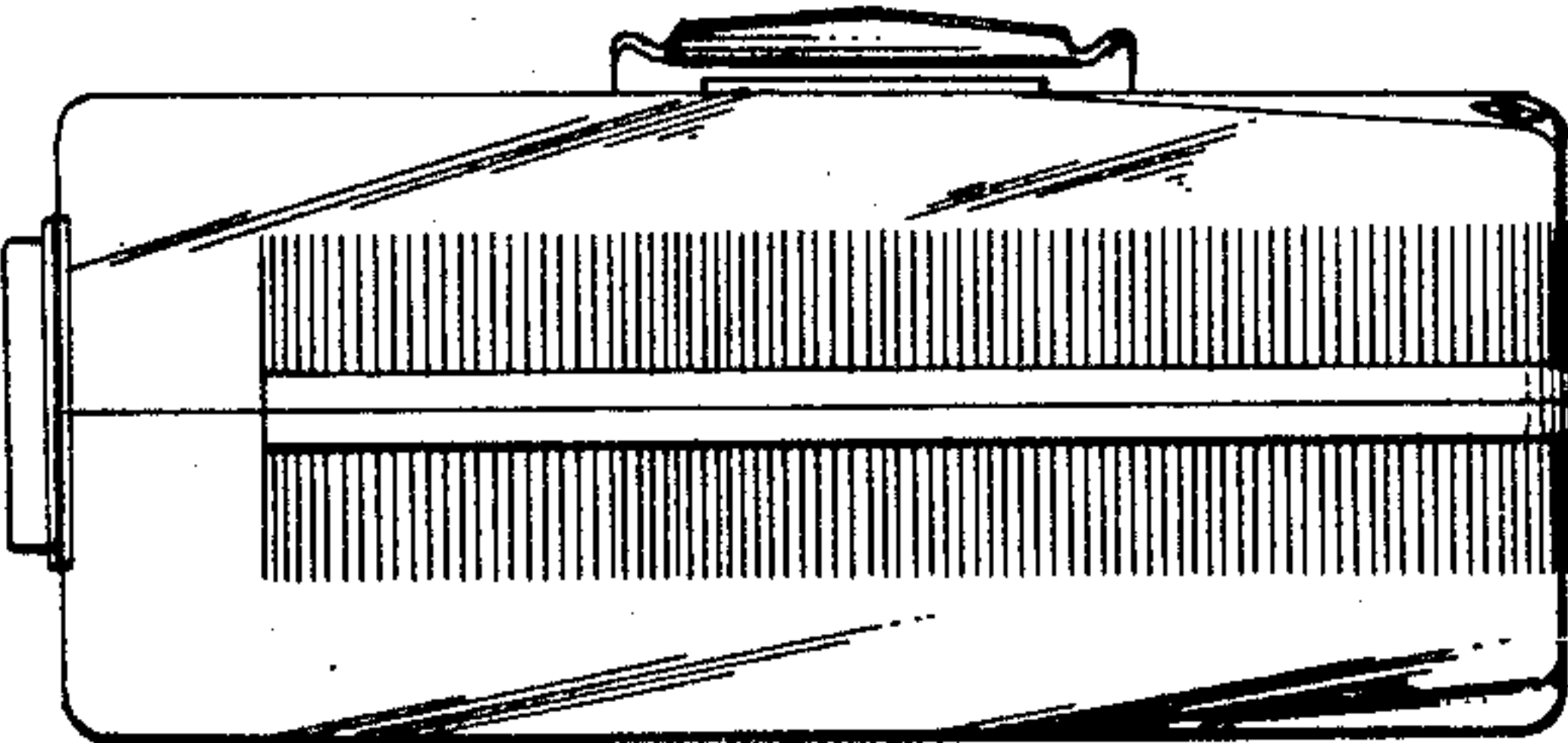

FIG. 7