

[54] EAR MUFFS

[76] Inventor: Richard D. Pozzini, 5545 Dugan Ave., St. Louis, Mo. 63110

[**] Term: 14 Years

[21] Appl. No.: 578,578

[22] Filed: Feb. 9, 1984

[52] U.S. Cl. D29/19

[58] Field of Search D2/259, 230, 233, 431; D14/36; 2/209

[56] References Cited

U.S. PATENT DOCUMENTS

D. 166,399	4/1952	Lattuca	D2/259 X
D. 215,138	9/1969	Mackey	D2/259
D. 247,433	3/1978	Fixler	D14/36
D. 256,068	7/1980	Danat et al.	D2/431
2,314,782	3/1943	Goretsky	2/209

3,085,253 4/1963 Ulrich et al. 2/209

FOREIGN PATENT DOCUMENTS

342384 2/1931 United Kingdom 2/209

Primary Examiner—Carmen H. Vales
Attorney, Agent, or Firm—Haverstock, Garrett & Roberts

[57] CLAIM

The ornamental design for ear muffs, as shown and described.

DESCRIPTION

FIG. 1 is a right side elevational view of the ear muffs showing my new design;
FIG. 2 is a left side elevational view thereof;
FIG. 3 is a top plan view thereof;
FIG. 4 is a bottom plan view thereof;
FIG. 5 is a front elevational view thereof; and
FIG. 6 is a rear elevational view thereof.

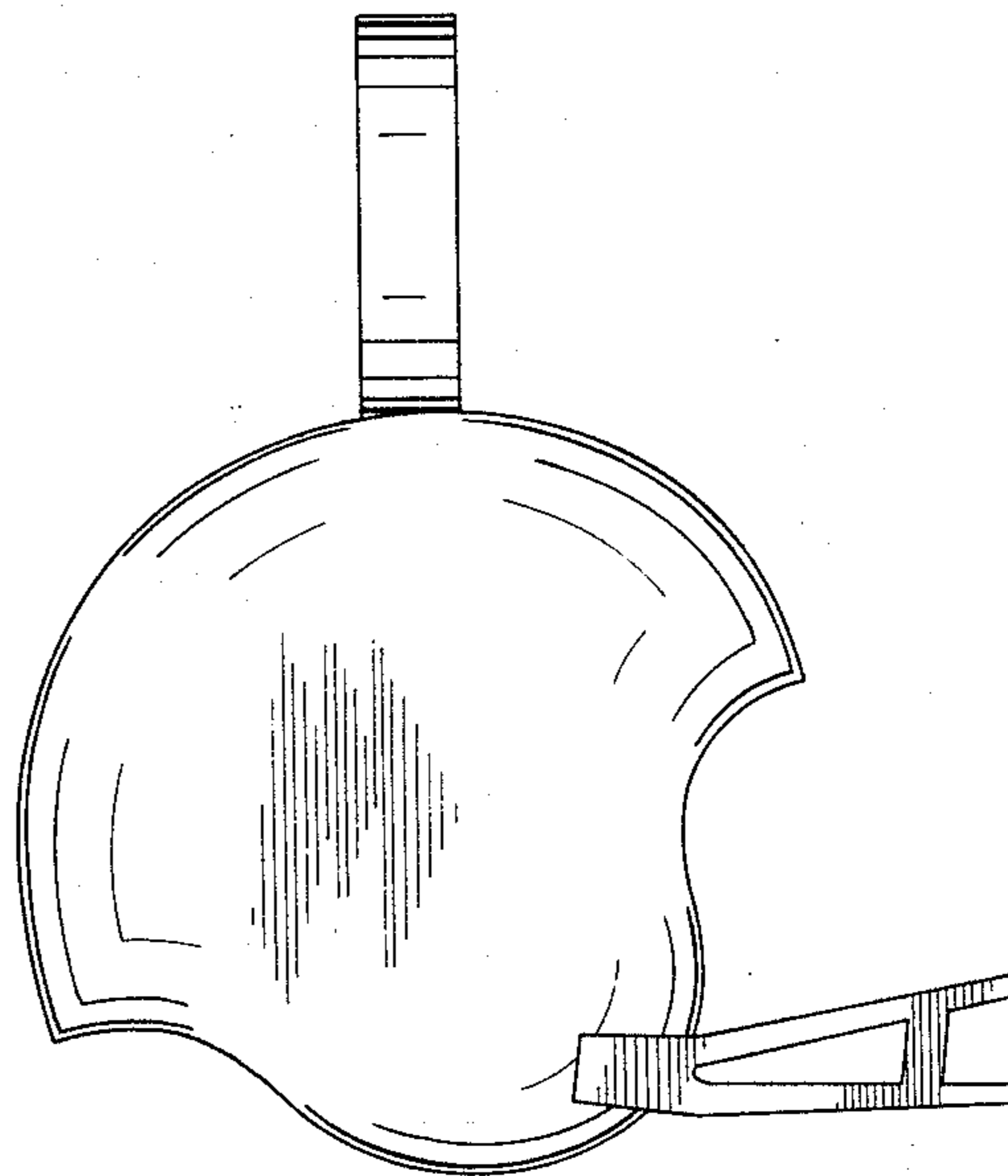
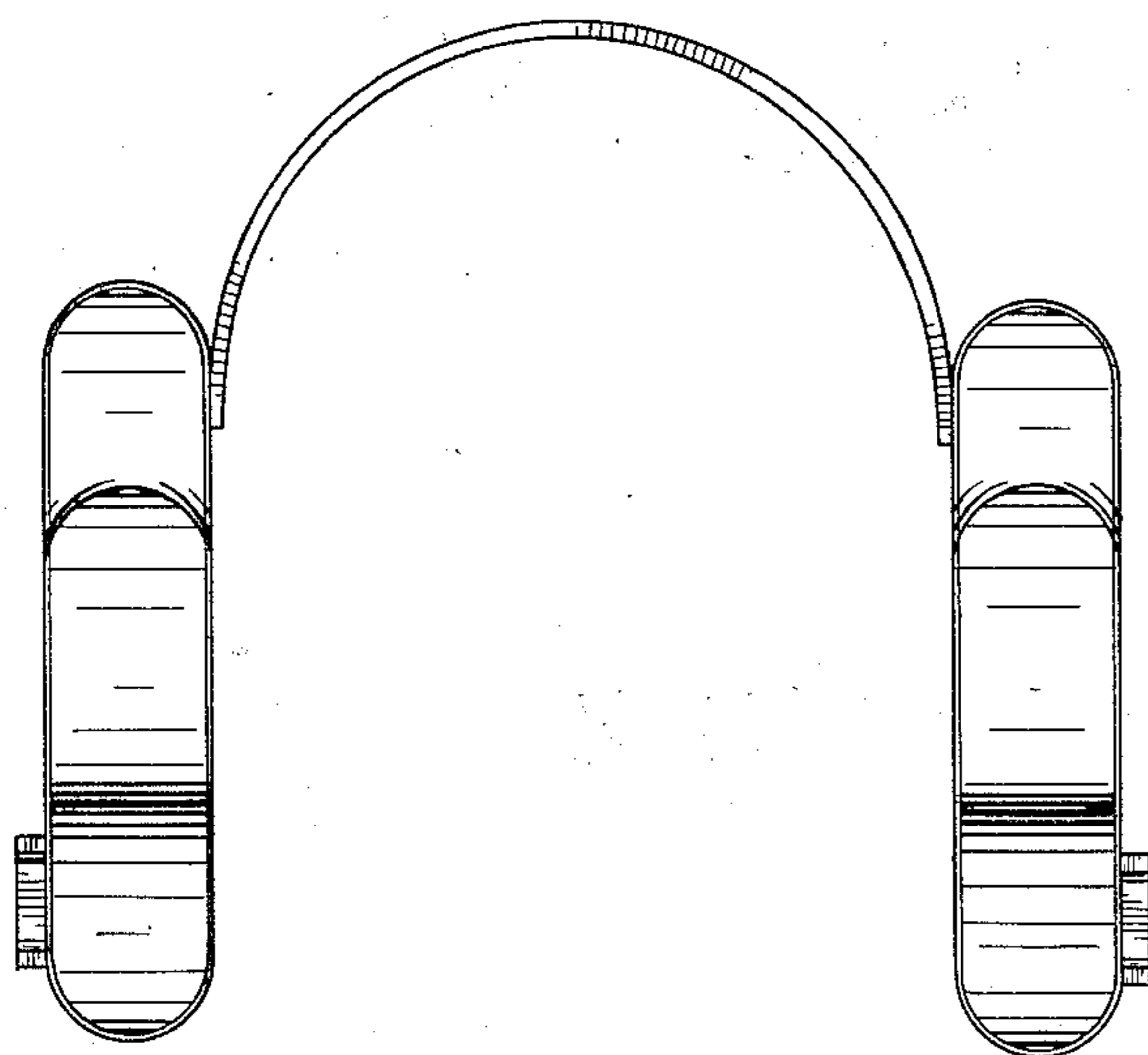

FIG. 1

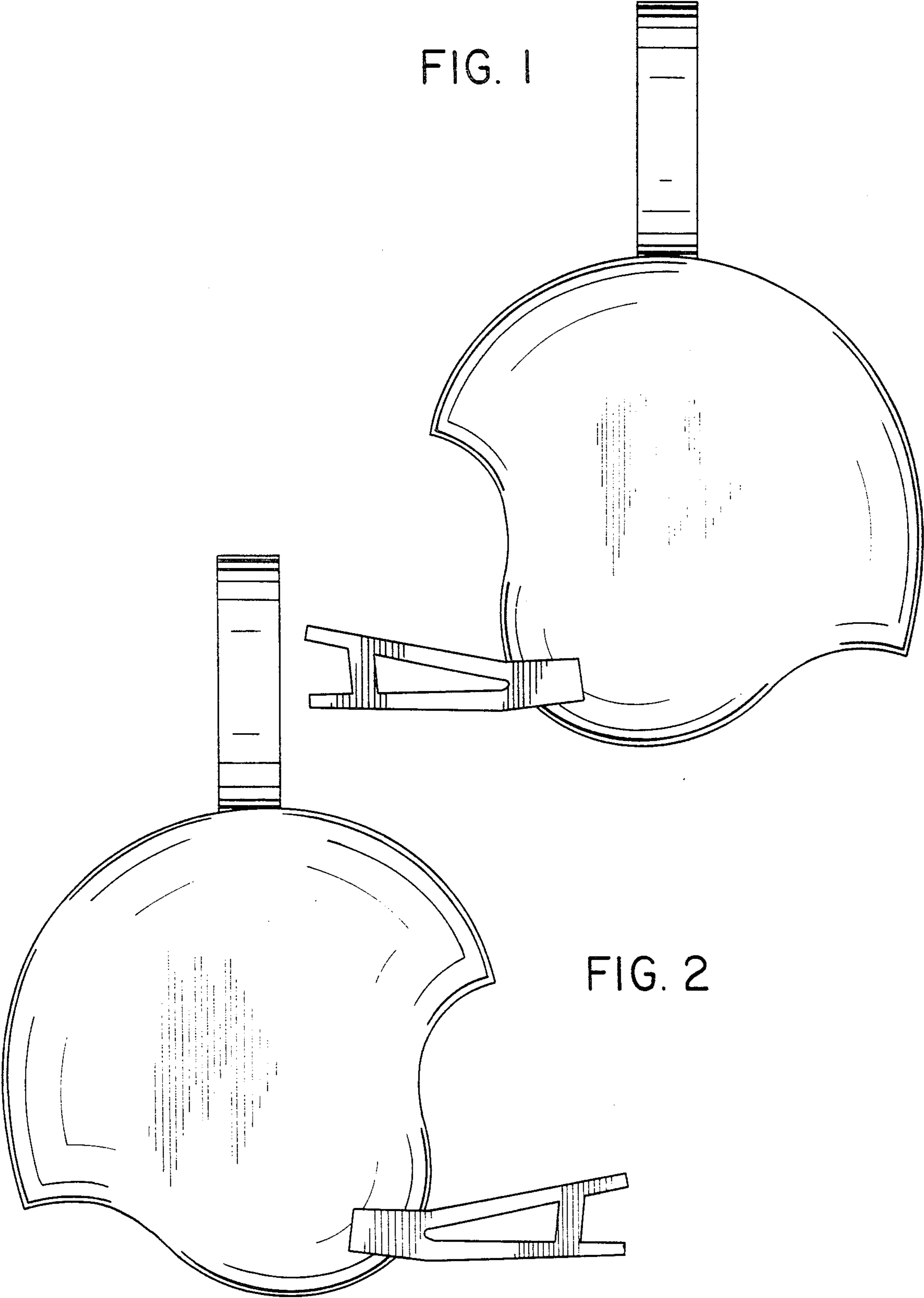

FIG. 3

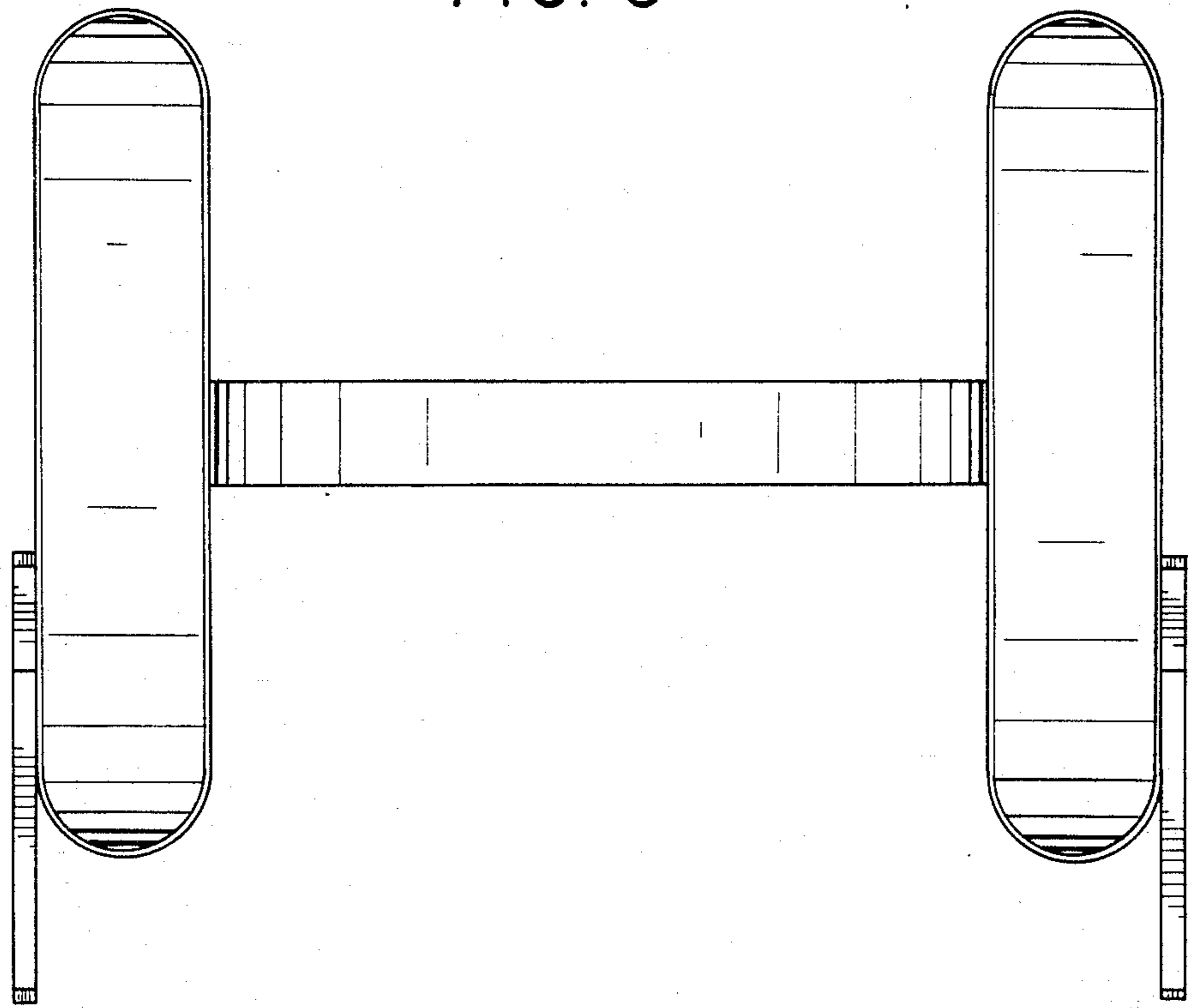

FIG. 4

