

[54] CASE FOR A COMPACT DISC SURFACE CLEANING DEVICE AND COMPACT DISC CLEANING SUPPORT

[75] Inventor: Hirokazu Kawabe, Tokyo, Japan

[73] Assignee: Kabushiki Kaisha Nagaoka, Japan

[**] Term: 14 Years

[21] Appl. No.: 604,535

[22] Filed: Apr. 27, 1984

[30] Foreign Application Priority Data

Feb. 1, 1984 [JP] Japan 59-3478

[52] U.S. Cl. D32/35

[58] Field of Search D14/100-116; 360/133, 137; 206/309, 310, 313, 444; D32/35; 369/72; 15/114, 210 R

[56] References Cited

U.S. PATENT DOCUMENTS

- 4,023,677 5/1977 Wittner et al. 15/114 X
- 4,155,448 5/1979 Horian et al. 15/114 X
- 4,569,098 2/1986 Kawabe 15/114

Primary Examiner—Susan J. Lucas
Attorney, Agent, or Firm—James E. Nilles

[57] CLAIM

The ornamental design for a case for a compact disc surface cleaning device and compact disc cleaning support, as shown and described.

DESCRIPTION

FIG. 1 is a plan view of a disc-cleaning device showing my new design;

FIG. 2 is a front elevational view thereof;

FIG. 3 is a bottom view thereof;

FIG. 4 is a right side view thereof; the opposite side being a mirror image of the side shown;

FIG. 5 is a rear elevational view thereof; and

FIG. 6 is a perspective view thereof but on a reduced scale.

The case is shaded to indicate translucent material.

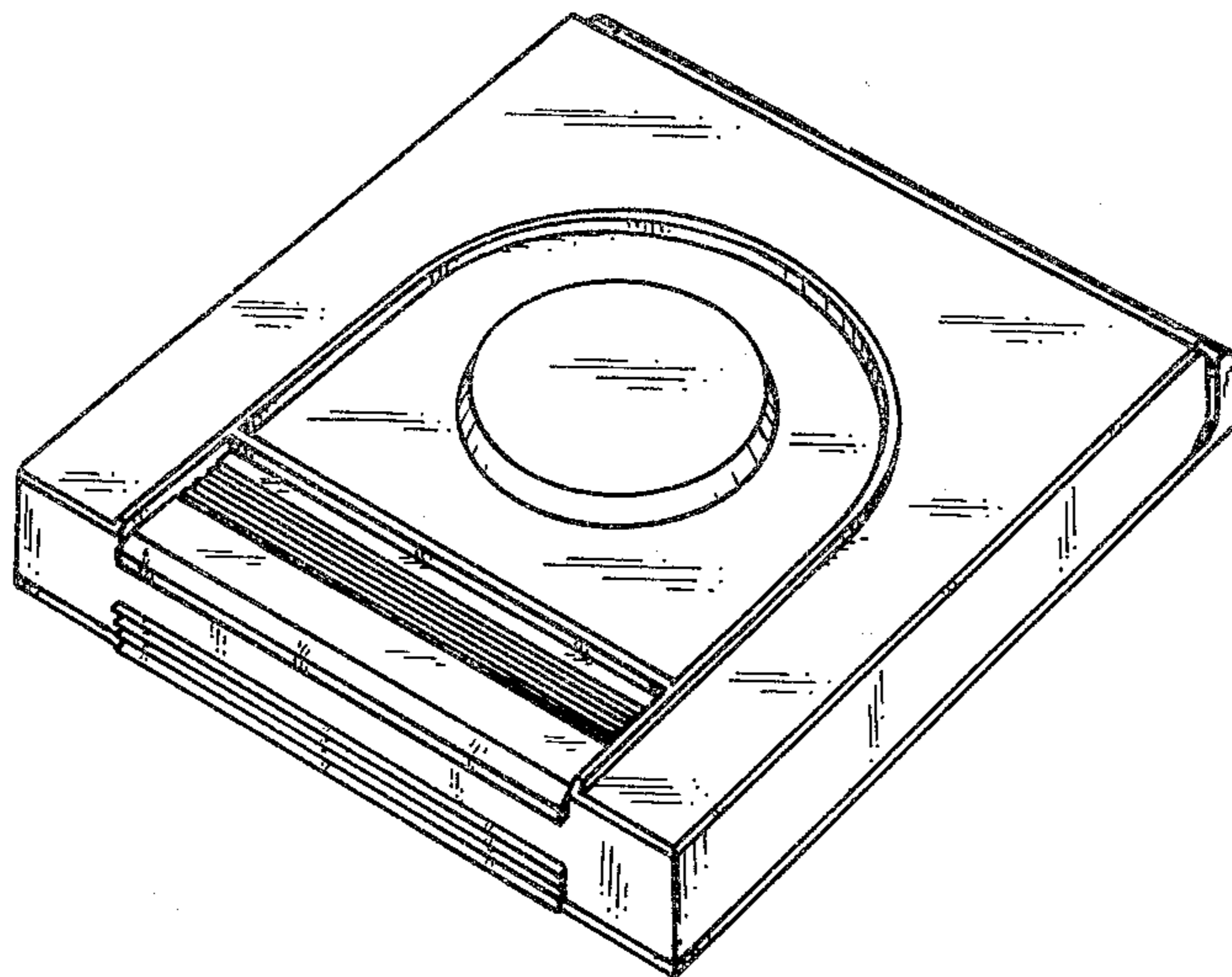

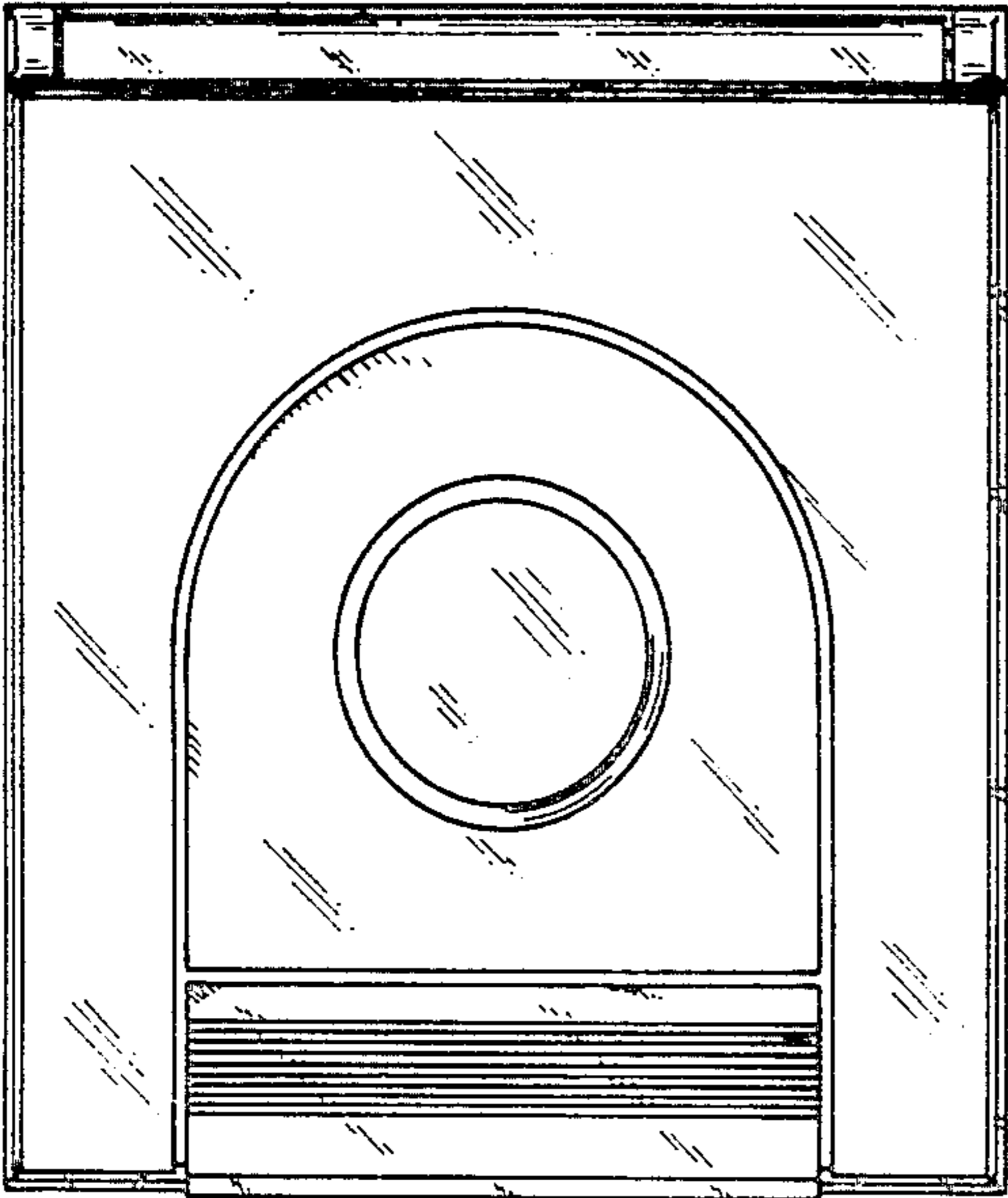

FIG. 1

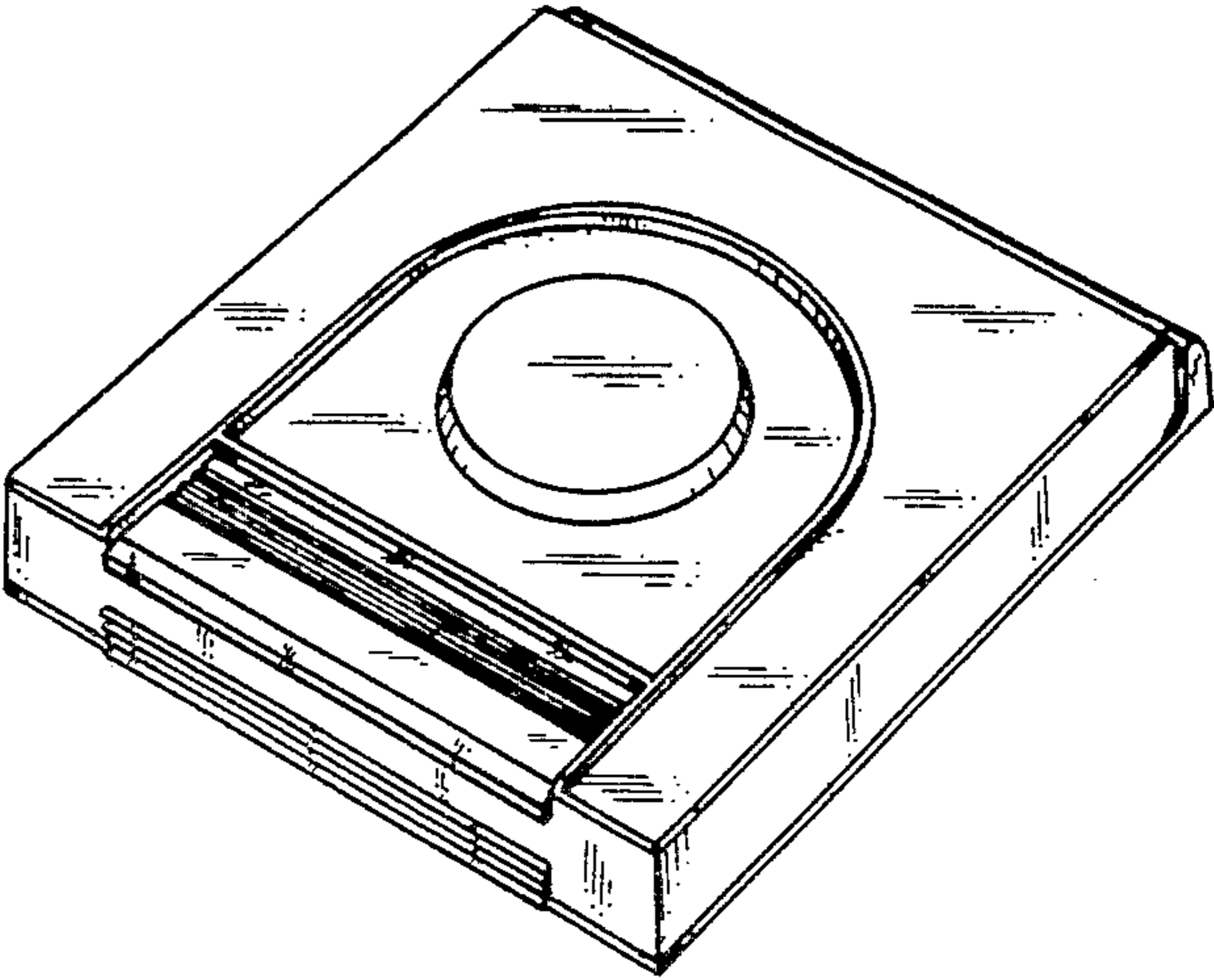

FIG. 6

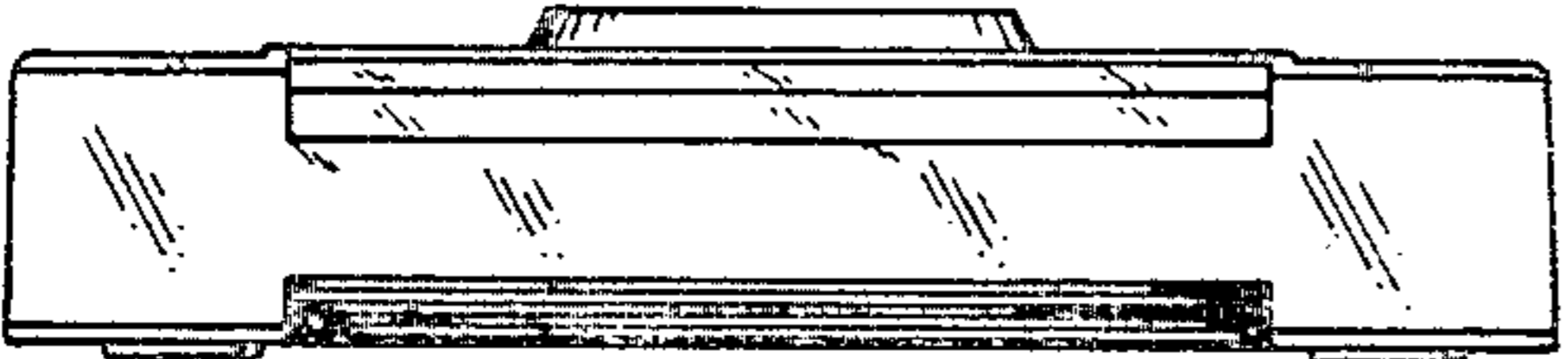

FIG. 2

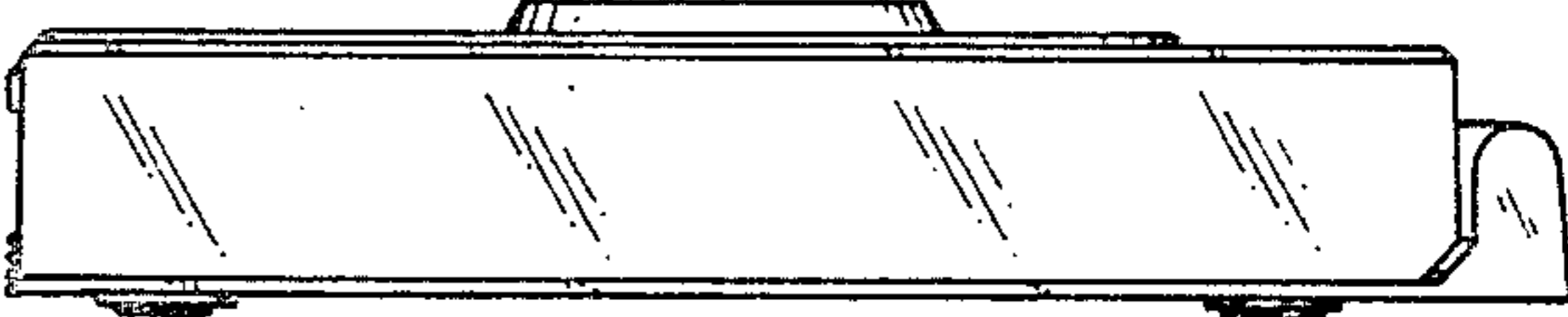

FIG. 4

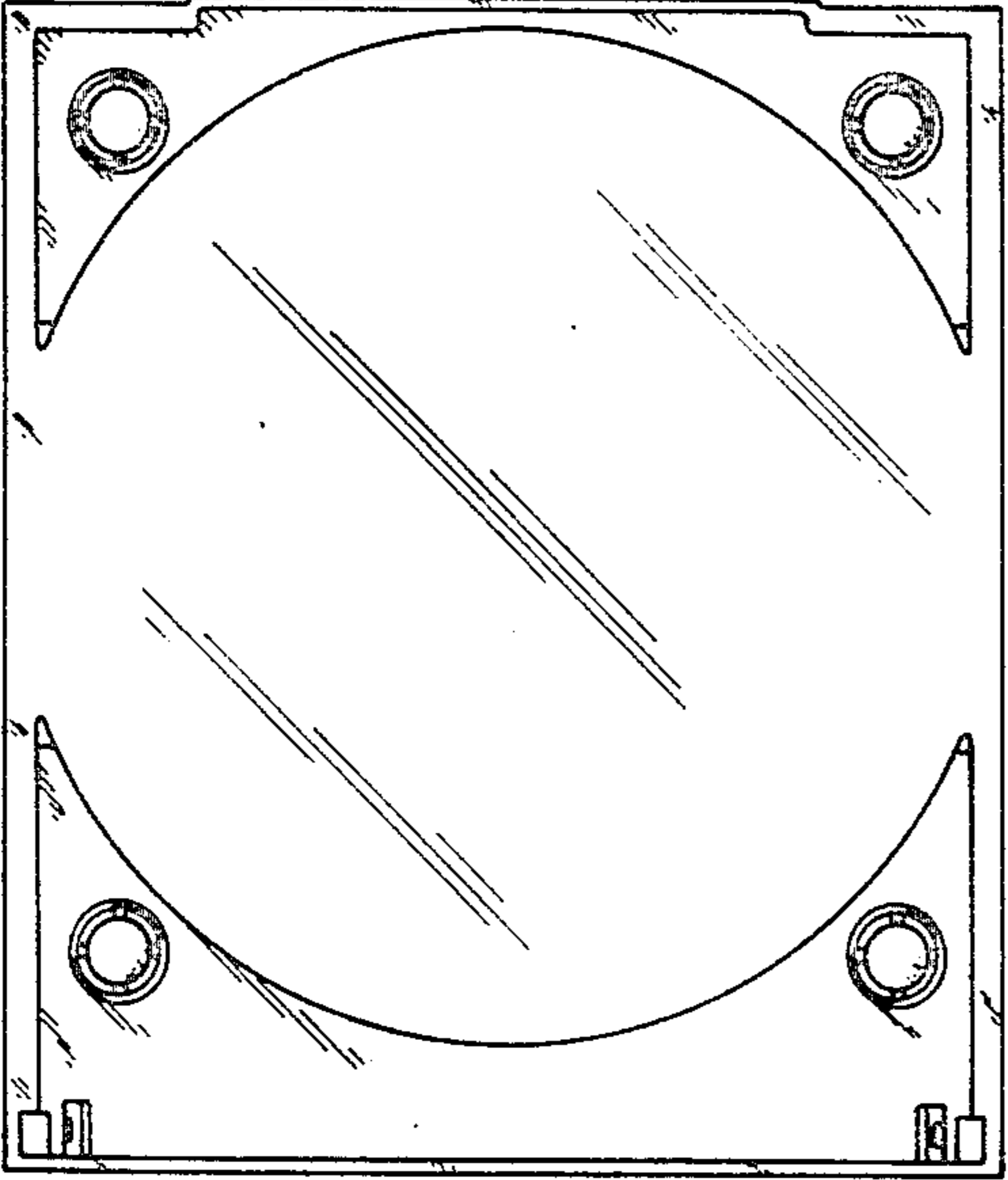

FIG. 3

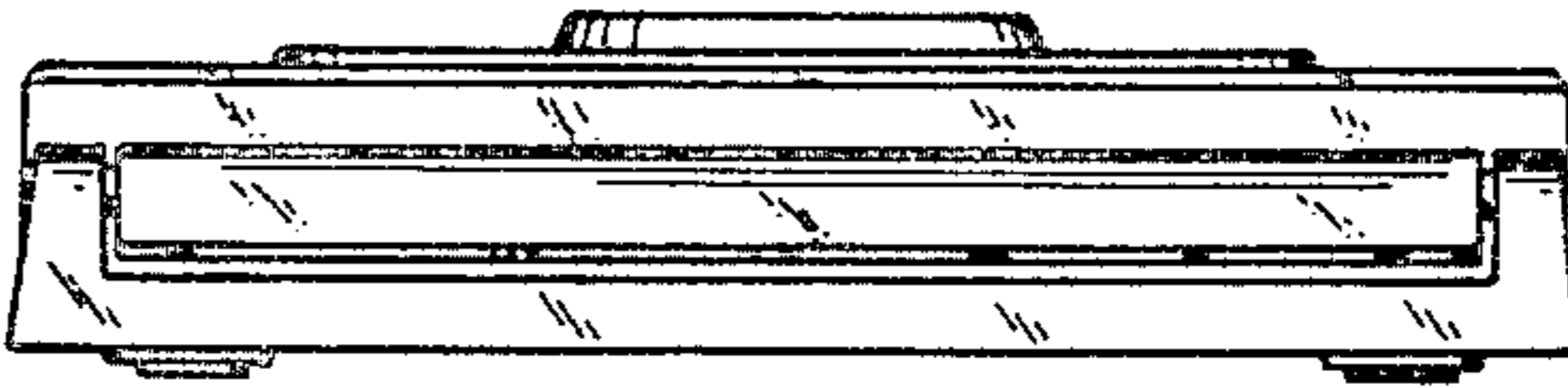

FIG. 5