

[54] **HOLDER FOR A PAGER**
 [75] **Inventor: Takashi Oyamada, Tokyo, Japan**
 [73] **Assignee: NEC Corporation, Tokyo, Japan**
 [**] **Term: 14 Years**
 [21] **Appl. No.: 611,555**
 [22] **Filed: May 17, 1984**

[30] **Foreign Application Priority Data**
 Nov. 17, 1983 [JP] Japan 58-50052
 [52] **U.S. Cl. D3/106**
 [58] **Field of Search D2/400, 402; D14/70, D14/68; 24/3 E, 3 J; 224/148, 269, 253; 248/229; 455/351**

[56] **References Cited**
U.S. PATENT DOCUMENTS
 D. 277,753 2/1985 Eckmann et al. D14/70
 D. 278,853 5/1985 Takata D2/400
 D. 279,342 6/1985 Crawford D2/400 X
 D. 281,975 12/1985 Oyamada D14/70
 1,756,677 4/1930 Cook 224/253 X

2,552,844 5/1951 Clinehens 224/148 X
 3,117,759 1/1964 Herer 224/148 X
 3,956,701 5/1976 James, Jr. et al. 455/351 X
 4,046,295 9/1977 Eichler 224/253 X
 4,536,925 8/1985 Boothe et al. 24/3 J X

Primary Examiner—Bernard Ansher
Assistant Examiner—Linda Titolo
Attorney, Agent, or Firm—Sughrue, Mion, Zinn, Macpeak, and Seas

[57] **CLAIM**
 The ornamental design for a holder for a pager, as shown.

DESCRIPTION
 FIG. 1 is a front elevational view of a holder for a pager showing my new design;
 FIG. 2 is a rear elevational view thereof;
 FIG. 3 is a top plan view thereof;
 FIG. 4 is a bottom plan view thereof;
 FIG. 5 is a right side elevational view thereof;
 FIG. 6 is a left side elevational view thereof; and
 FIG. 7 is a top front and right side perspective view thereof.

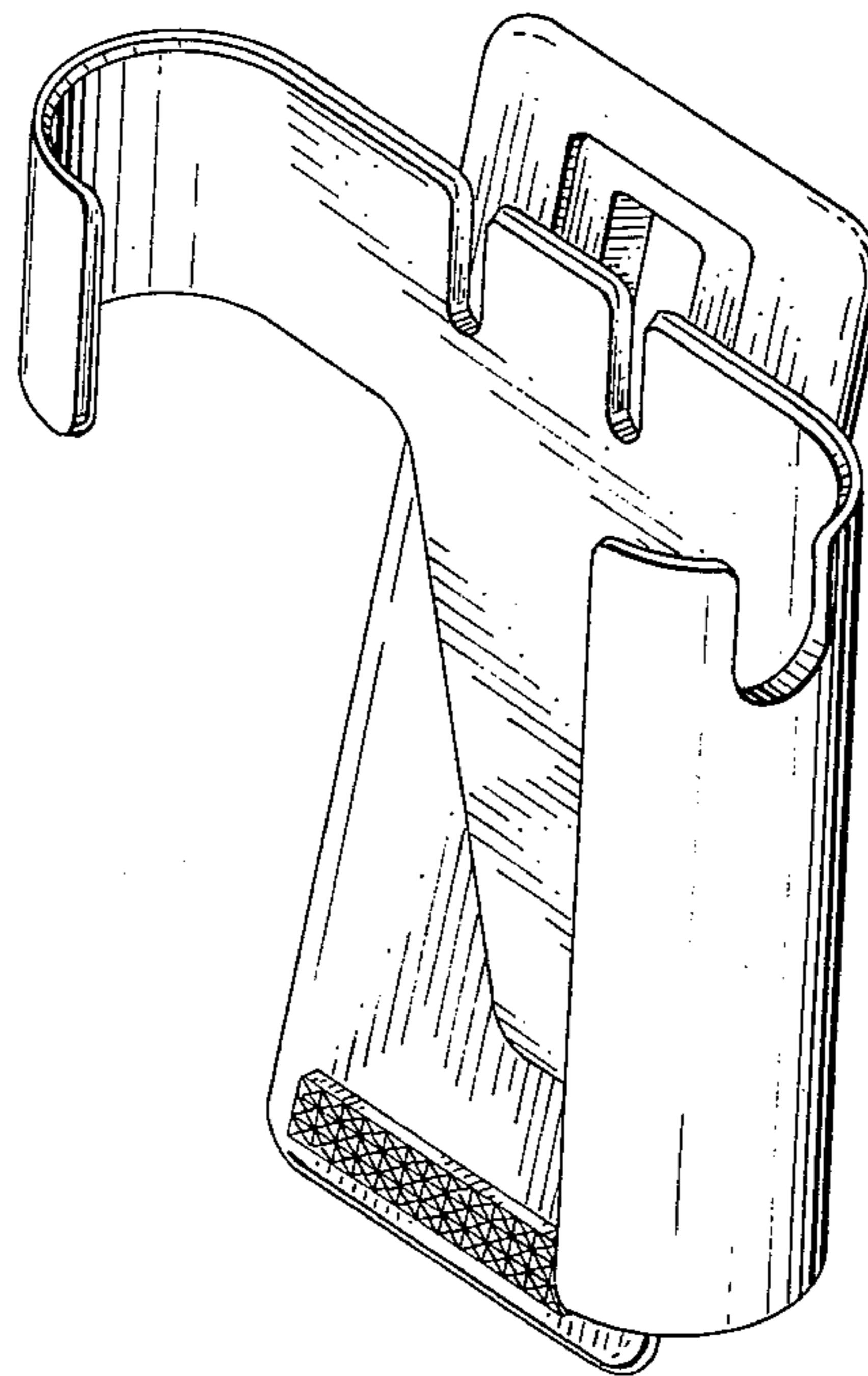

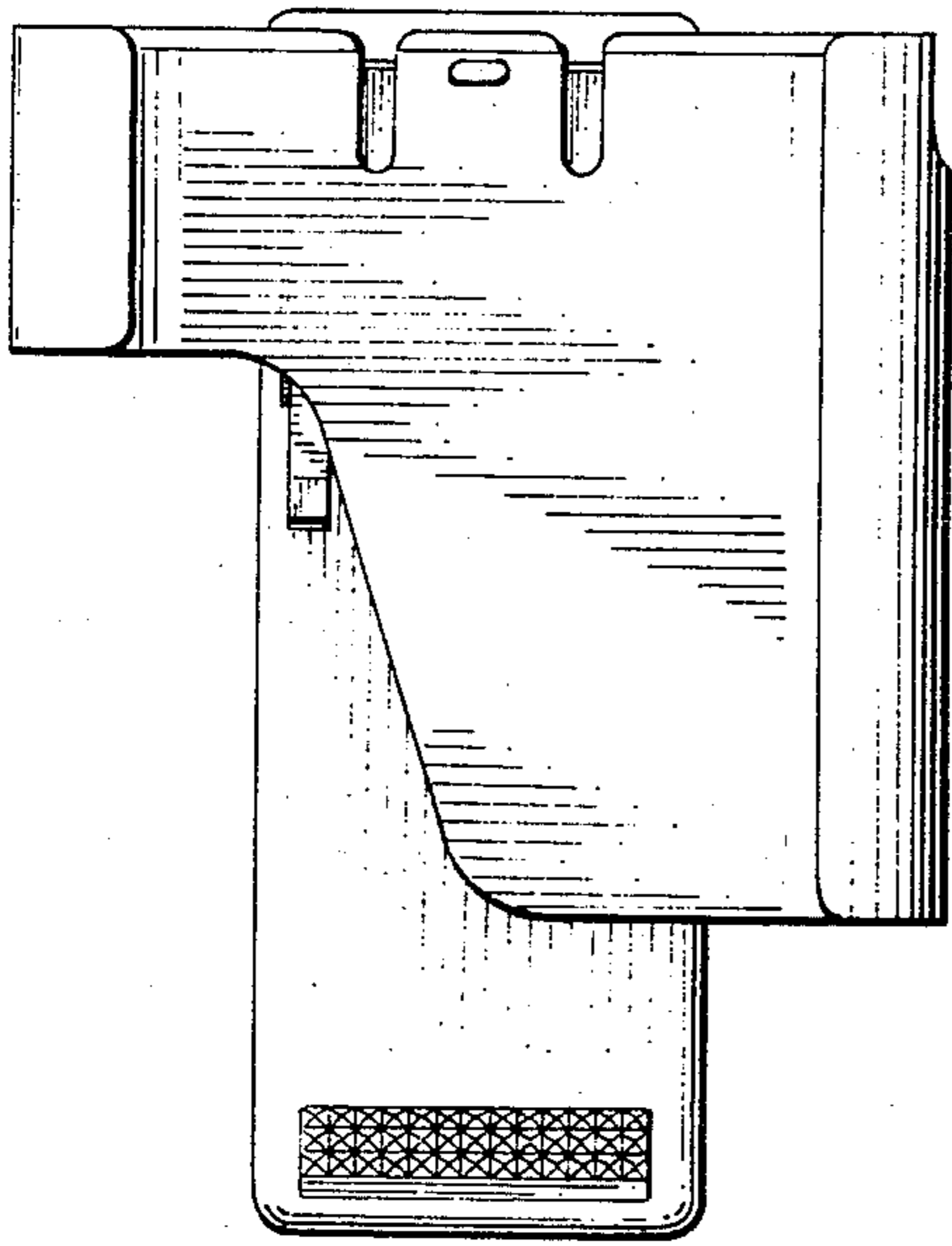

FIG. 1

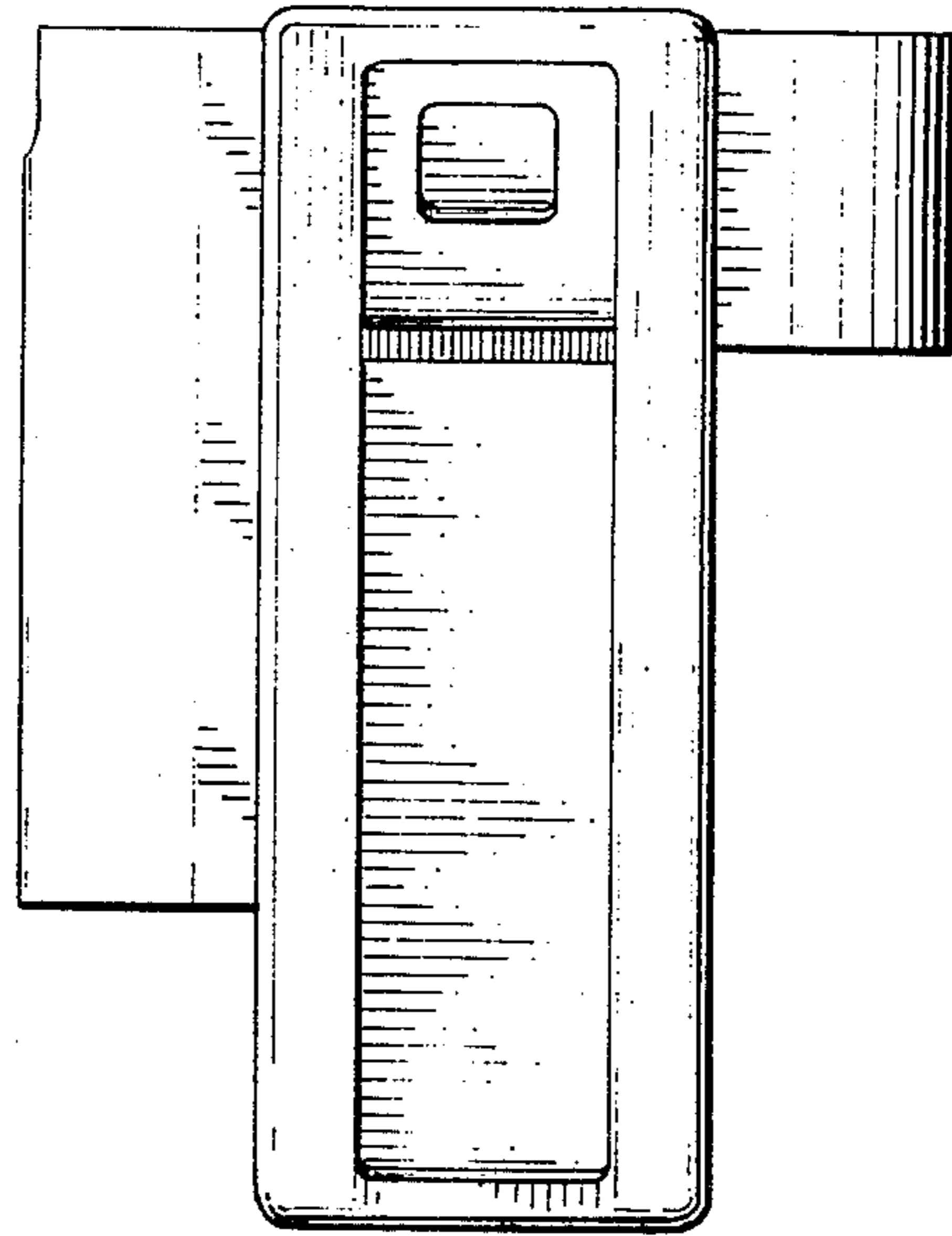

FIG. 2

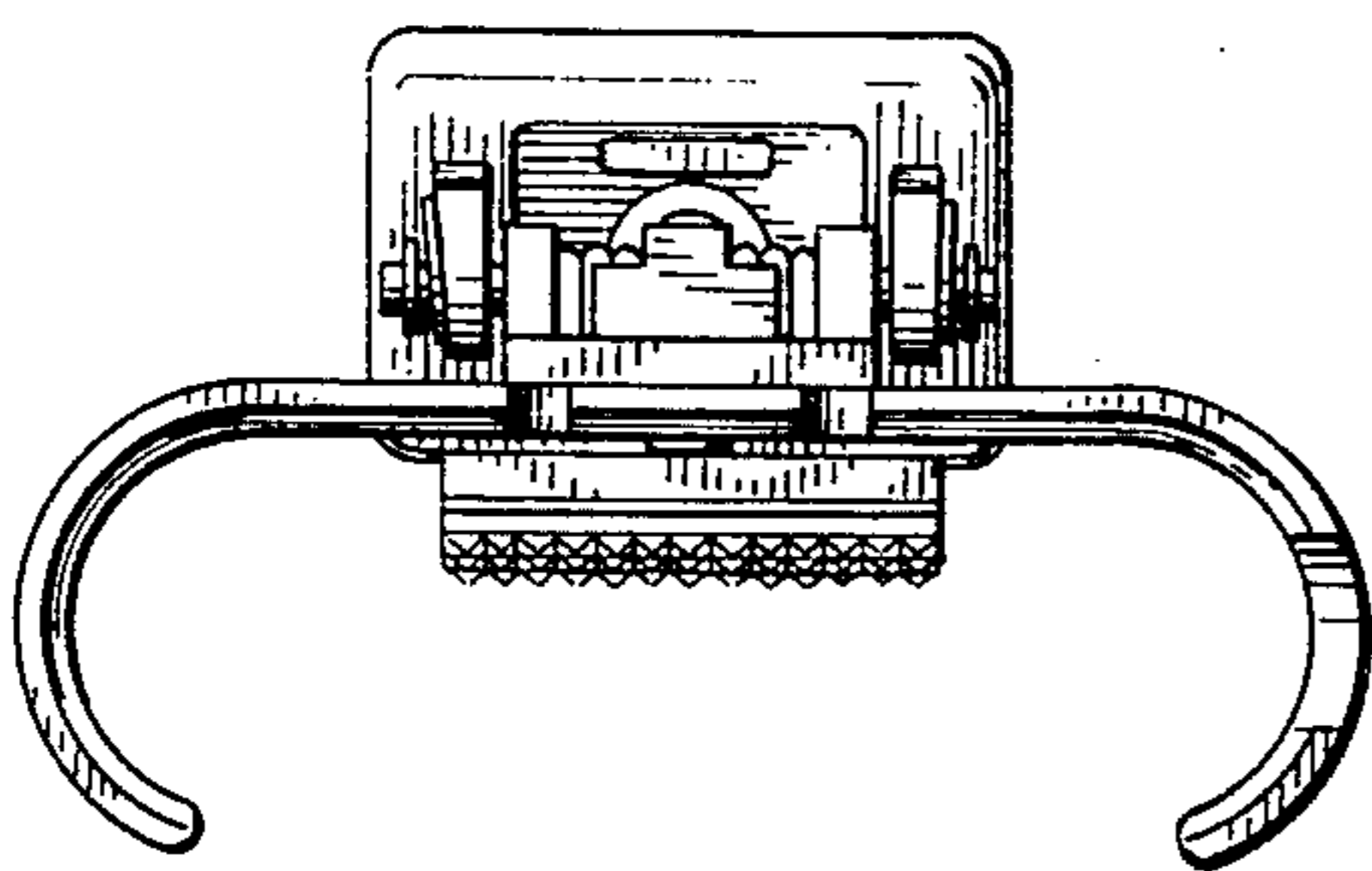

FIG. 3

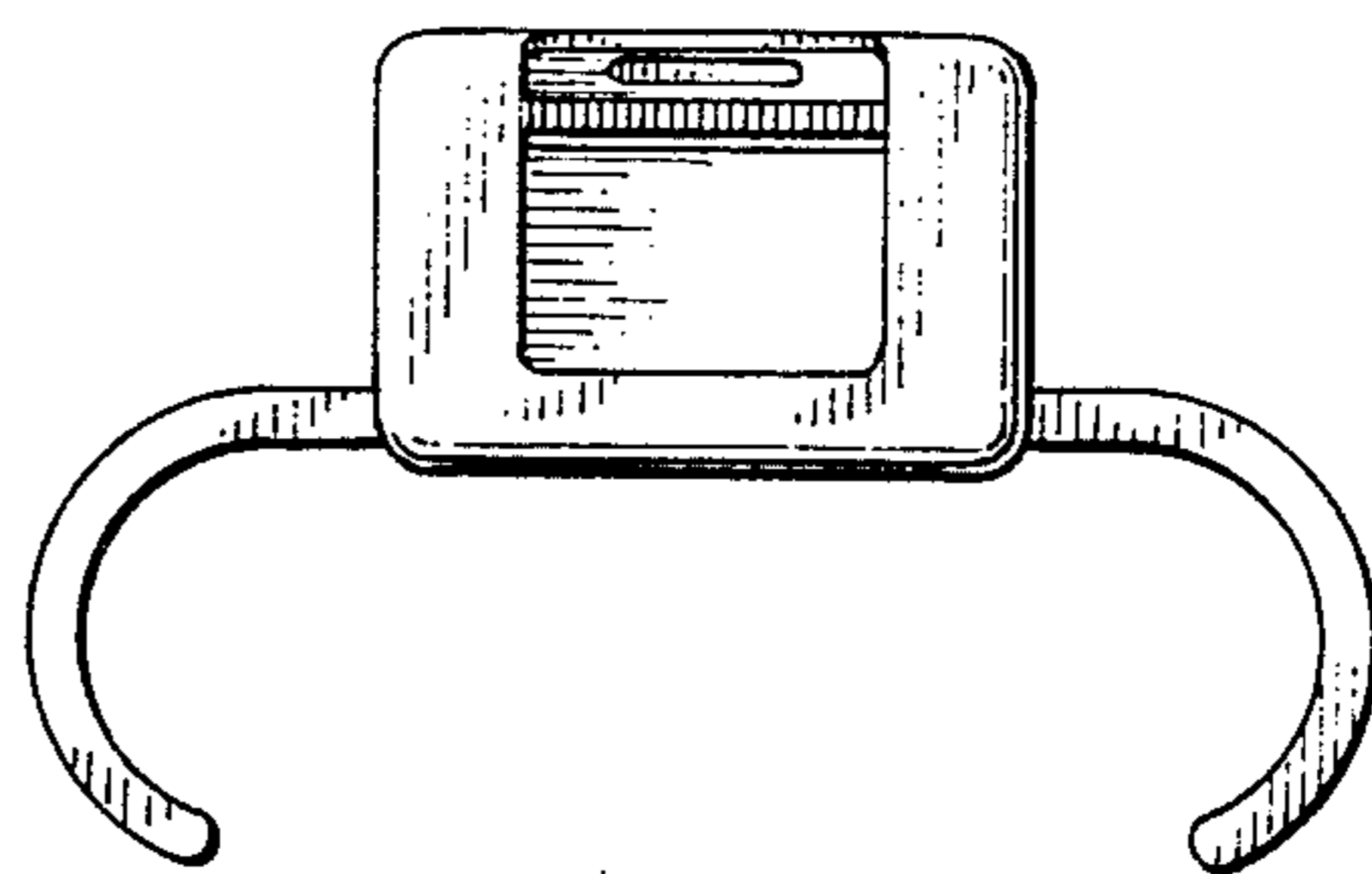

FIG. 4

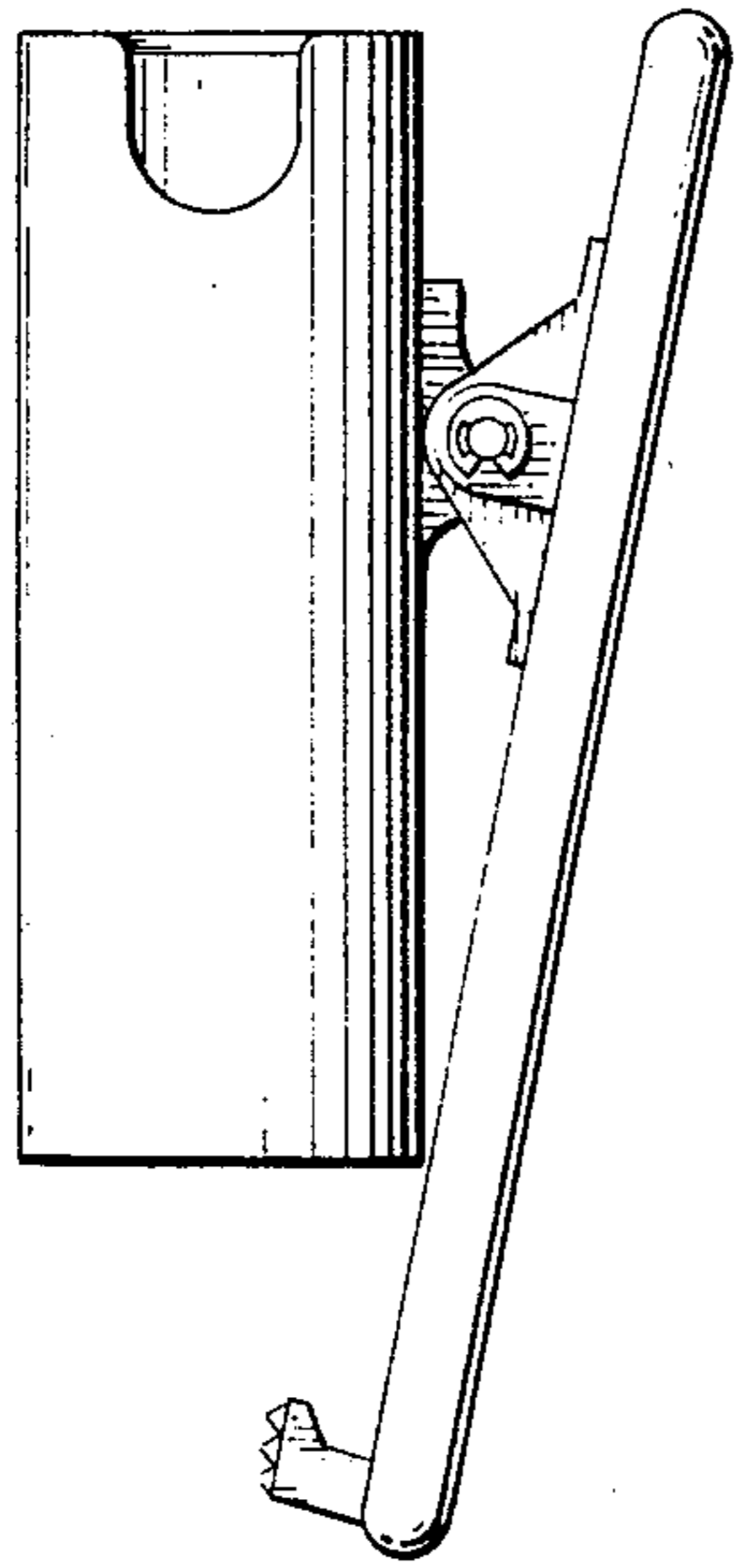

FIG. 5

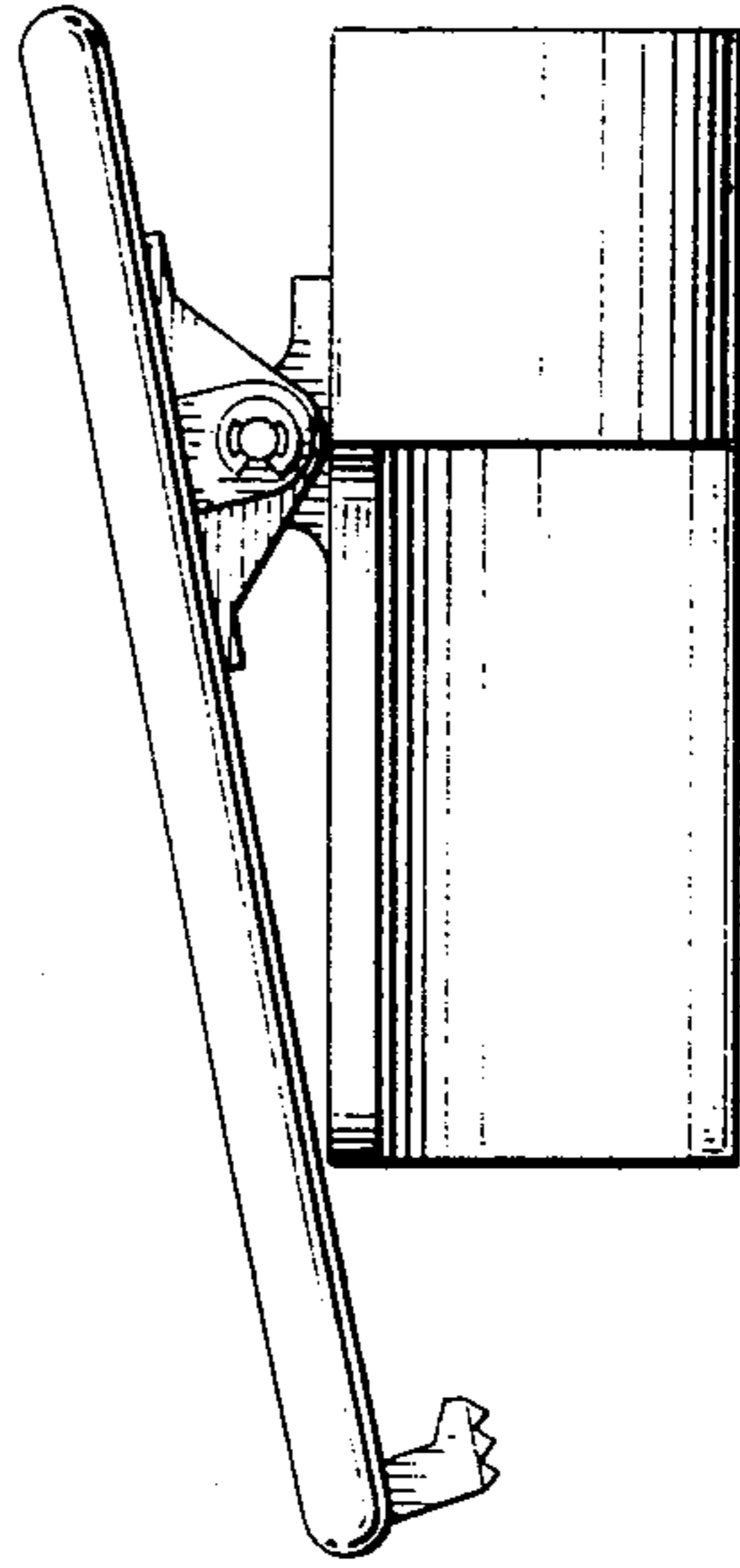

FIG. 6

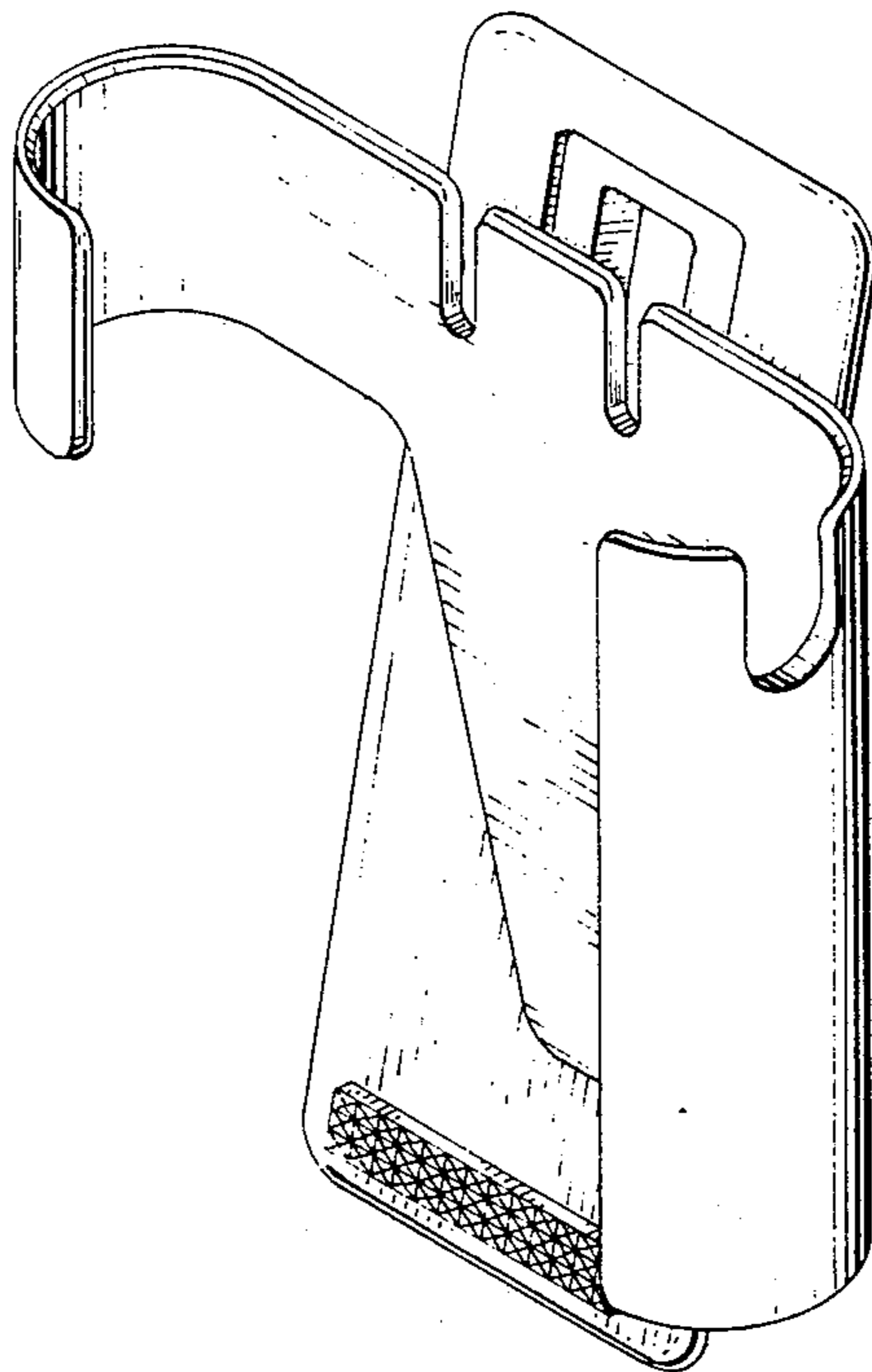

FIG. 7