

[54] GARMET STEAMER

[75] Inventors: Richard L. Rosa, Sebastopol; Edward H. Gauer, Jr., Geyserville, both of Calif.

[73] Assignee: Hybrinetics, Inc., Santa Rosa, Calif.

[**] Term: 14 Years

[21] Appl. No.: 603,620

[22] Filed: Apr. 25, 1984

[52] U.S. Cl. D32/17; D32/69

[58] Field of Search D32/17, 69; 68/222; 219/271; 38/77.1

[56] References Cited

U.S. PATENT DOCUMENTS

D. 219,751	1/1971	Osrow	D32/69
D. 221,992	9/1971	Bluestein et al.	D32/17
D. 222,502	10/1971	Madl et al.	D32/69
D. 230,458	2/1974	Hall et al.	D32/69
D. 232,802	9/1974	Steinkamp et al.	D32/17
D. 233,209	10/1974	Terraillon	D32/17
3,646,317	2/1972	Osrow	219/271
3,675,449	7/1972	Bluestein	68/222
3,811,208	5/1974	Viceli et al.	68/222 X

Primary Examiner—Catherine E. Kemper
Attorney, Agent, or Firm—Flehr, Hohbach, Test, Albritton & Herbert

[57] CLAIM

The ornamental design for a garment steamer, as shown and described.

DESCRIPTION

FIG. 1 is a perspective view of a garment steamer, showing my new design;
 FIG. 2 is a right-side elevational view thereof;
 FIG. 3 is a left-side elevational view thereof;
 FIG. 4 is a top plan view thereof;
 FIG. 5 is a bottom plan view thereof;
 FIG. 6 is a front elevational view thereof;
 FIG. 7 is a rear elevational view thereof;
 FIG. 8 is a perspective view of a second embodiment of a new design of a garment steamer;
 FIG. 9 is a right-side elevational view thereof;
 FIG. 10 is a left-side elevational view thereof;
 FIG. 11 is a top plan view thereof;
 FIG. 12 is a bottom plan view thereof;
 FIG. 13 is a front elevational view thereof; and
 FIG. 14 is a rear elevational view thereof.

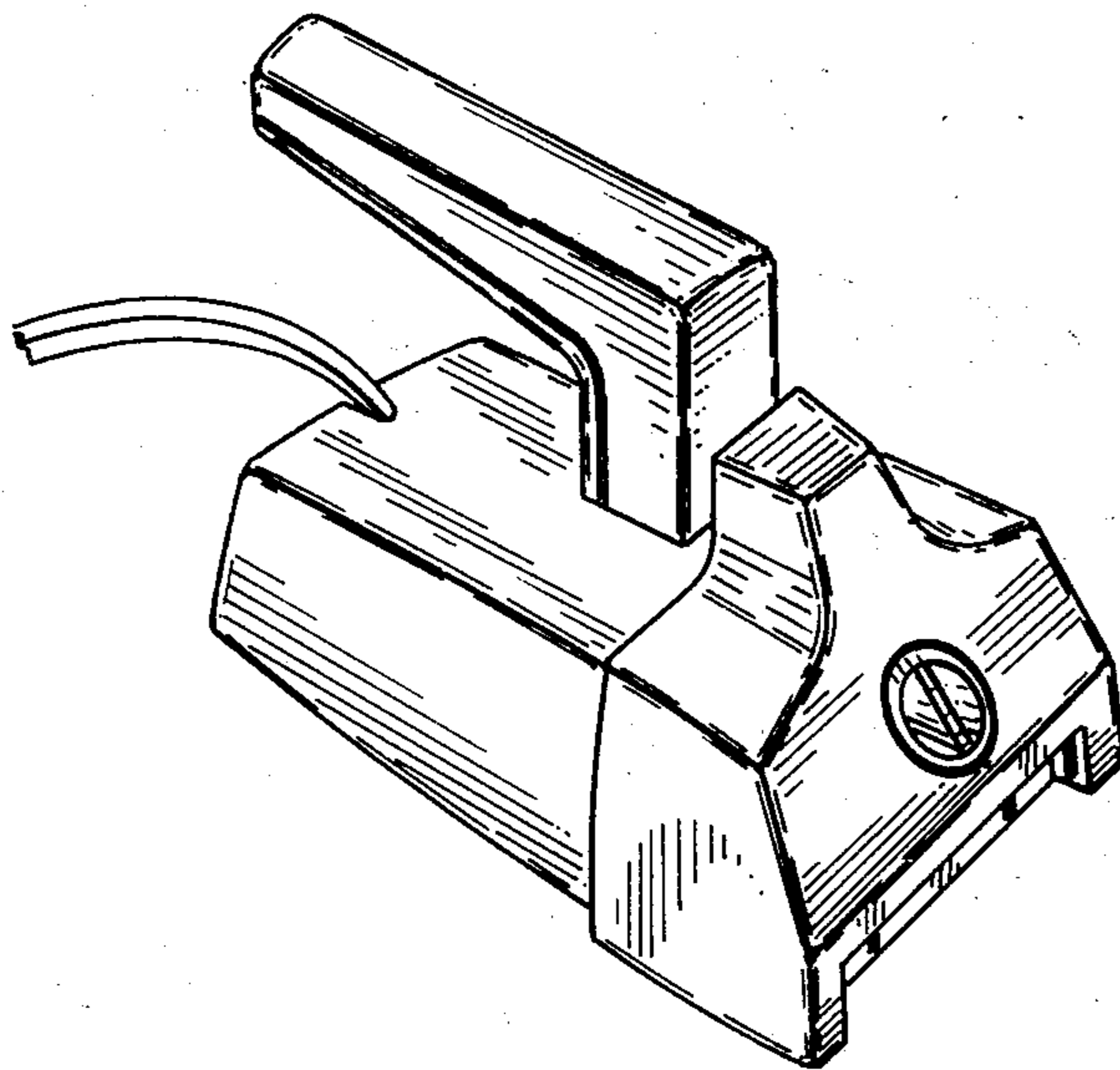

FIG.—1

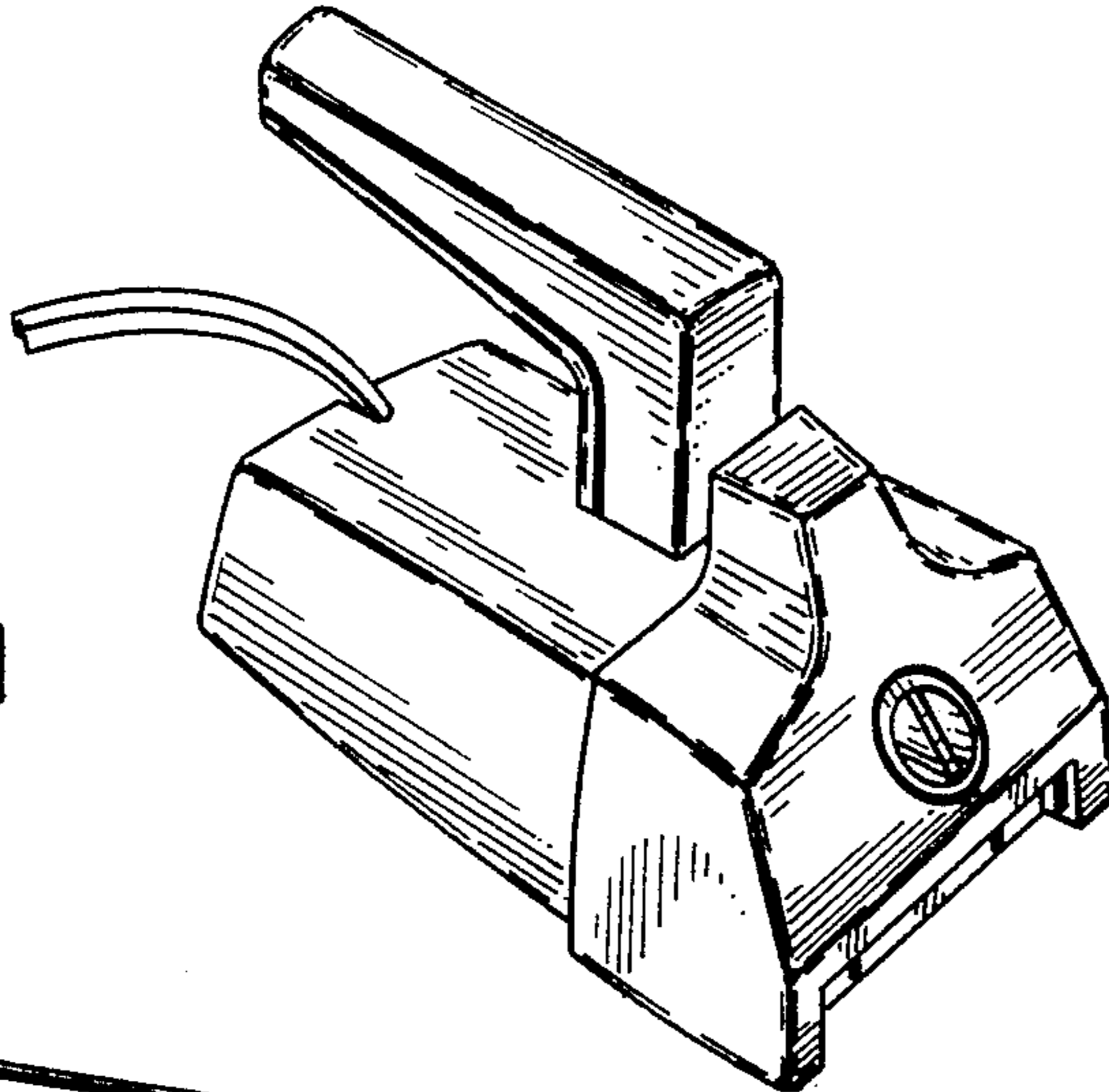

FIG.—2

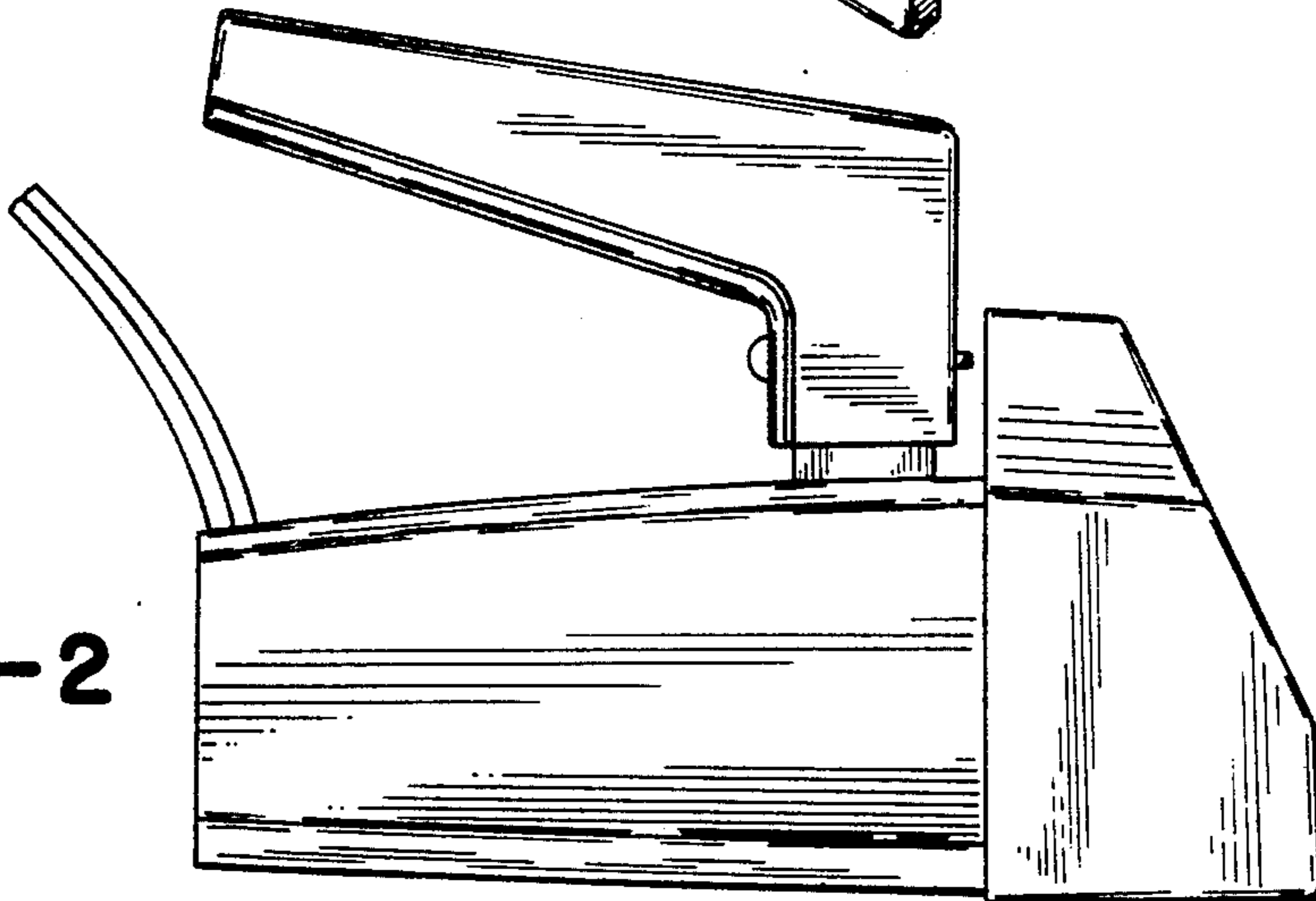
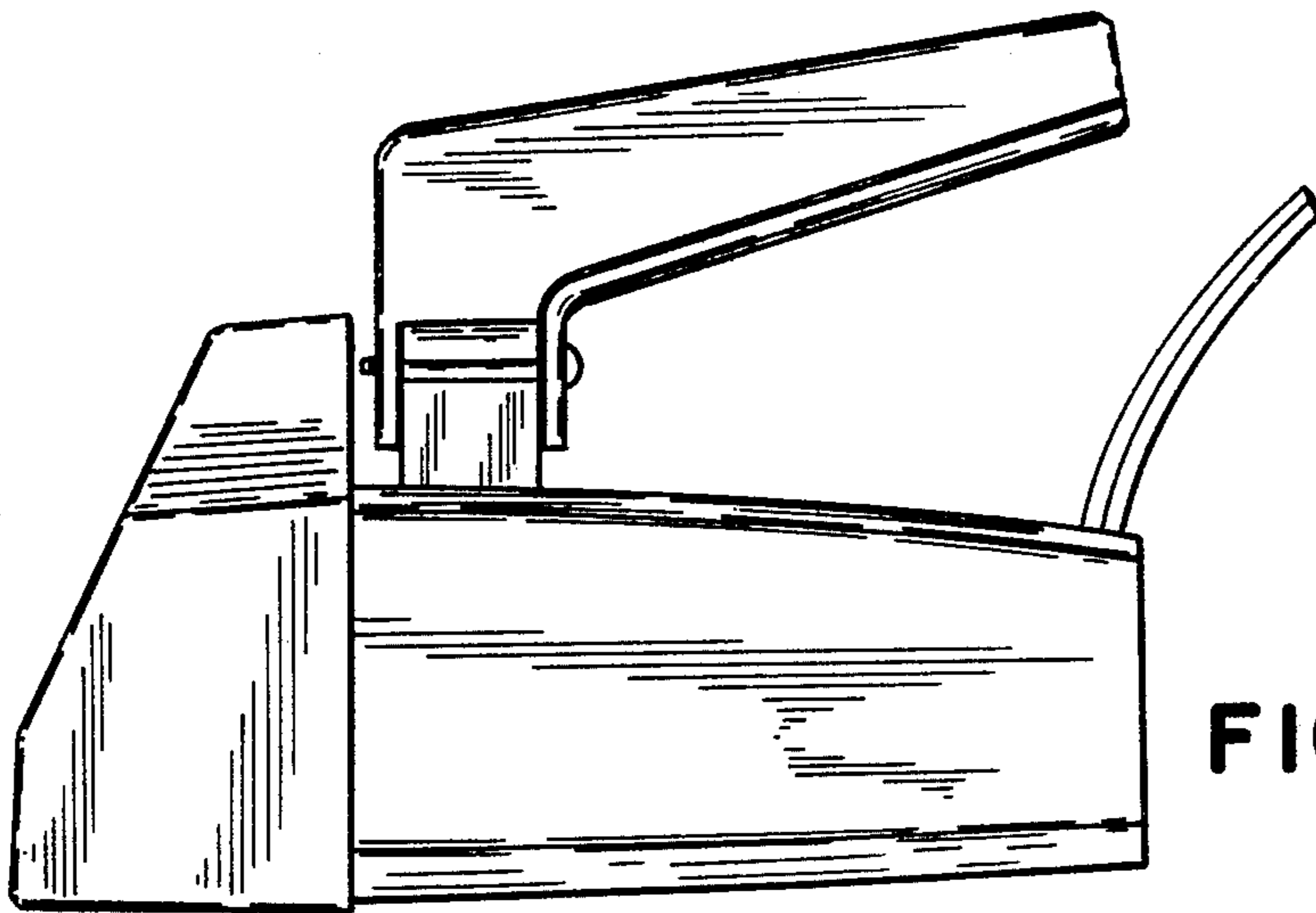

FIG.—3



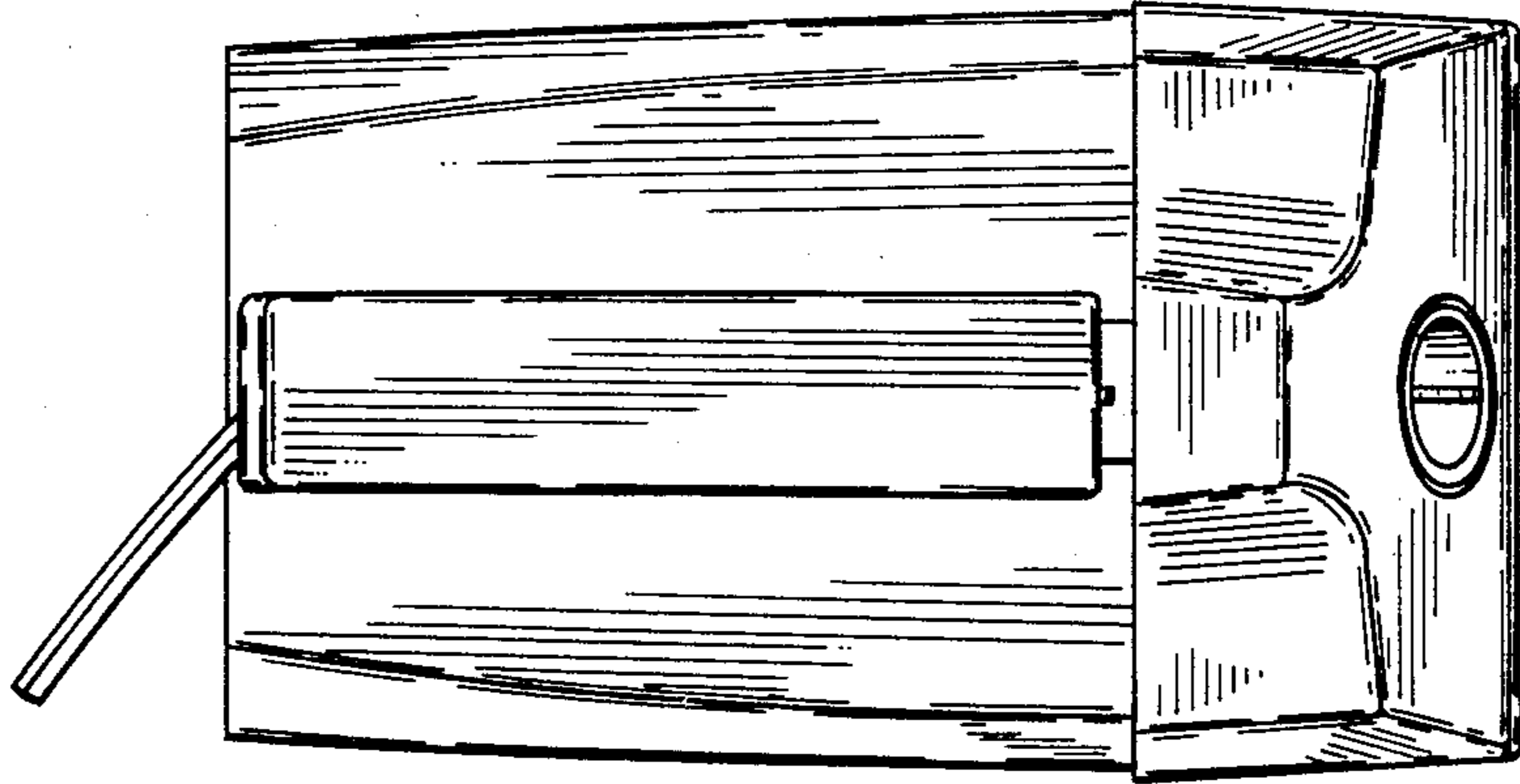

FIG.—4

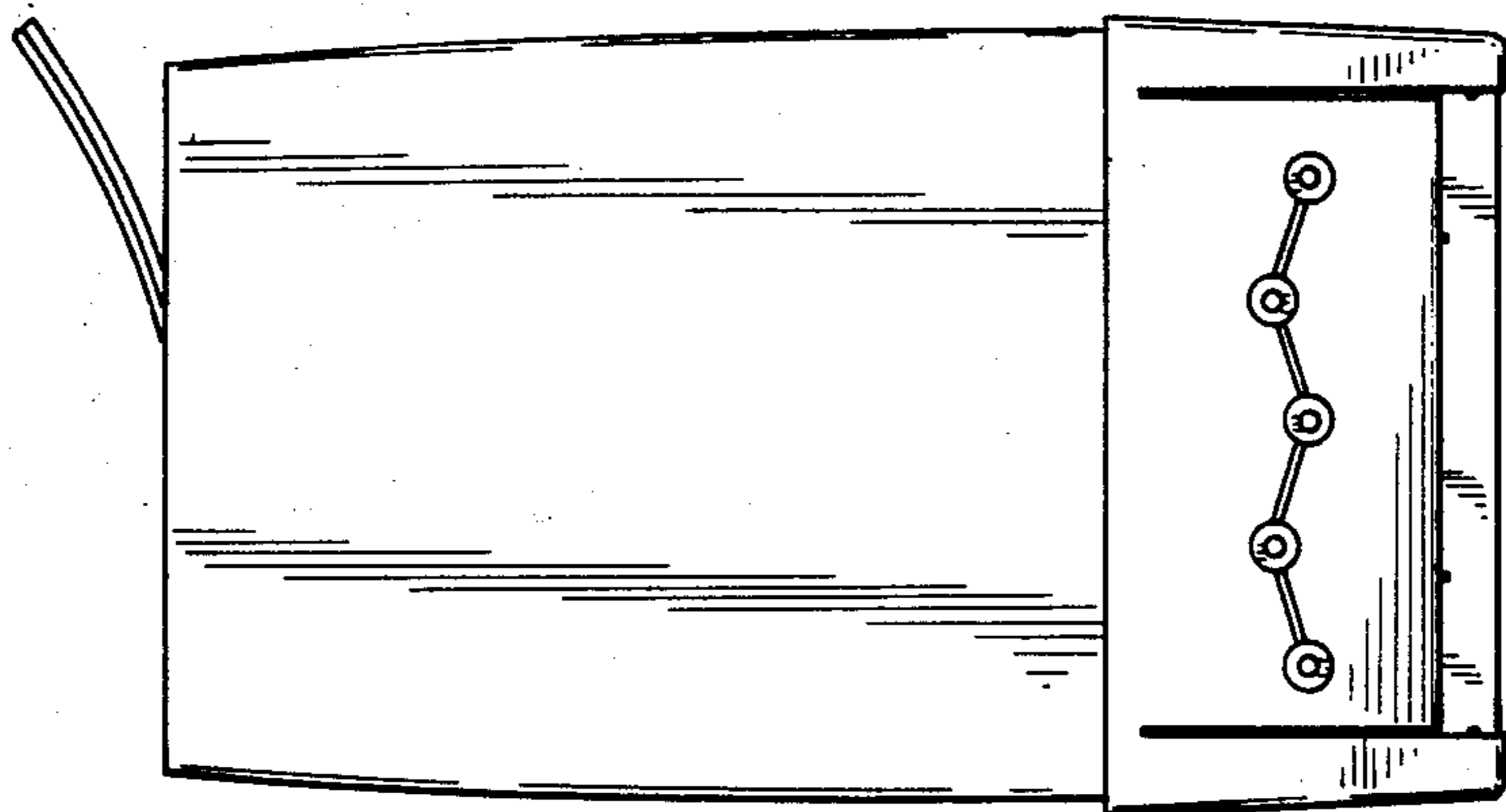

FIG.—5

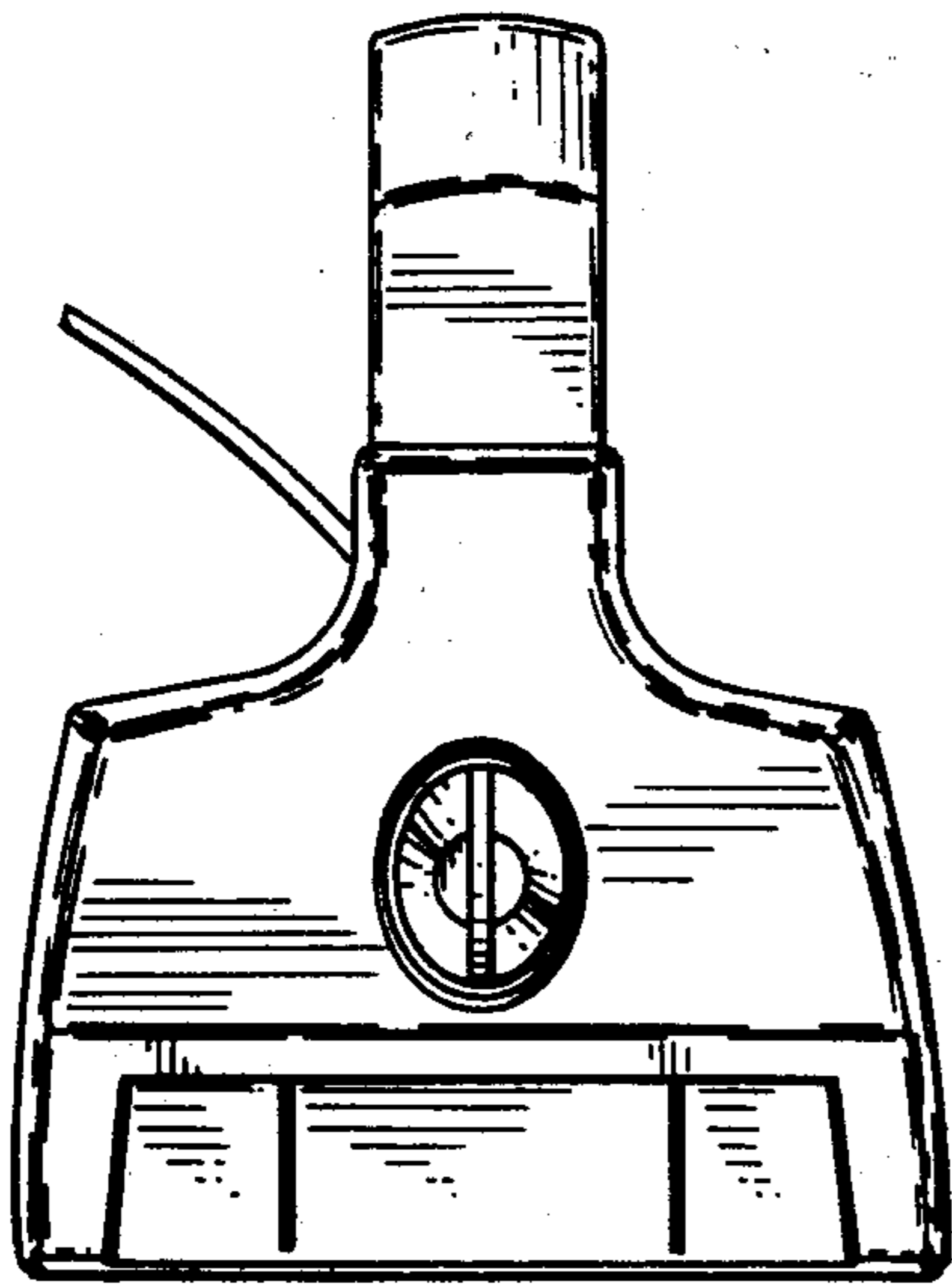

FIG.—6

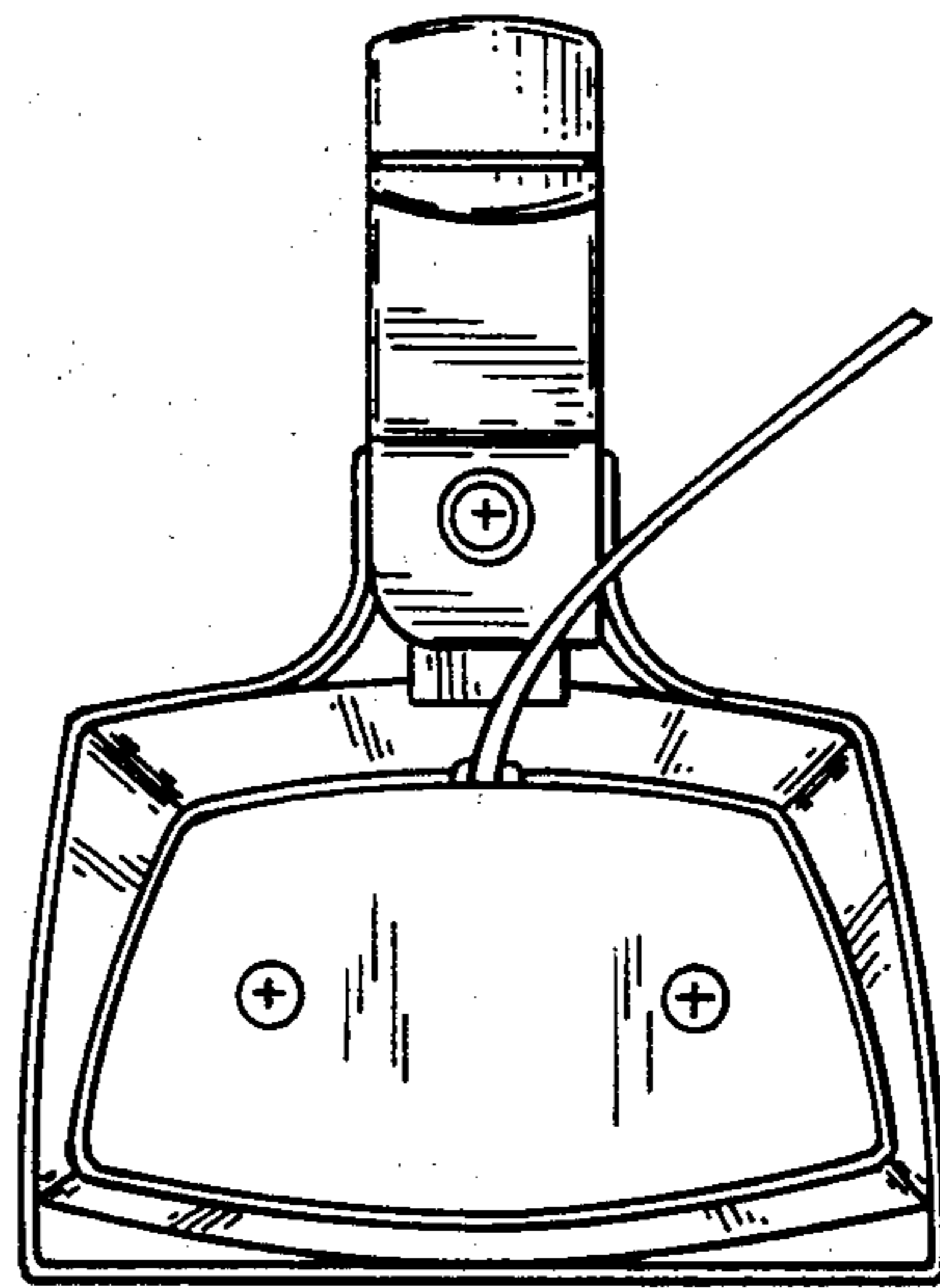

FIG.—7

FIG.—8

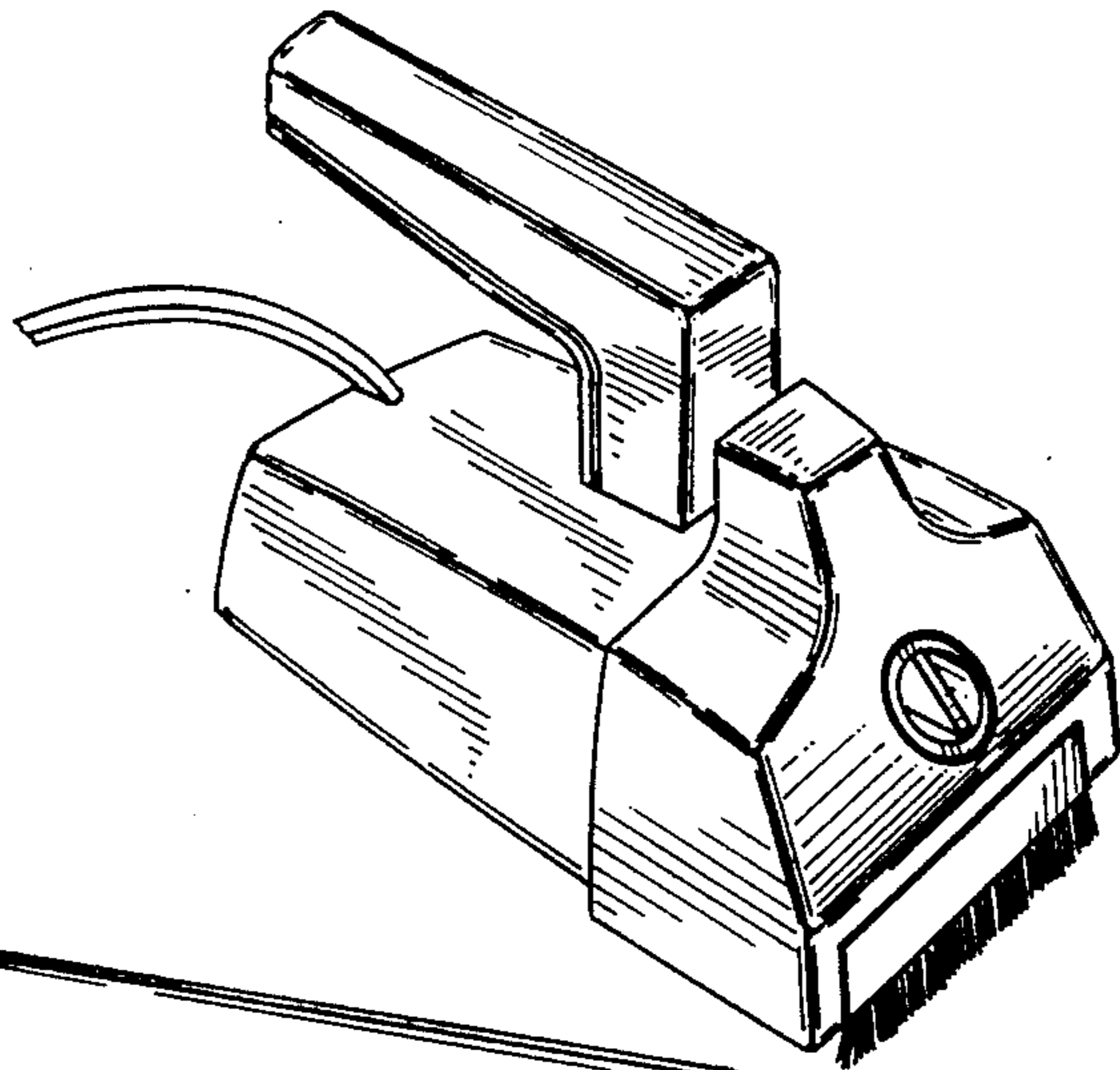

FIG.—9

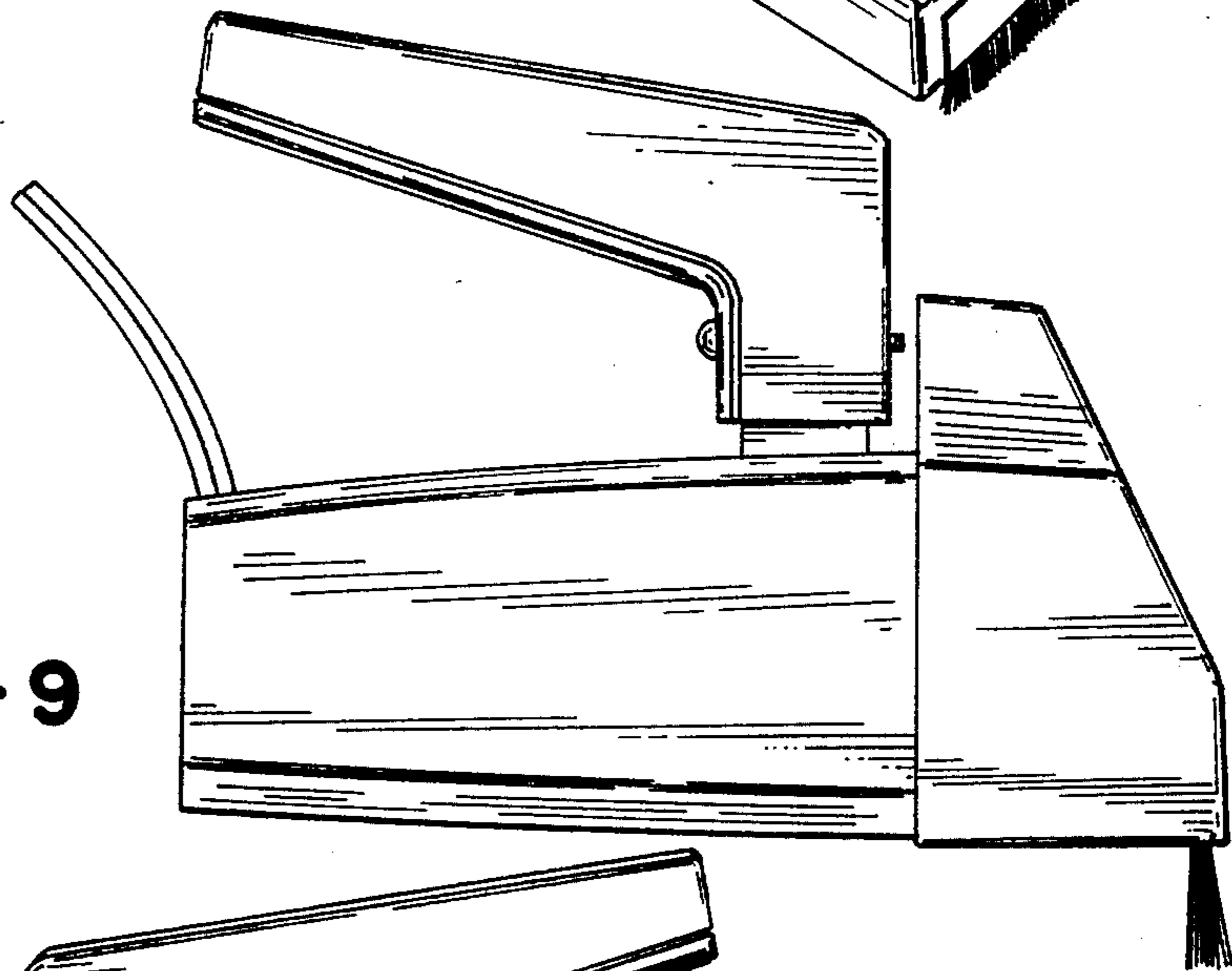
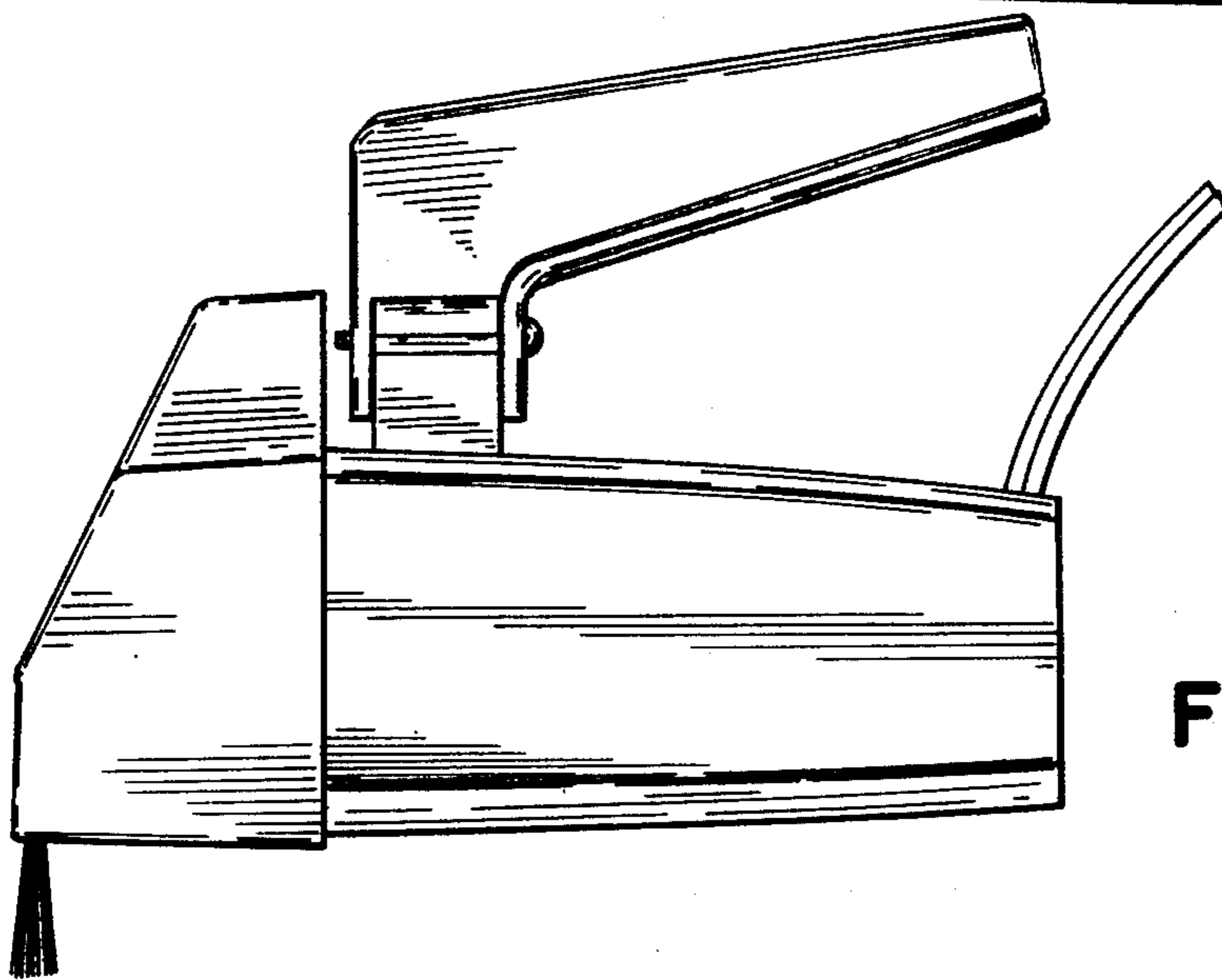

FIG.—10



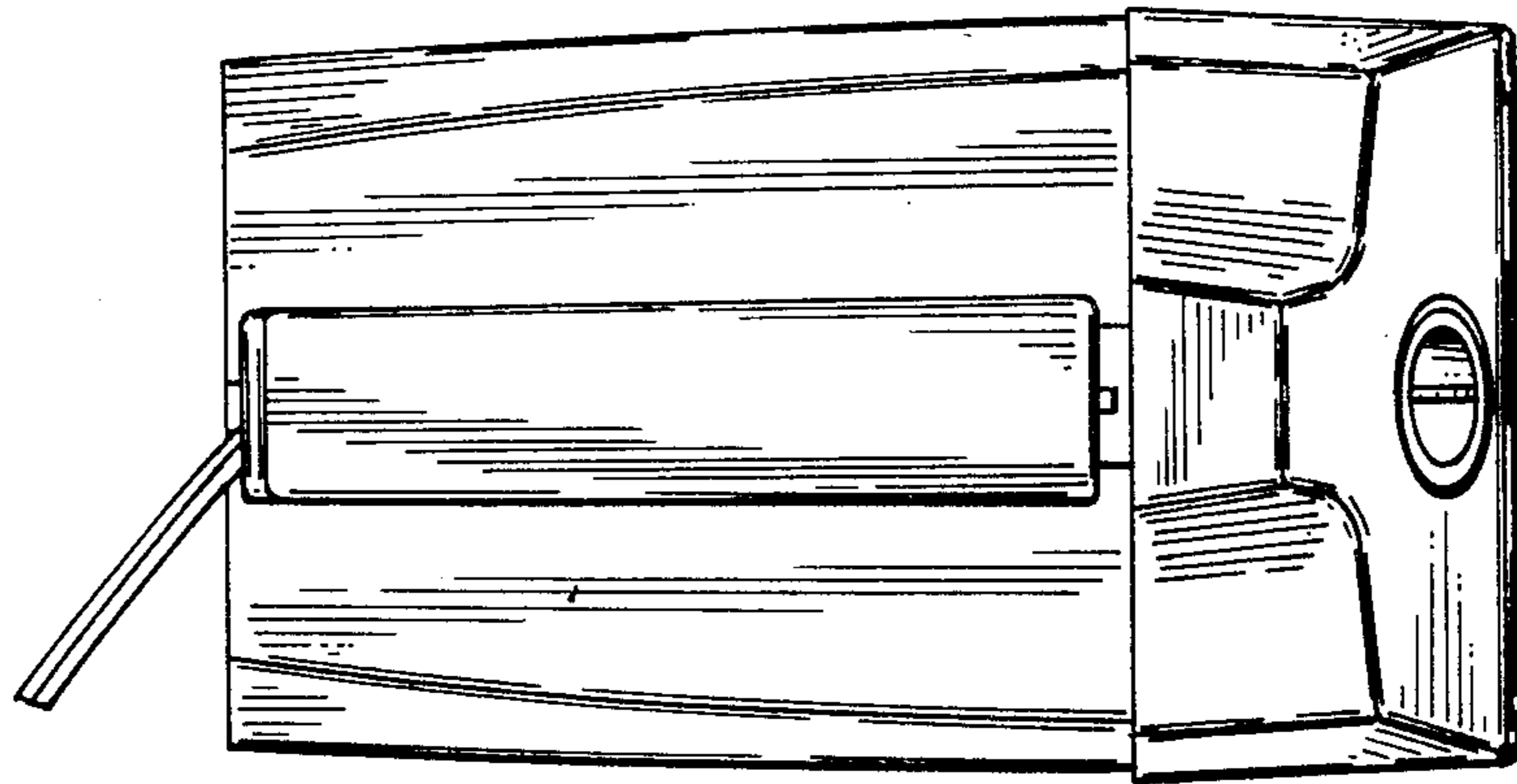

FIG. — 11

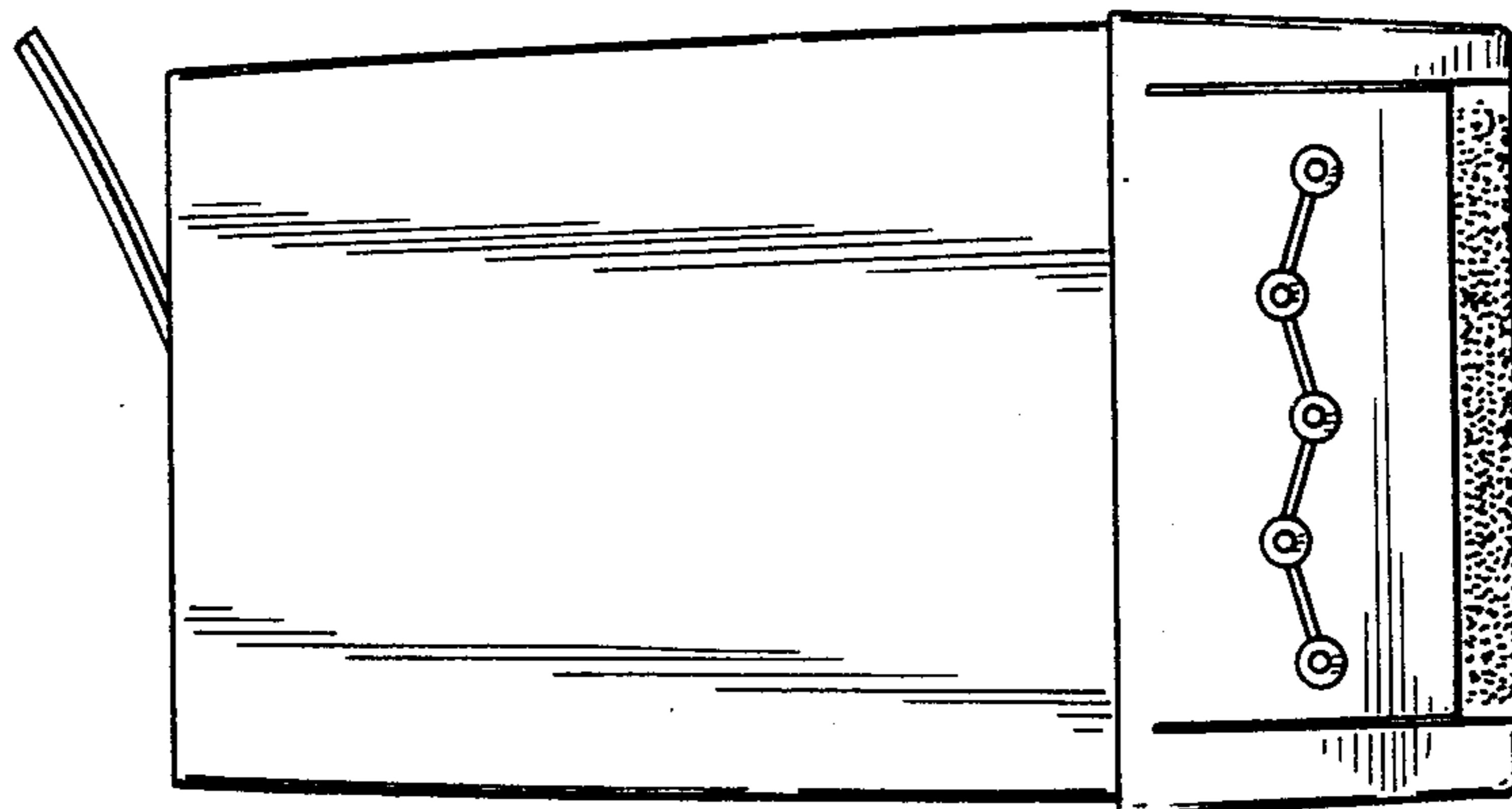

FIG. — 12

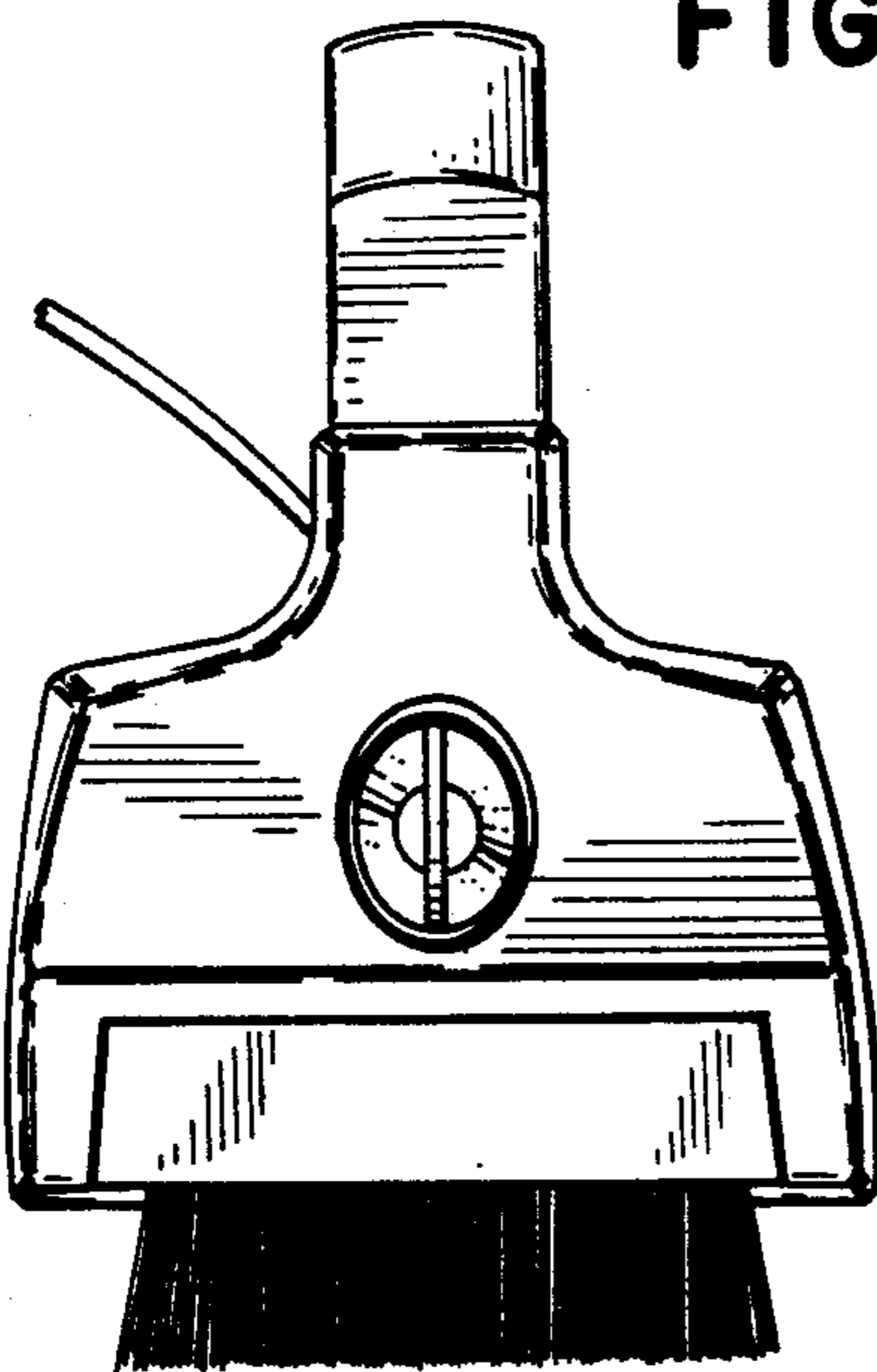

FIG. — 13

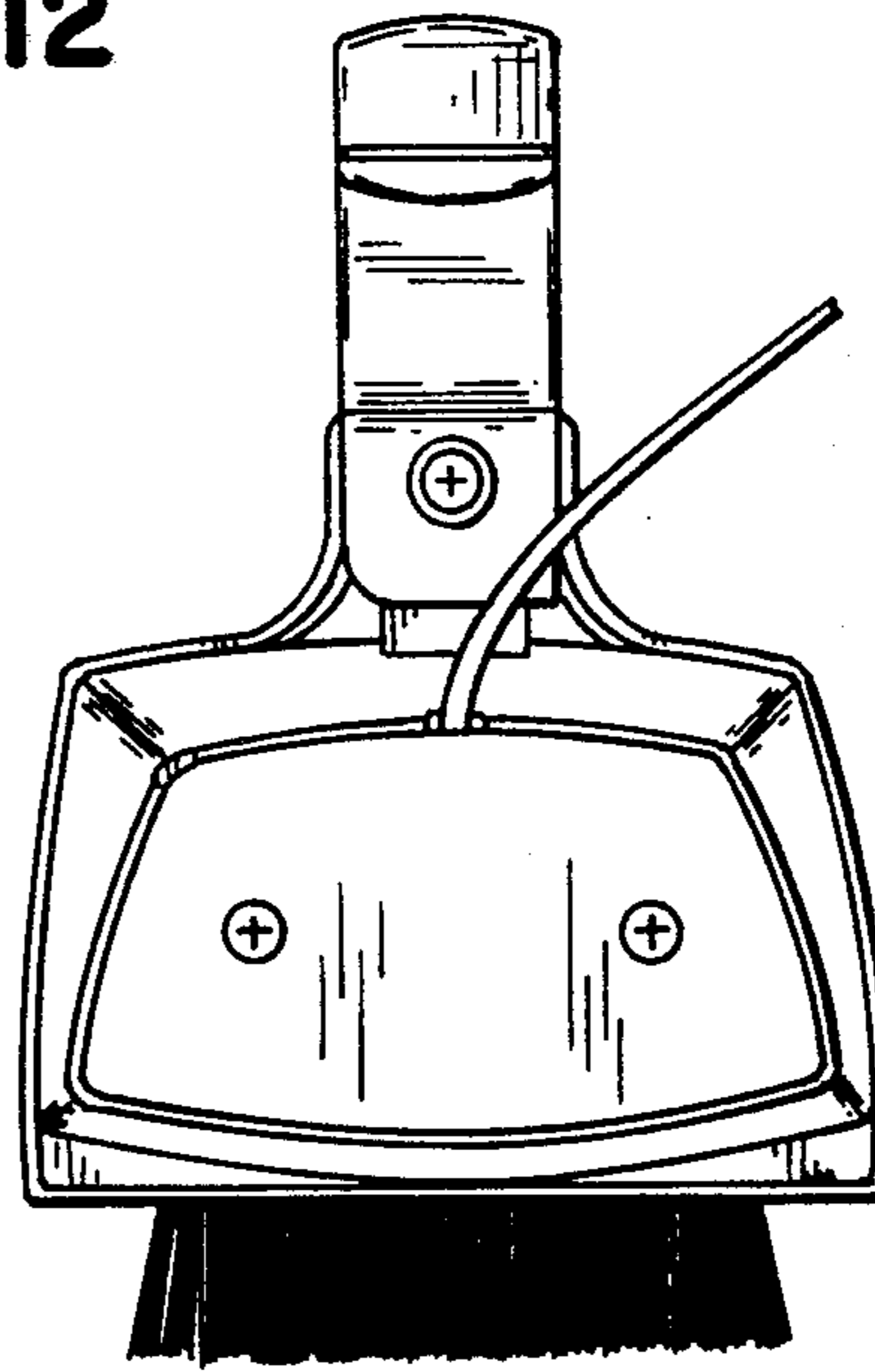

FIG. — 14