

[54] MOTORBOAT

[75] Inventor: Hiroshi Nishida, Hyogo, Japan

[73] Assignee: Kawasaki Jukogyo Kabushiki Kaisha, Kobe, Japan

[**] Term: 14 Years

[21] Appl. No.: 585,168

[22] Filed: Mar. 1, 1984

[52] U.S. Cl. D12/307

[58] Field of Search D12/300, 305, 307, 310, D12/311, 313, 314; 114/270; 440/38, 87, 88, 89

[56] References Cited

U.S. PATENT DOCUMENTS

D. 220,788	5/1971	Piazza	D12/307
D. 226,036	1/1973	Jacobson	D12/307
D. 233,140	10/1974	Tanaka et al.	D12/307
D. 234,421	3/1975	Lapointe et al.	D12/307
D. 237,956	12/1975	Naito et al.	D12/314

D. 241,328	9/1976	Naito et al.	D12/307
D. 260,797	9/1981	Calengor et al.	D21/228
D. 265,820	8/1982	Tomonaga et al.	D12/307
3,826,220	7/1974	Jacobson	114/270

Primary Examiner—James M. Gandy
Assistant Examiner—Kay H. Chin
Attorney, Agent, or Firm—Leydig, Voit & Mayer

[57] CLAIM

The ornamental design for a motorboat, as shown and described.

DESCRIPTION

FIG. 1 is a front elevational view of a motorboat showing my new design;
FIG. 2 is a left side elevational view thereof;
FIG. 3 is a right side elevational view thereof;
FIG. 4 is a top plan view thereof;
FIG. 5 is a rear elevational view thereof;
FIG. 6 is a bottom plan view thereof; and
FIG. 7 is a top perspective view thereof with the hand-lever lifted up.

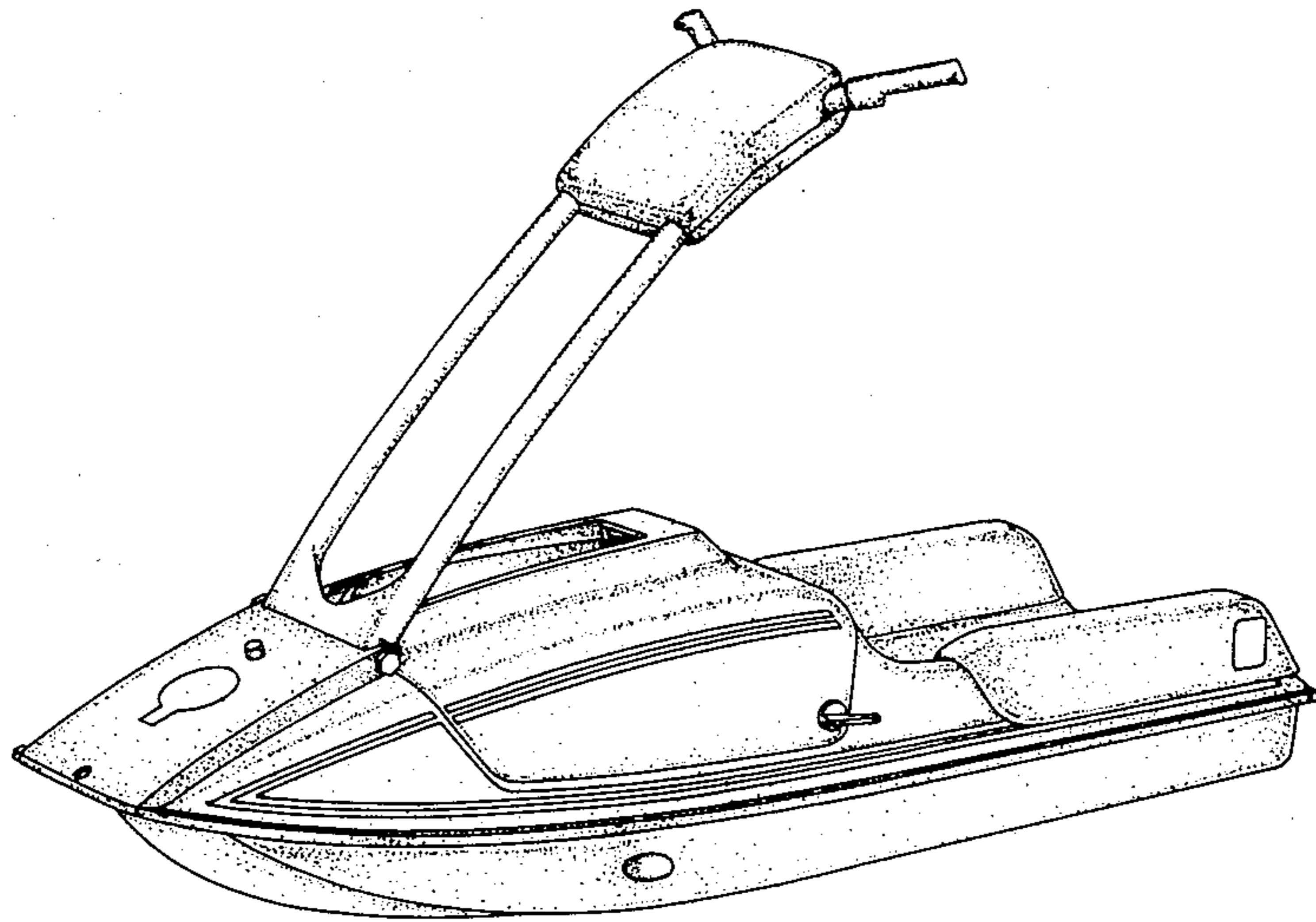

FIG. 1

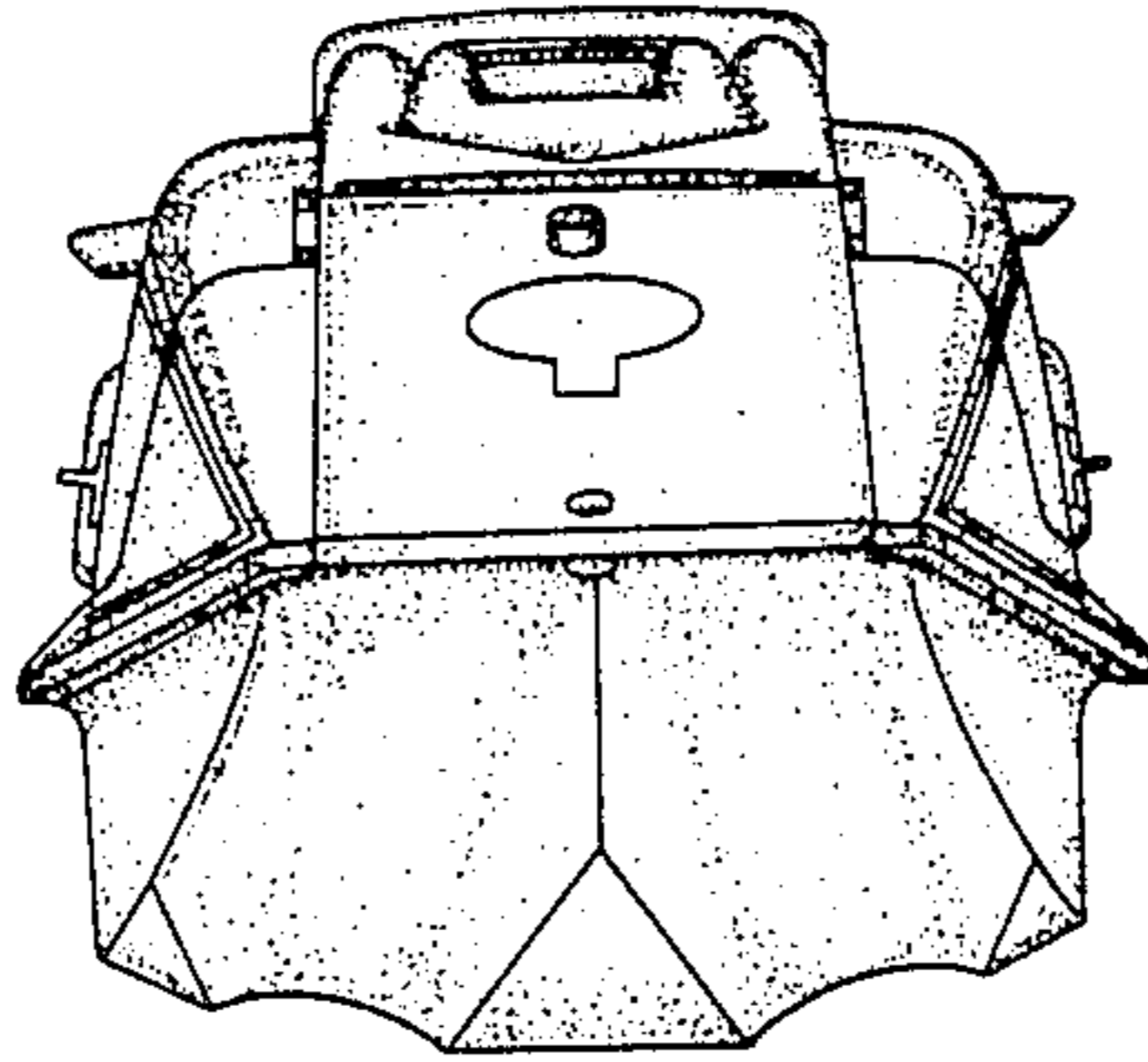

FIG. 2

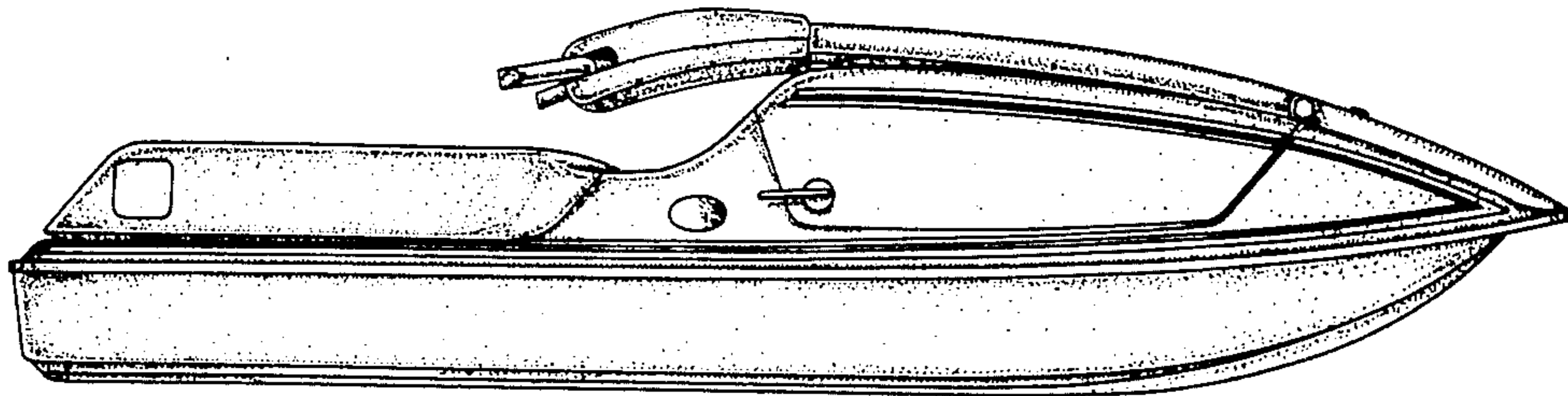

FIG. 3

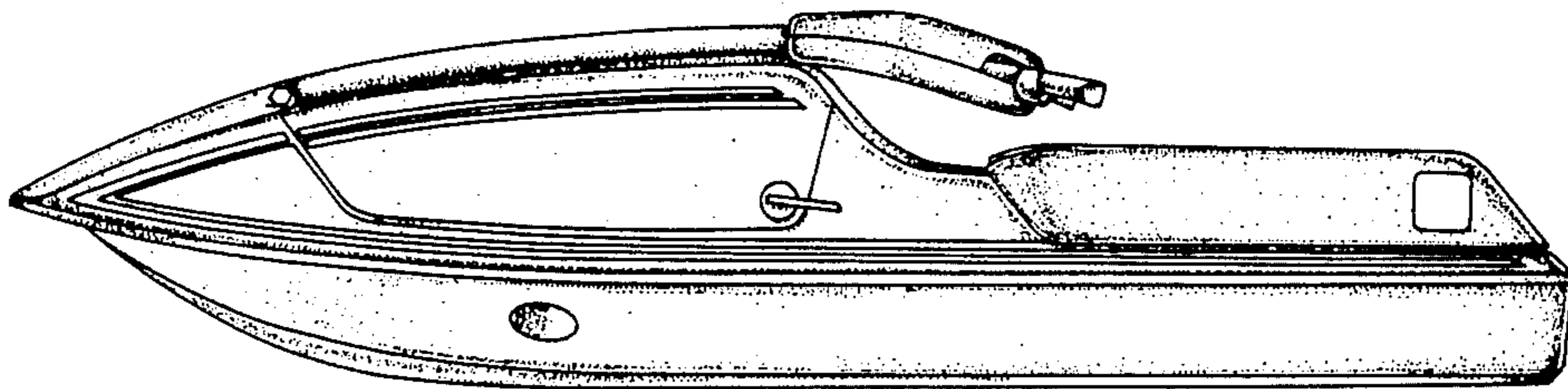

FIG. 4

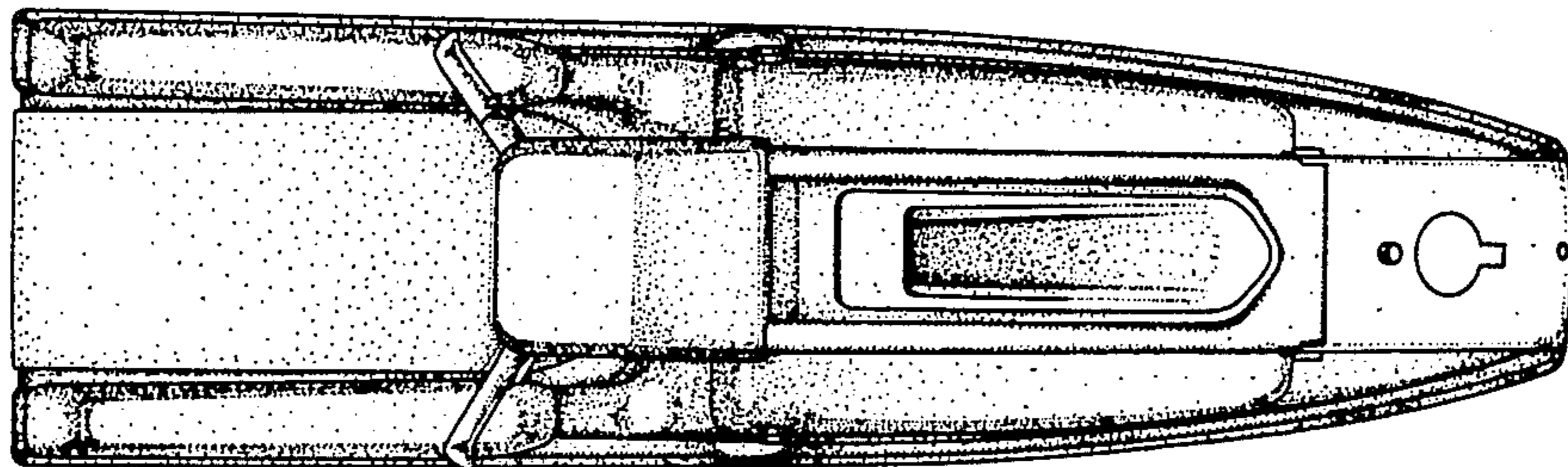

FIG. 5

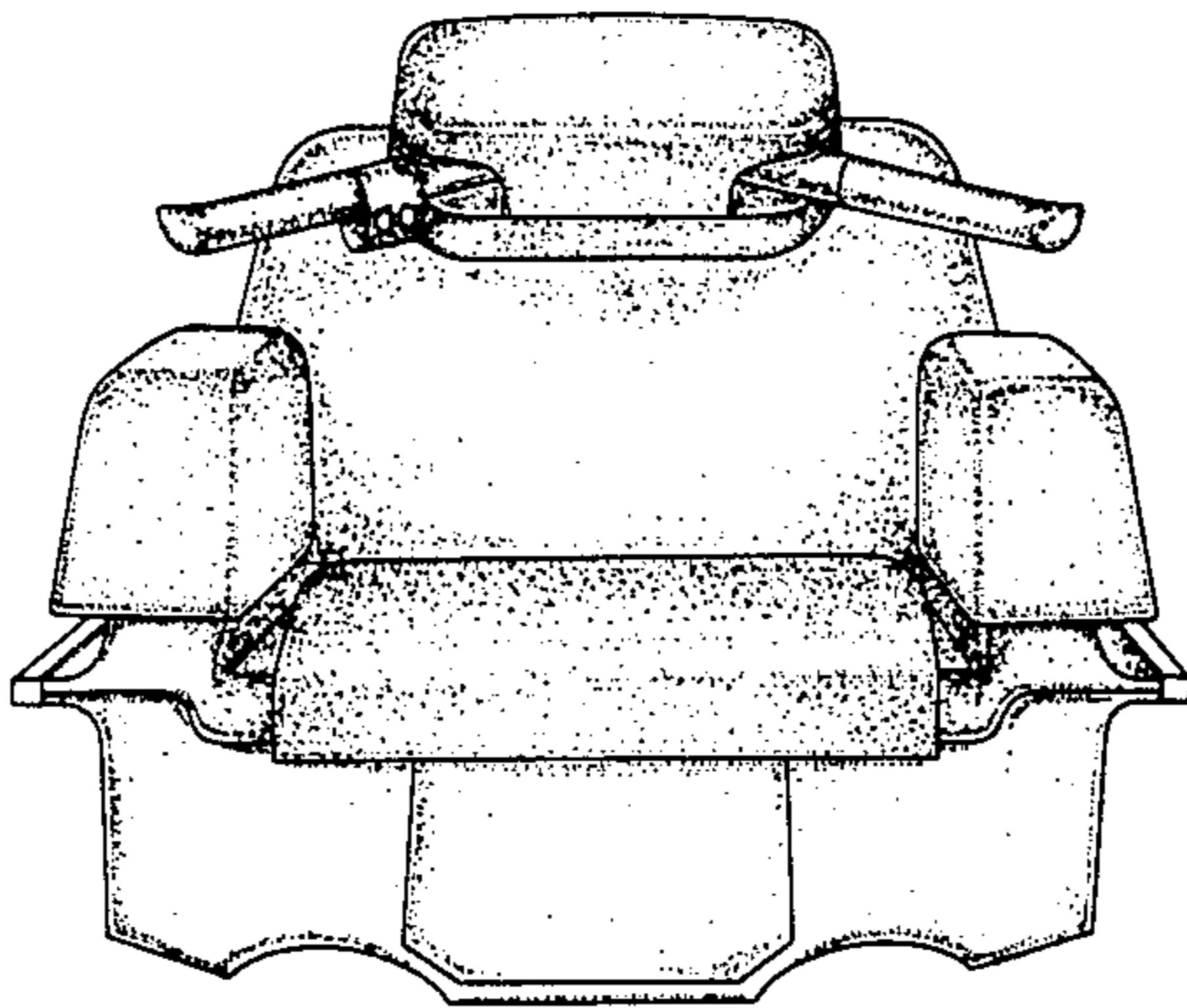

FIG. 6

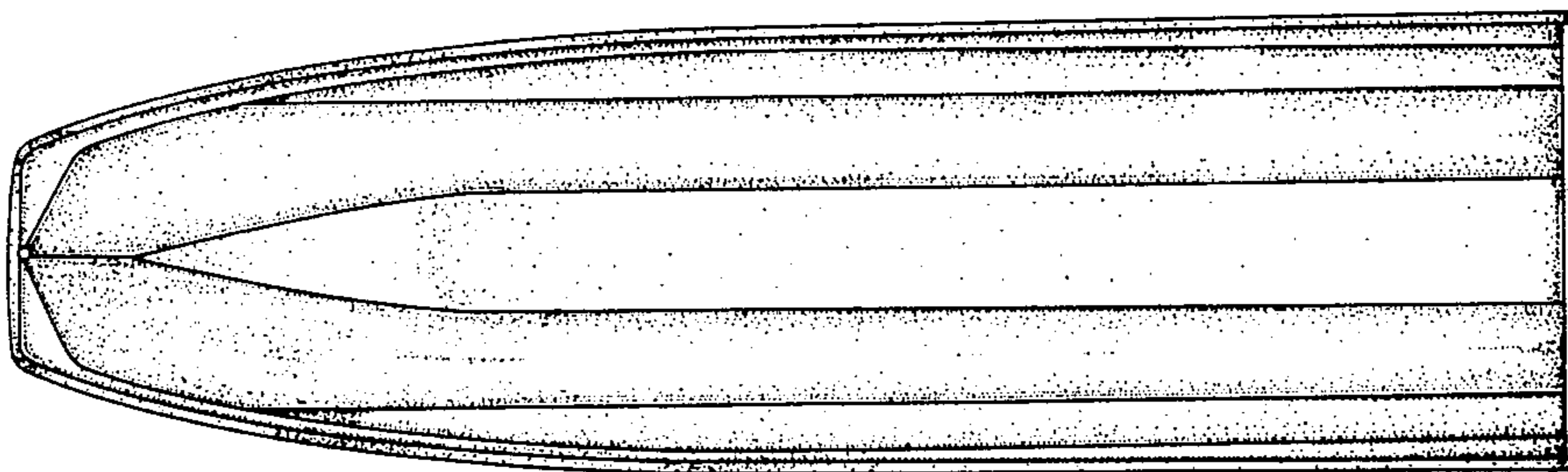

FIG. 7

