

[54] CONTAINER FOR LIQUIDS

- [75] Inventor: Adrien P. Rayner, Iver, England
- [73] Assignee: Metal Box p.l.c., Reading, England
- [**] Term: 14 Years
- [21] Appl. No.: 498,657
- [22] Filed: May 27, 1983
- [52] U.S. Cl. D9/428; D9/349; D9/370
- [58] Field of Search D9/349, 351, 352, 355, D9/428, 454, 390-399, 370; 229/6 R, 1.5 B, 1.5 R, 2.5 R, 4.5; 220/1 R, 1 BC

[56] References Cited

U.S. PATENT DOCUMENTS

D. 219,265	11/1970	Churan	D9/379 X
D. 259,625	6/1981	Hamilton et al.	D9/428
D. 276,139	10/1984	Rayner	D9/428 X
D. 278,800	5/1985	Bowen et al.	D9/352 X

Primary Examiner—Robert C. Spangler
Attorney, Agent, or Firm—Diller, Ramik & Wright

[57] CLAIM

The ornamental design for a container for liquids, substantially as shown and described.

DESCRIPTION

FIG. 1 is an elevational view of a container for liquids showing my new design, the opposite side being the same in appearance;
 FIG. 2 is an elevational view looking from the right of FIG. 1, the opposite side being the same in appearance;
 FIG. 3 is a vertical sectional view taken on the line 3—3 of FIG. 4;
 FIG. 4 is a top plan view;
 FIG. 5 is a bottom plan view;
 FIG. 6 is a fragmentary, enlarged sectional view taken on the line 6—6 of FIG. 4; and
 FIG. 7 is a fragmentary, enlarged sectional view taken on the line 7—7 of FIG. 4.

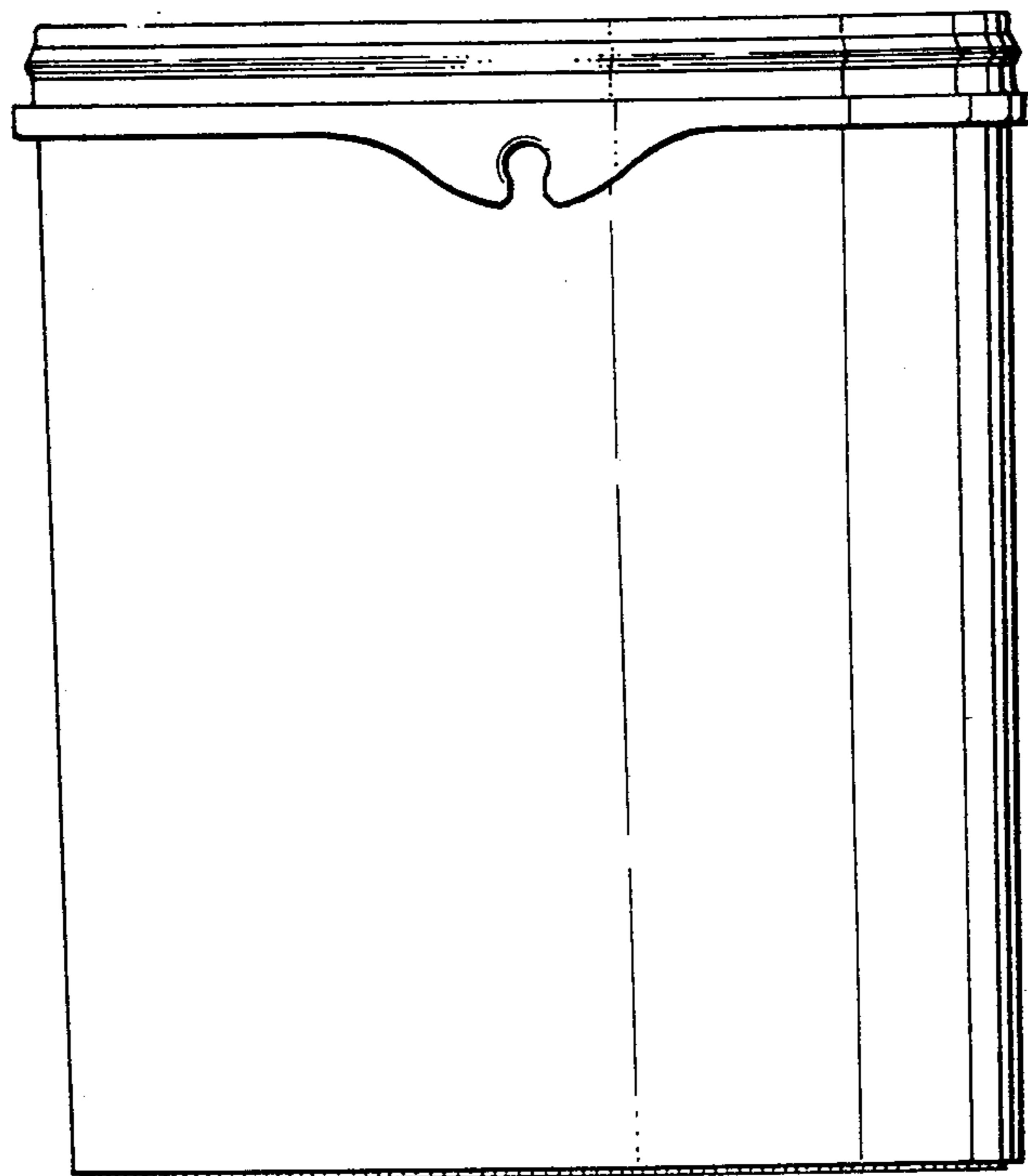

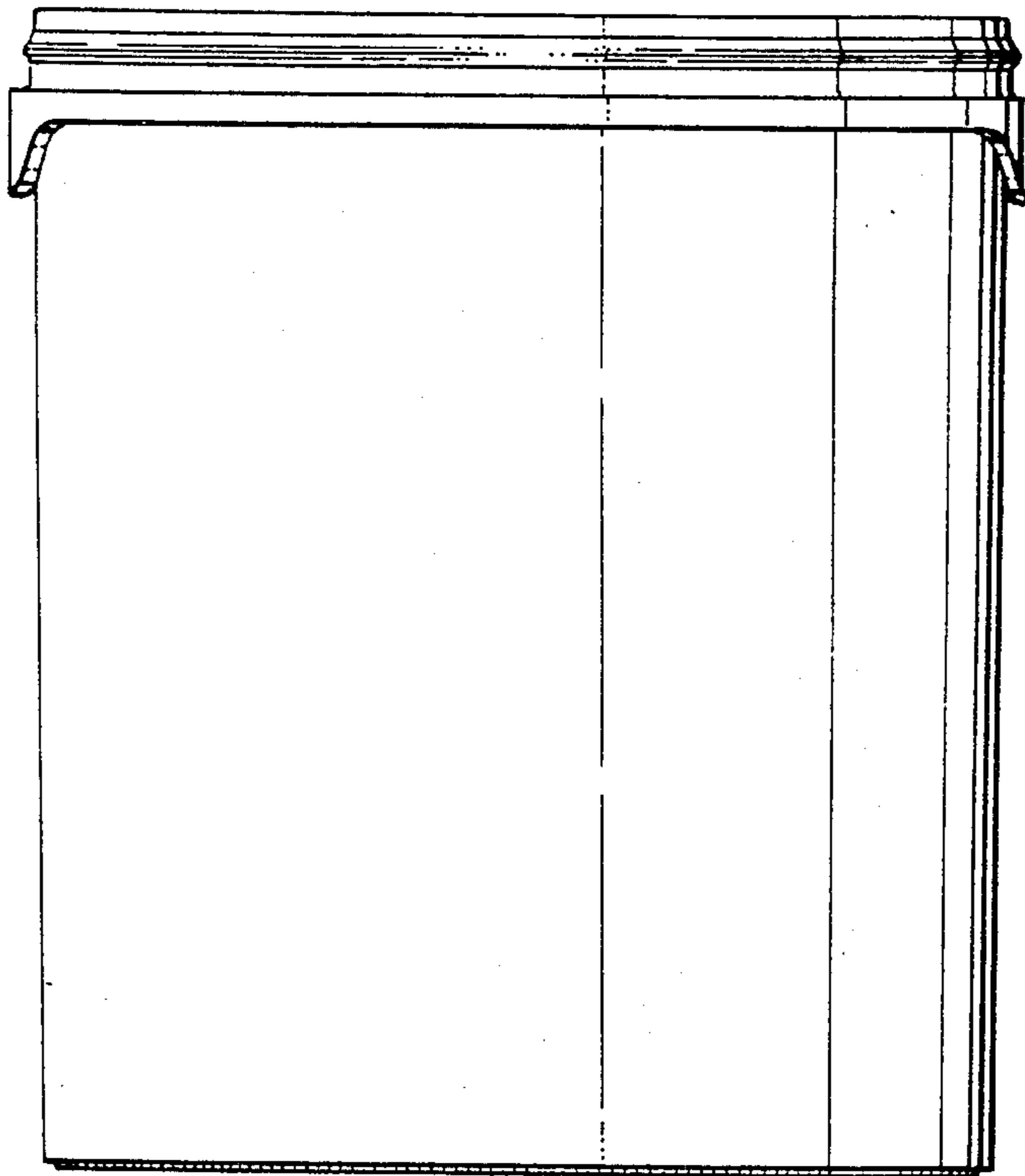

FIG. 1

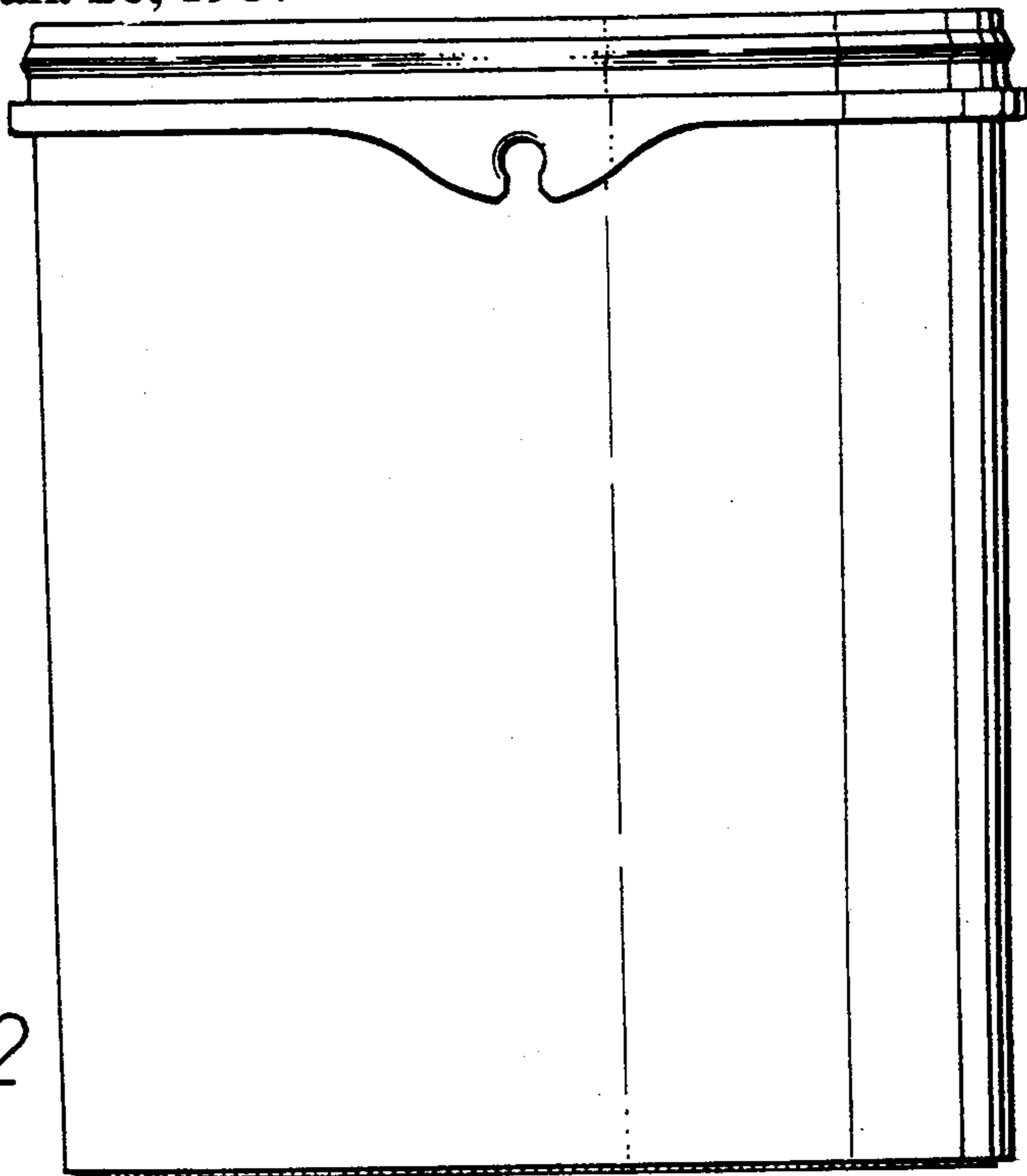

FIG. 2

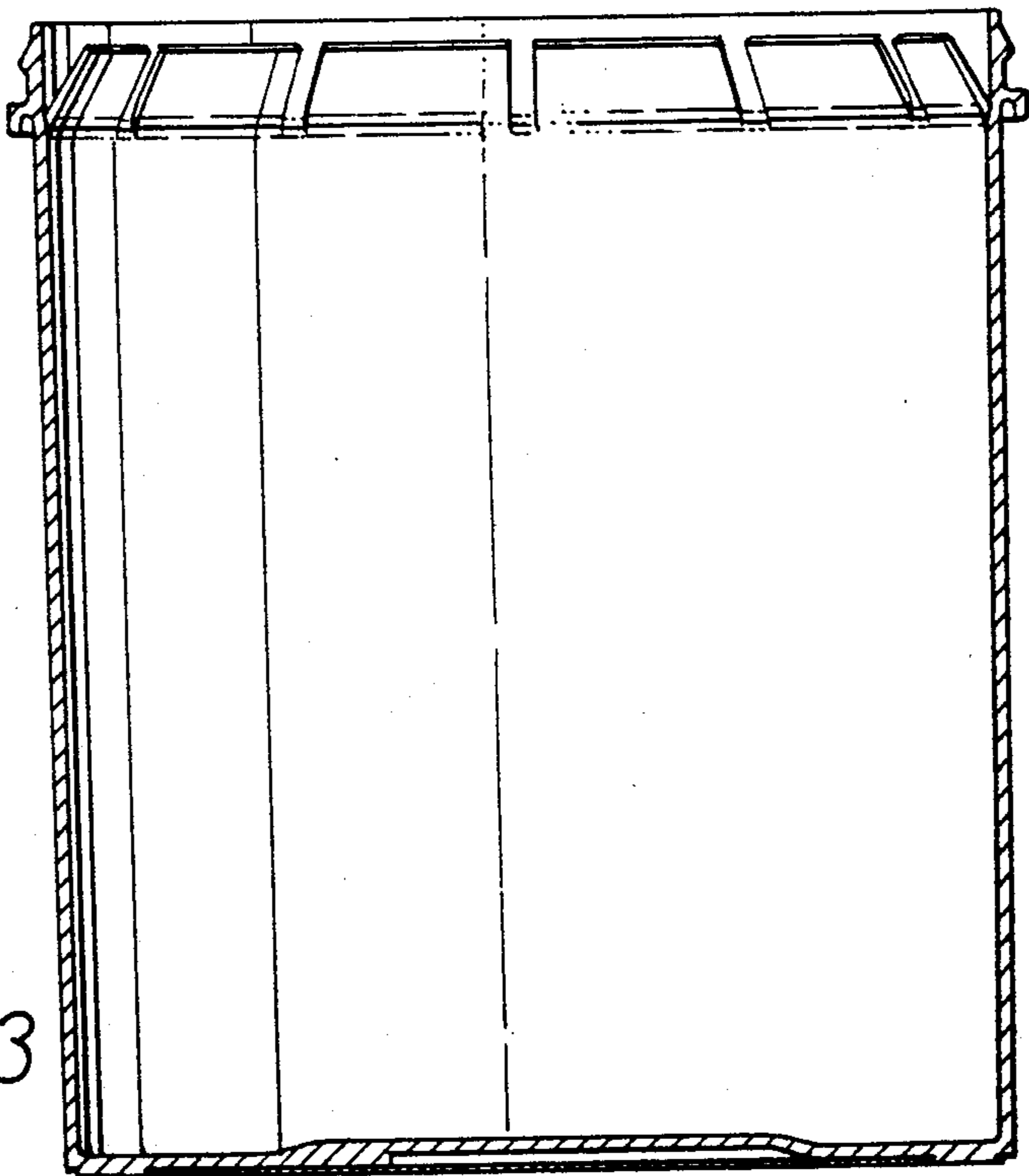

FIG. 3

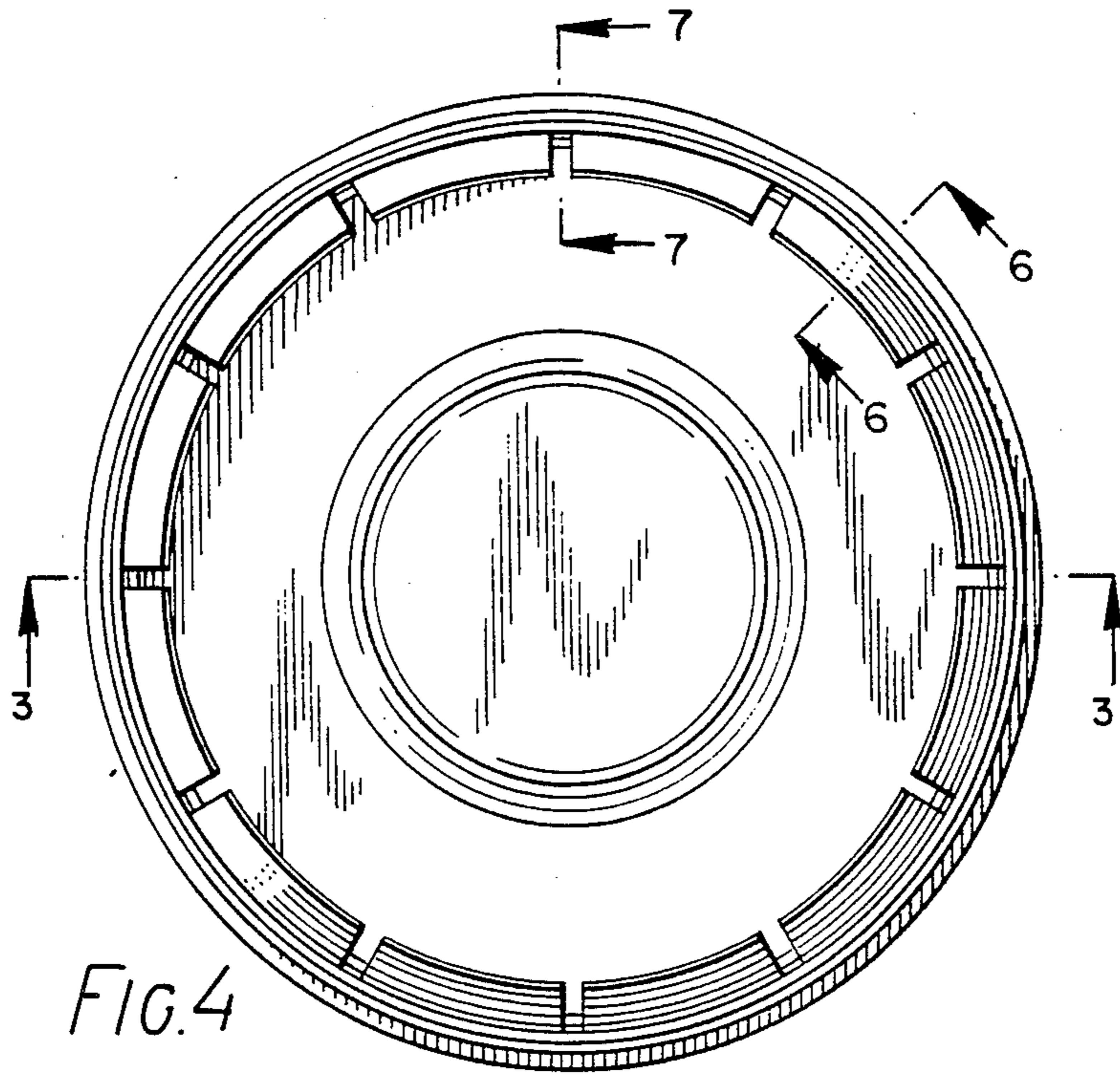

FIG. 4

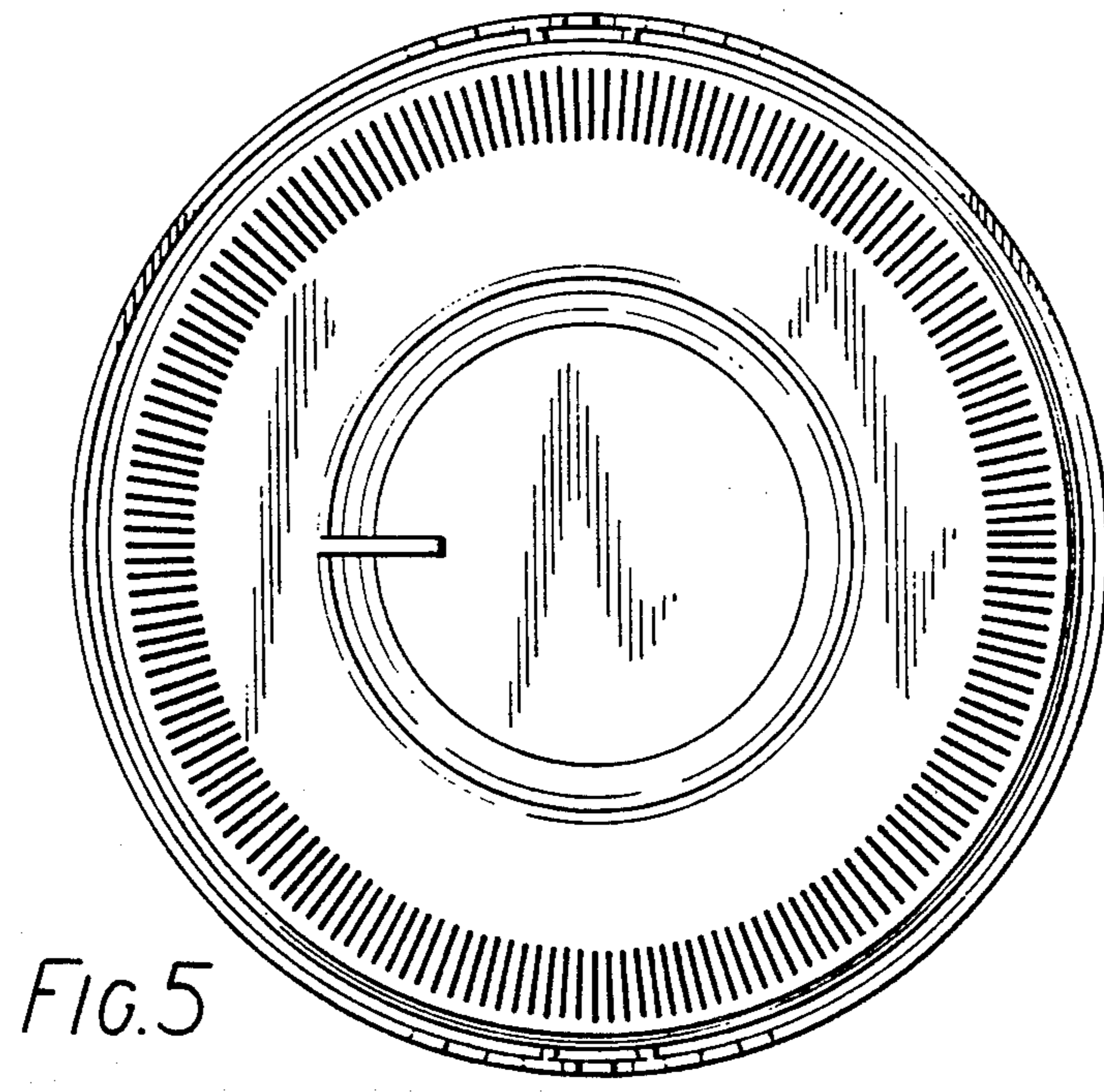

FIG. 5

FIG. 6

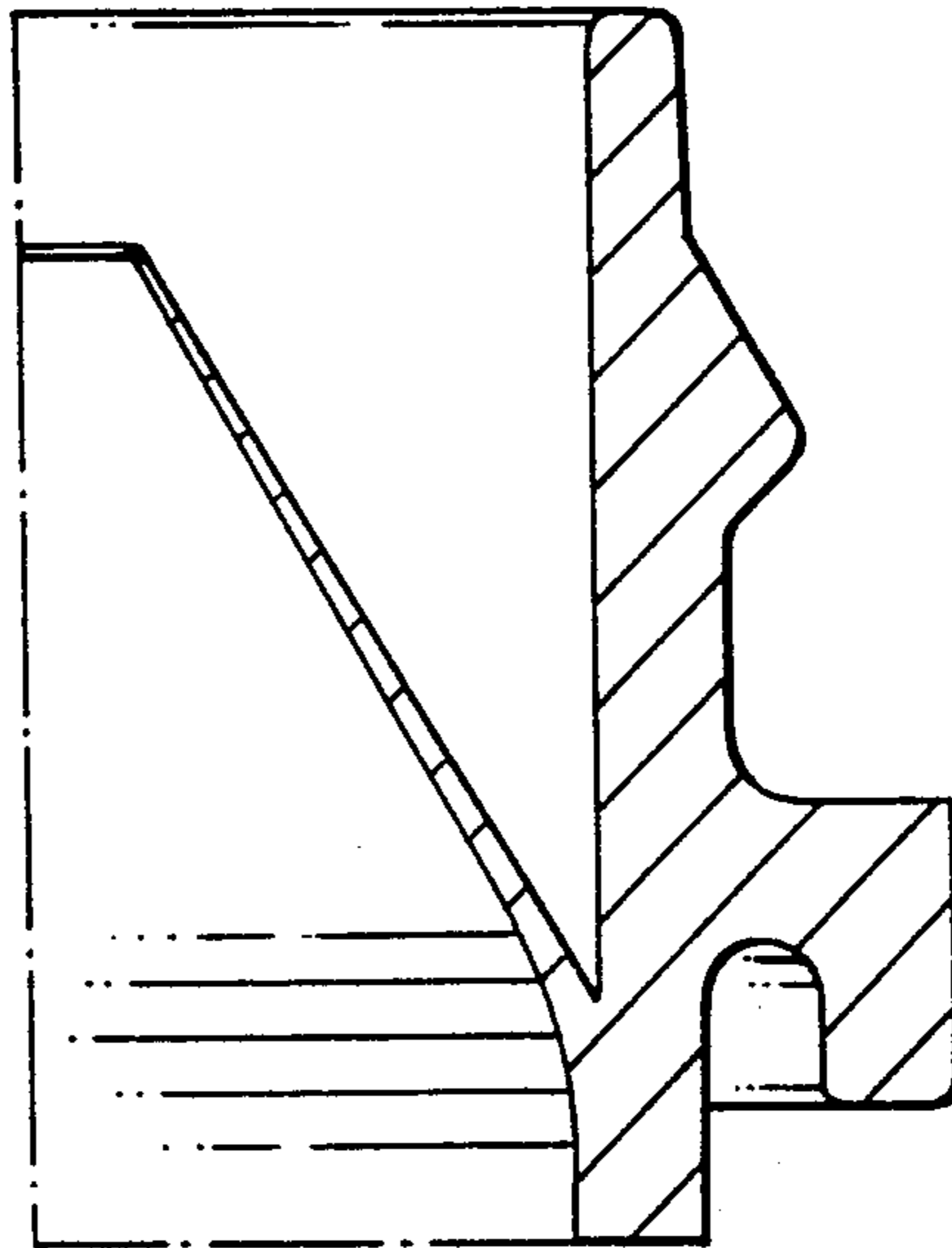

FIG. 7

