

[54] **BASE FOR KITCHEN APPLIANCE**
 [75] **Inventor: Robert Osit, Annapolis, Md.**
 [73] **Assignee: Black & Decker, Inc., Newark, Del.**
 [**] **Term: 14 Years**
 [21] **Appl. No.: 652,059**
 [22] **Filed: Sep. 19, 1984**
 [52] **U.S. Cl. D7/412; D7/376;
 D7/379**
 [58] **Field of Search D7/376-379,
 D7/381-384, 386, 412; D19/53; D24/41;
 D28/58; D32/17; 4/446; 15/3.15, 3.53, 22 R;
 128/49; 173/163; 312/280; 320/2; 366/129,
 342-344; 416/122; 433/131; 446/138**

[56] **References Cited**

U.S. PATENT DOCUMENTS

D. 147,207	7/1947	Preble, Jr.	D7/379
D. 161,454	1/1951	Iannelli	D7/379
D. 162,833	4/1951	Iannelli	D7/379
D. 165,747	1/1952	Gemmill	D7/379
D. 174,161	3/1955	Corbett	D7/379
D. 175,263	8/1955	Lambert	D7/379
D. 186,922	12/1959	Streich et al.	D19/53
D. 197,571	2/1964	Staeger	D7/386
D. 200,686	3/1965	Hauptli	D7/386
D. 219,110	11/1970	Stut	D7/379
D. 236,286	8/1975	McNair	D24/41
D. 256,171	7/1980	Tomaro	D28/58
D. 262,257	12/1981	Sohn	D32/17
D. 263,671	4/1982	Chan	D7/379
D. 278,506	4/1985	Kafka	D7/379 X
D. 279,072	6/1985	Elkerbout	D7/386
D. 279,855	7/1985	Elkerbaut	D7/376
873,123	12/1907	Gardy	128/49
1,091,585	3/1914	Motter	15/3.15

1,407,789	2/1922	Erhardt	366/344
2,483,727	10/1949	Frisbie	173/163
2,525,338	10/1950	Brown et al.	416/122
2,632,635	3/1953	Van Guilder	366/129
3,183,891	5/1965	MacDonald	15/3.53
3,224,142	12/1965	Pawelka et al.	446/138
3,466,687	9/1969	Pasculli	15/3.53
3,774,255	11/1973	Pao	4/446
4,050,003	9/1977	Owings et al.	320/2
4,050,528	9/1977	Foltz et al.	173/163
4,137,588	2/1979	Sandt et al.	15/22 R
4,334,724	6/1982	Rogers, Sr.	312/280
4,355,977	10/1982	Ota et al.	433/131
4,530,606	7/1985	Hopkins et al.	366/129

FOREIGN PATENT DOCUMENTS

950531	7/1974	Canada .
1126082	3/1962	Fed. Rep. of Germany .
3306989	8/1984	Fed. Rep. of Germany .
3307023	8/1984	Fed. Rep. of Germany .
3308134	9/1984	Fed. Rep. of Germany .

Primary Examiner—Bernard Ansher
Assistant Examiner—Linda Titolo
Attorney, Agent, or Firm—Paul J. Lerner

[57] **CLAIM**

The ornamental design for a base for kitchen appliance, as shown and described.

DESCRIPTION

FIG. 1 is a top front and left side perspective view of a base for kitchen appliance, showing my new design; FIG. 2 is a top perspective view thereof; FIG. 3 is a front elevational view thereof; FIG. 4 is a rear elevational view thereof; FIG. 5 is a left side elevational view thereof; FIG. 6 is a right side elevational view thereof; FIG. 7 is a top plan view thereof; and FIG. 8 is a bottom plan view thereof.

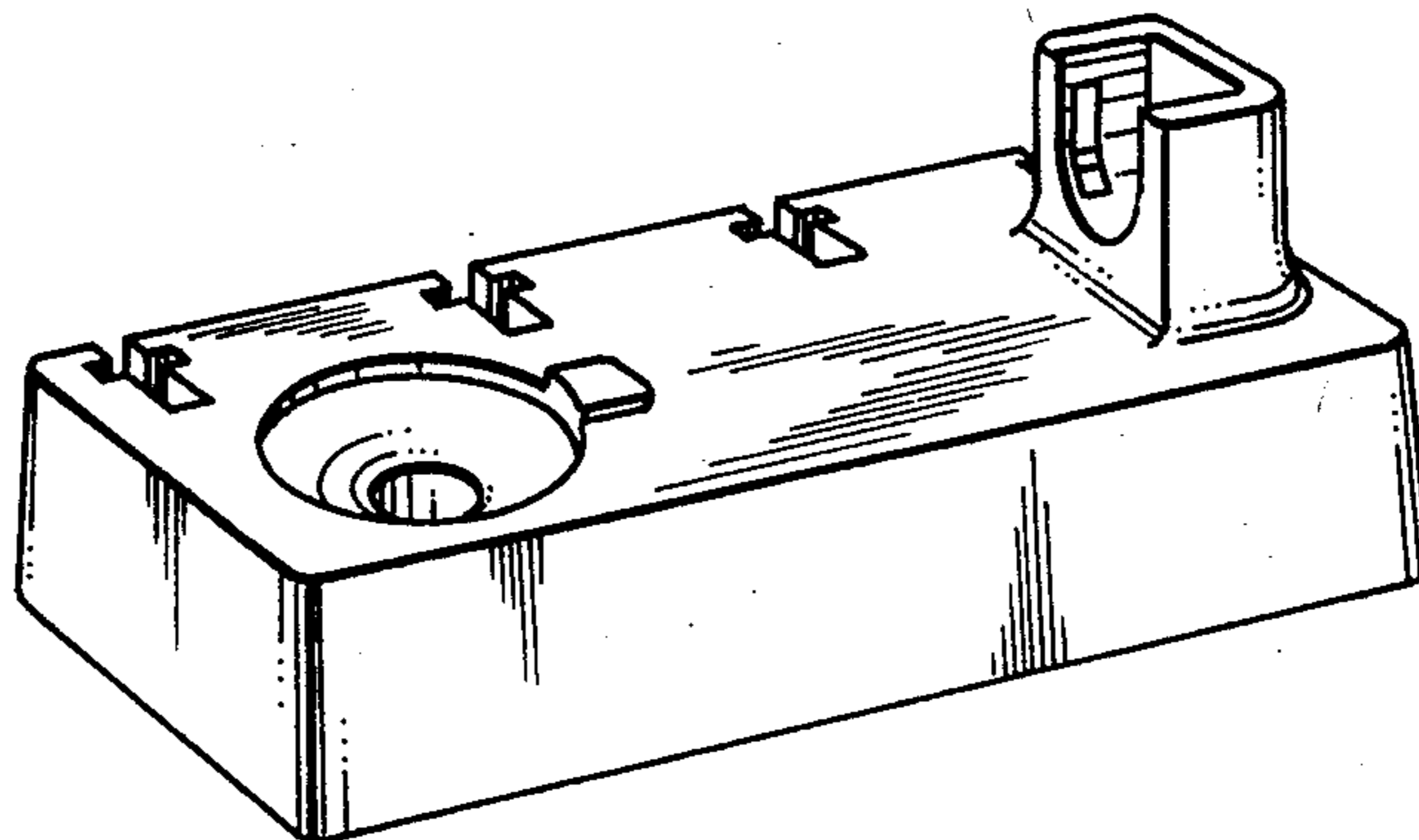

FIG. 1.

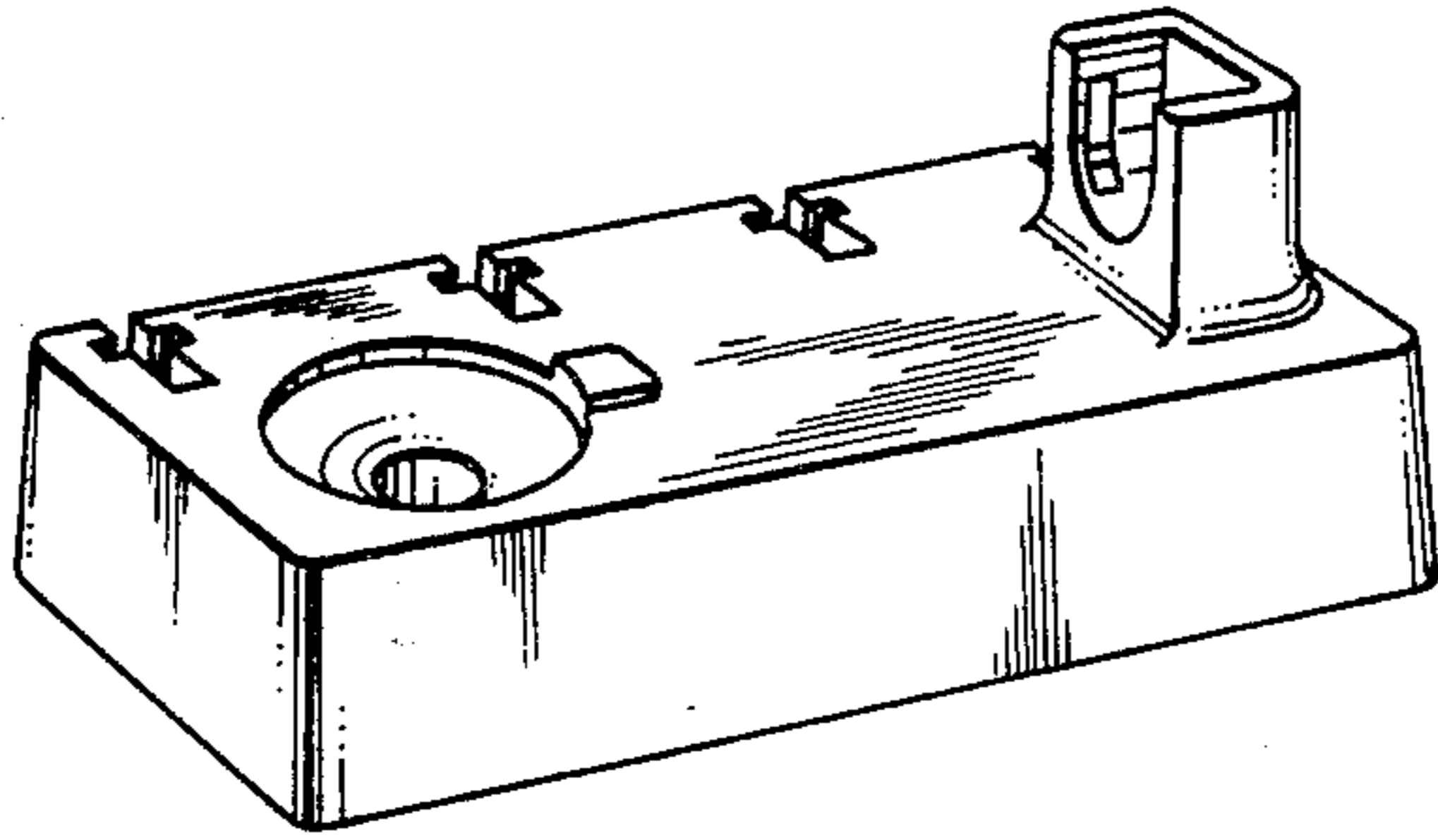

FIG. 2.

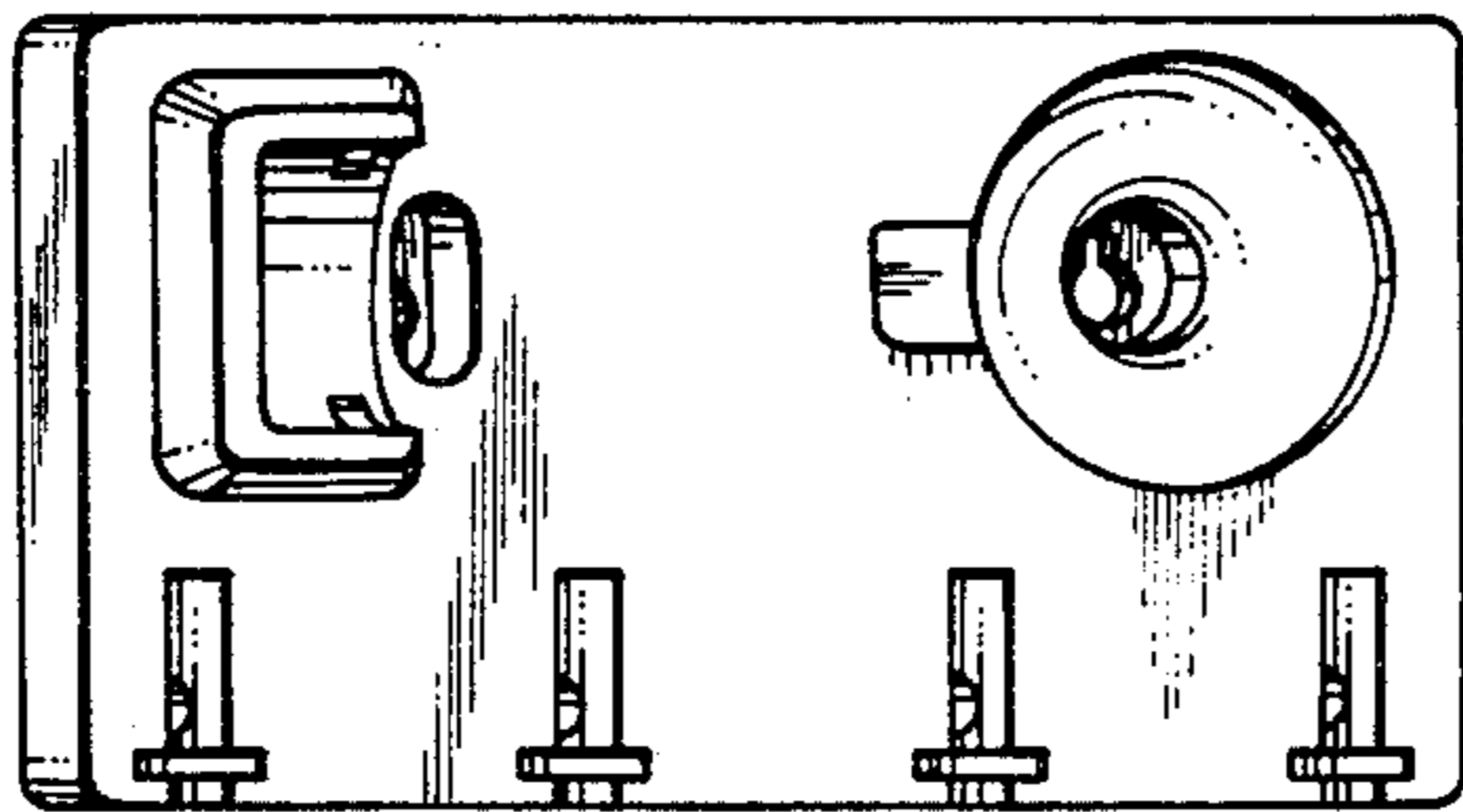

FIG. 3.

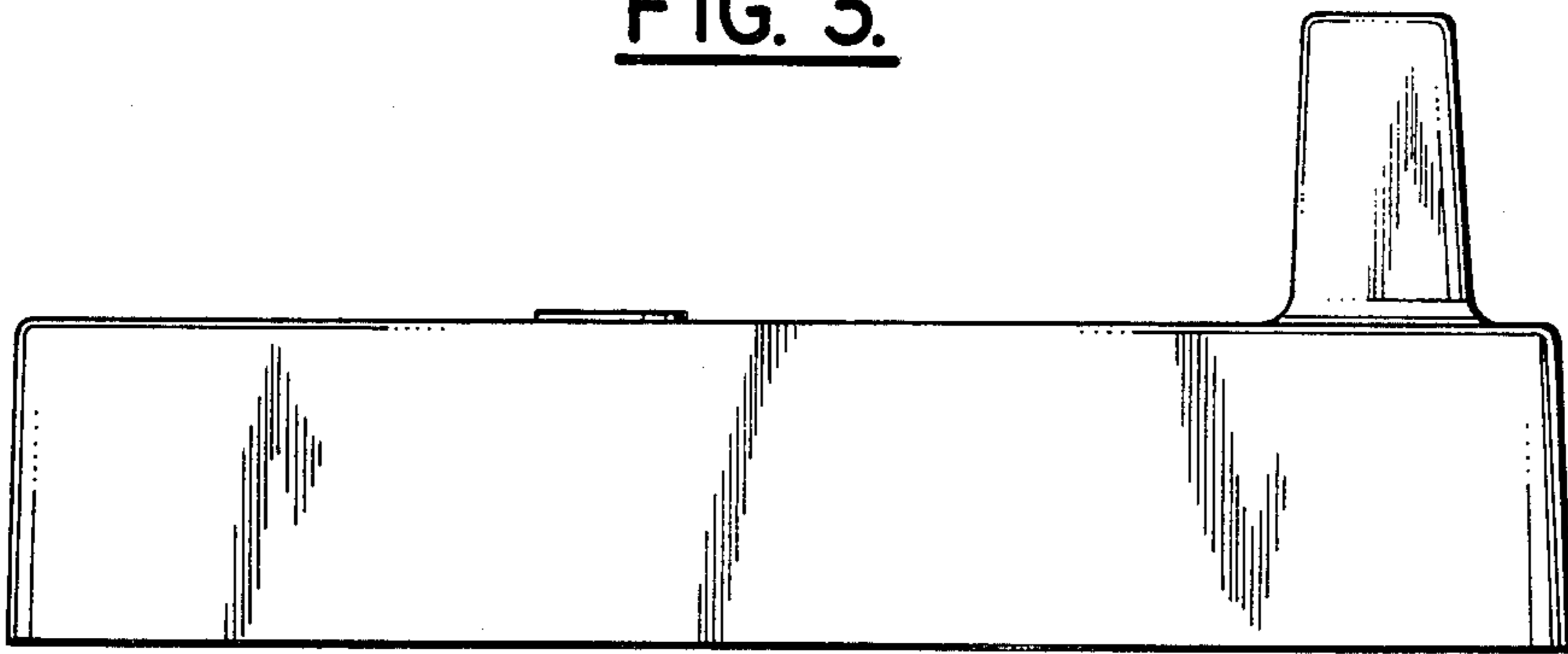

FIG. 4.

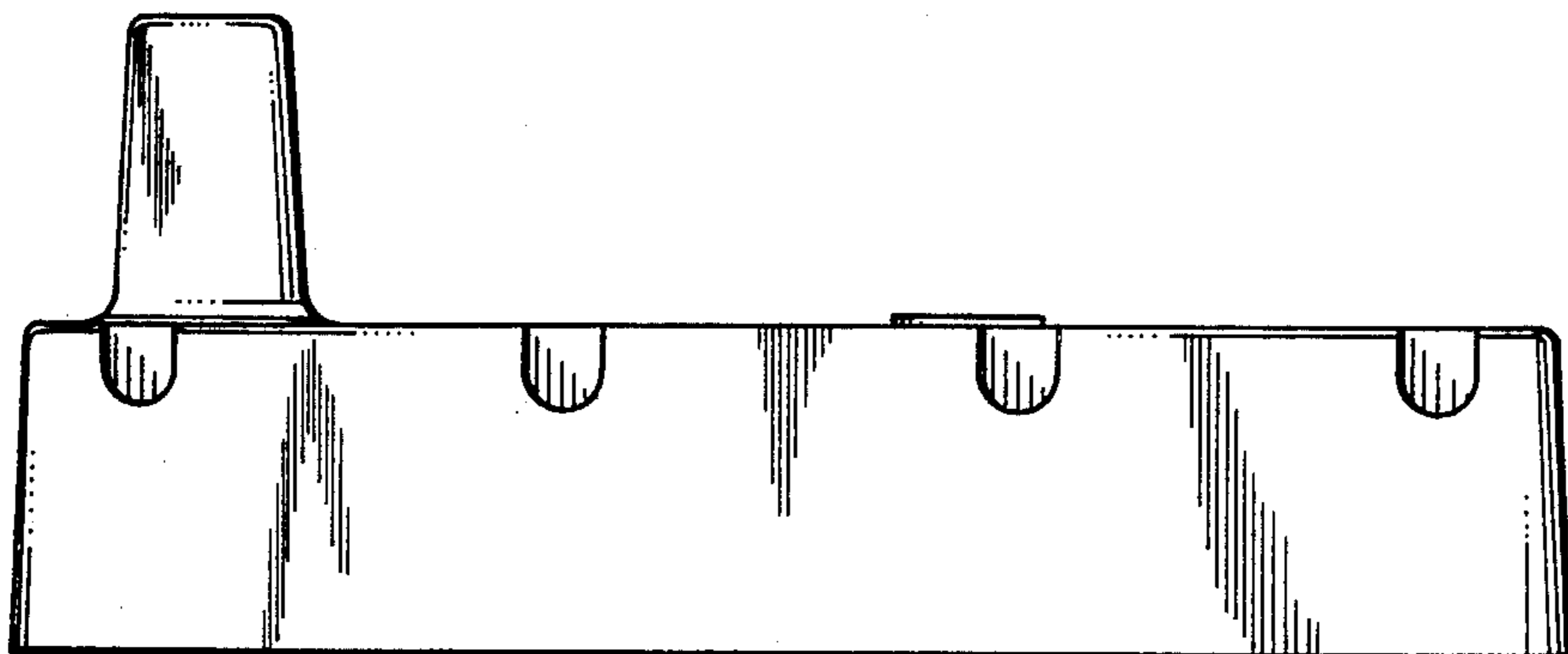

FIG. 5.

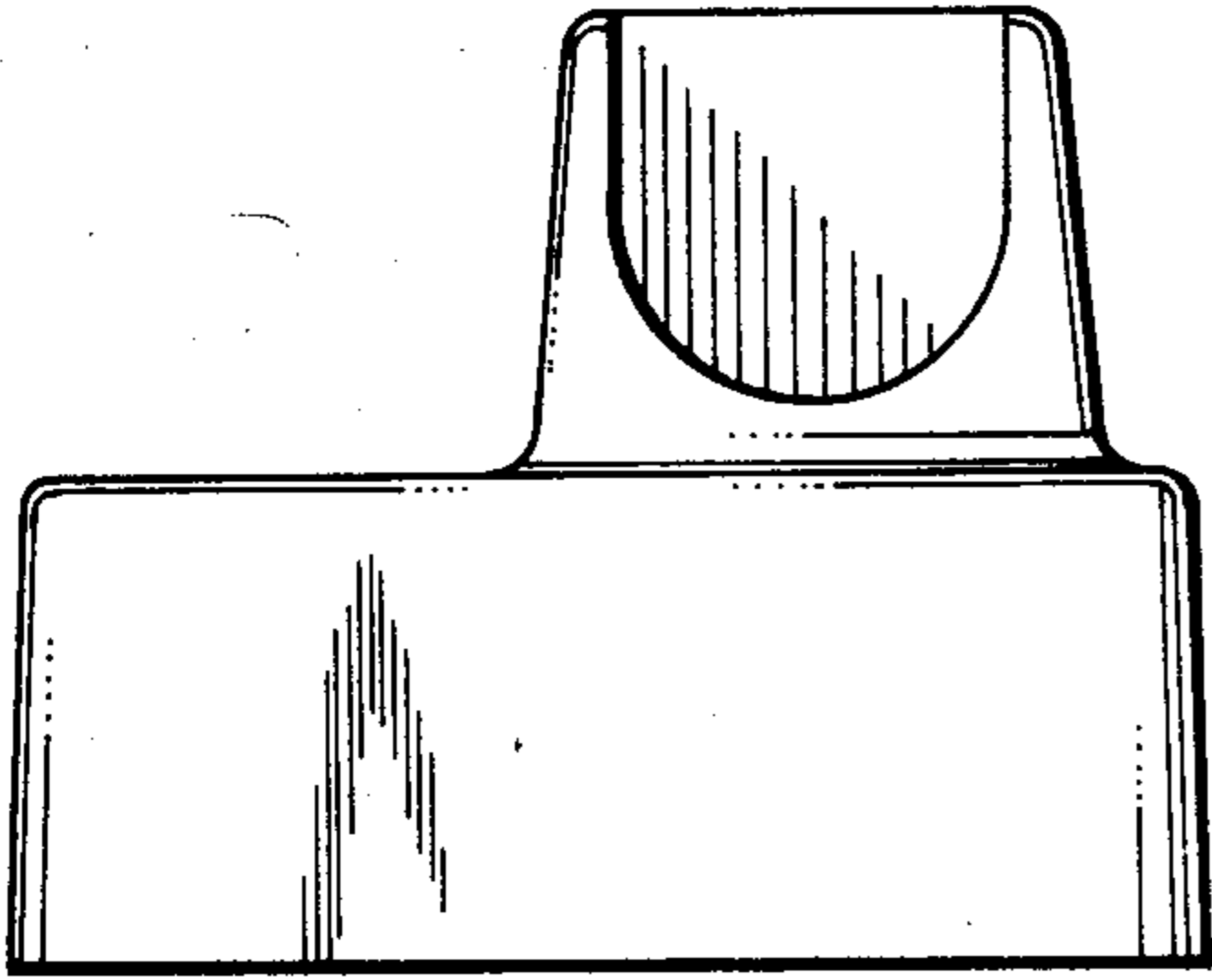

FIG. 6.

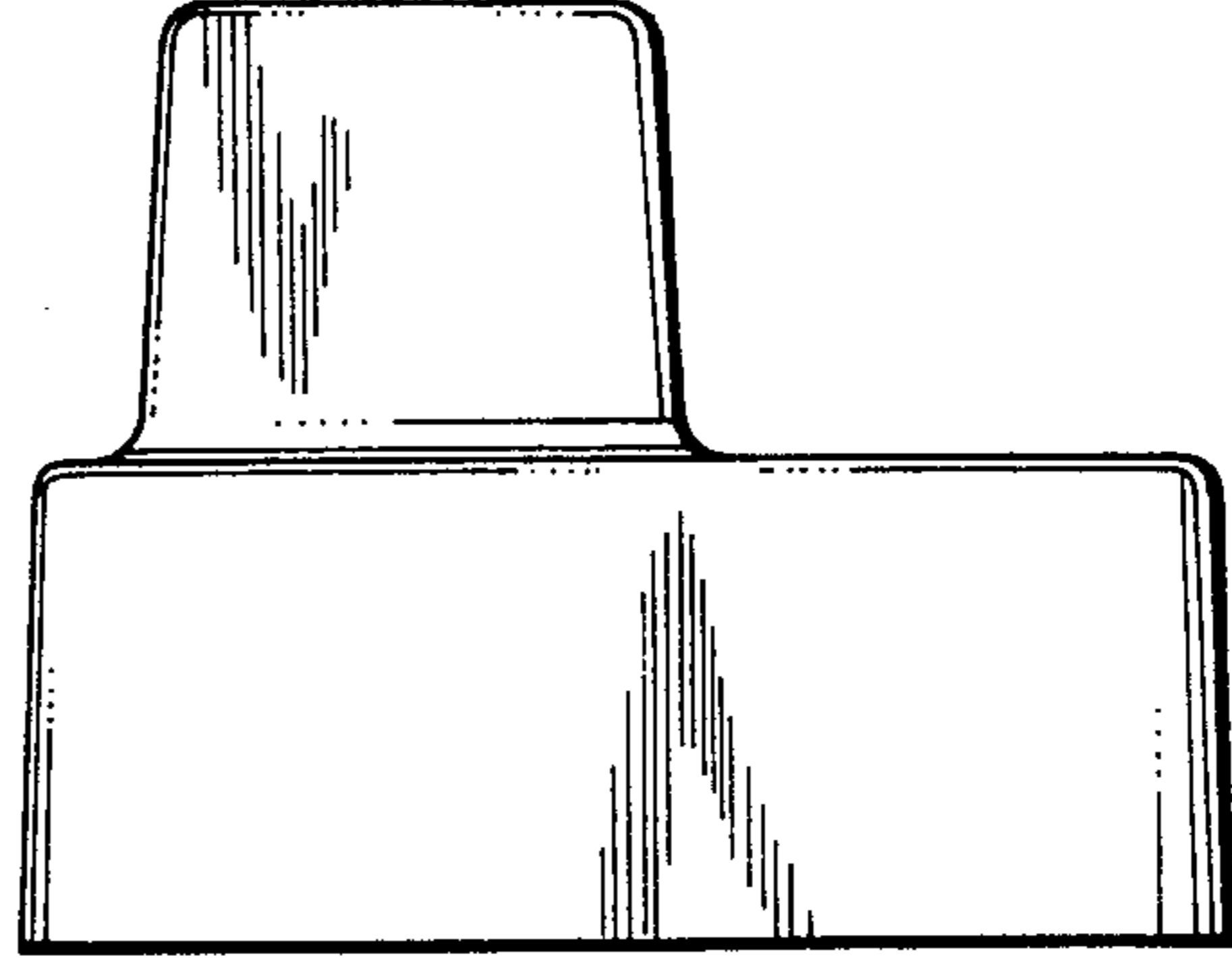

FIG. 7.

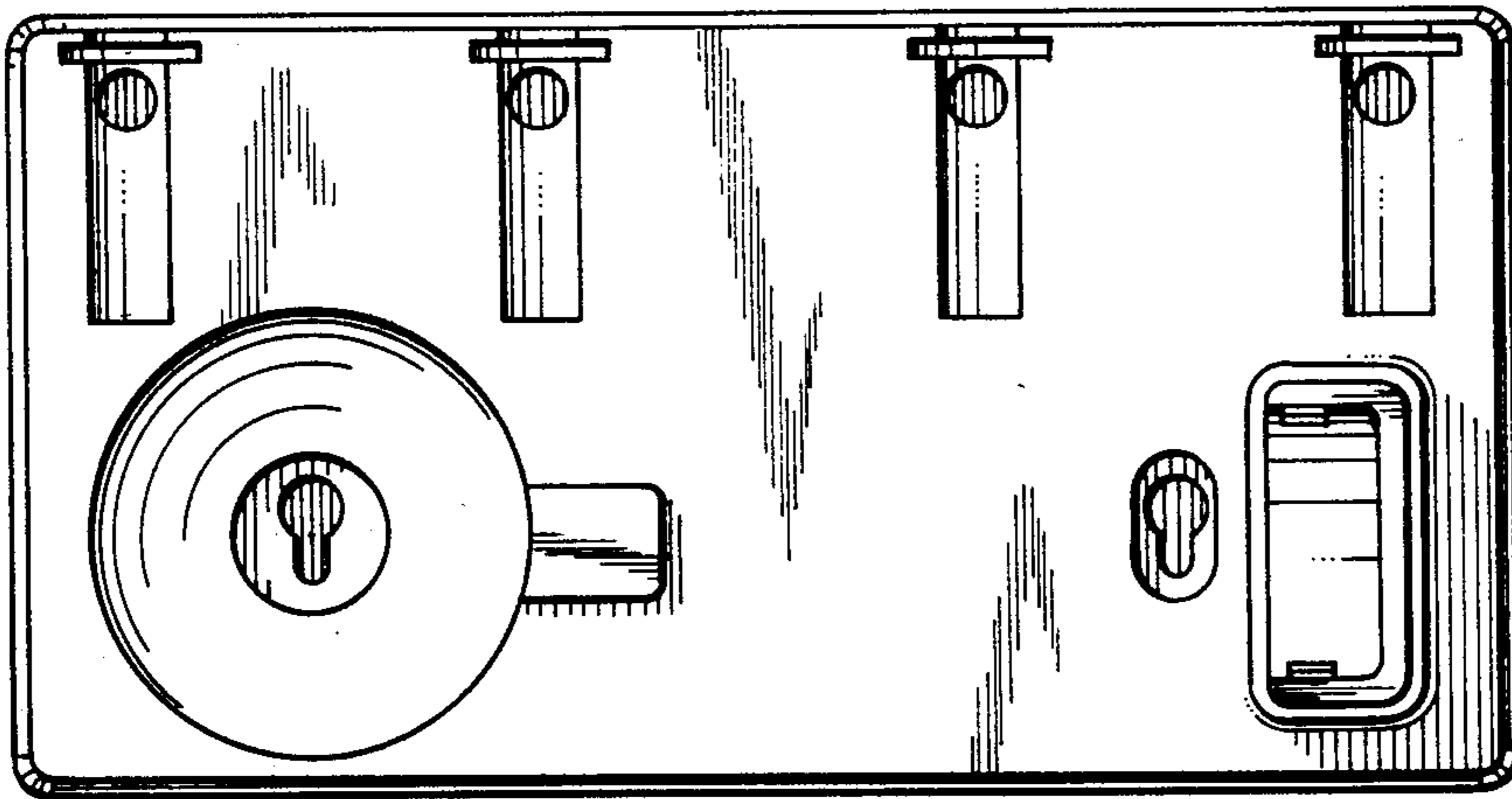

FIG. 8.

