

[54] **LASER BEAM PRINTER**

[56] **References Cited**

[75] **Inventors: Tatsuo Kojima, Asaka; Takashi Yomo, Yokohama, both of Japan**

U.S. PATENT DOCUMENTS

D. 208,279 8/1967 Brosseau, Jr. et al. D18/13
D. 258,060 1/1981 Shea D14/111

[73] **Assignee: Canon Kabushiki Kaisha, Tokyo, Japan**

Primary Examiner—Susan J. Lucas
Attorney, Agent, or Firm—Fitzpatrick, Cella, Harper & Scinto

[**] **Term: 14 Years**

[57] **CLAIM**

The ornamental design for a laser beam printer, as shown and described.

[21] **Appl. No.: 598,268**

DESCRIPTION

[22] **Filed: Apr. 9, 1984**

FIG. 1 is a front elevational view of the laser beam printer showing our new design;
FIG. 2 is a rear elevational view thereof;
FIG. 3 is a top plan view thereof;
FIG. 4 is a bottom plan view thereof;
FIG. 5 is a left side elevation view thereof;
FIG. 6 is a right side elevational view thereof;
FIG. 7 is a rear perspective view thereof; and
FIG. 8 is a front perspective view thereof.

[30] **Foreign Application Priority Data**

Oct. 12, 1983 [JP] Japan 58-44423
[52] **U.S. Cl. D14/111**
[58] **Field of Search D14/100, 107, 111; D18/13, 22; 400/693**

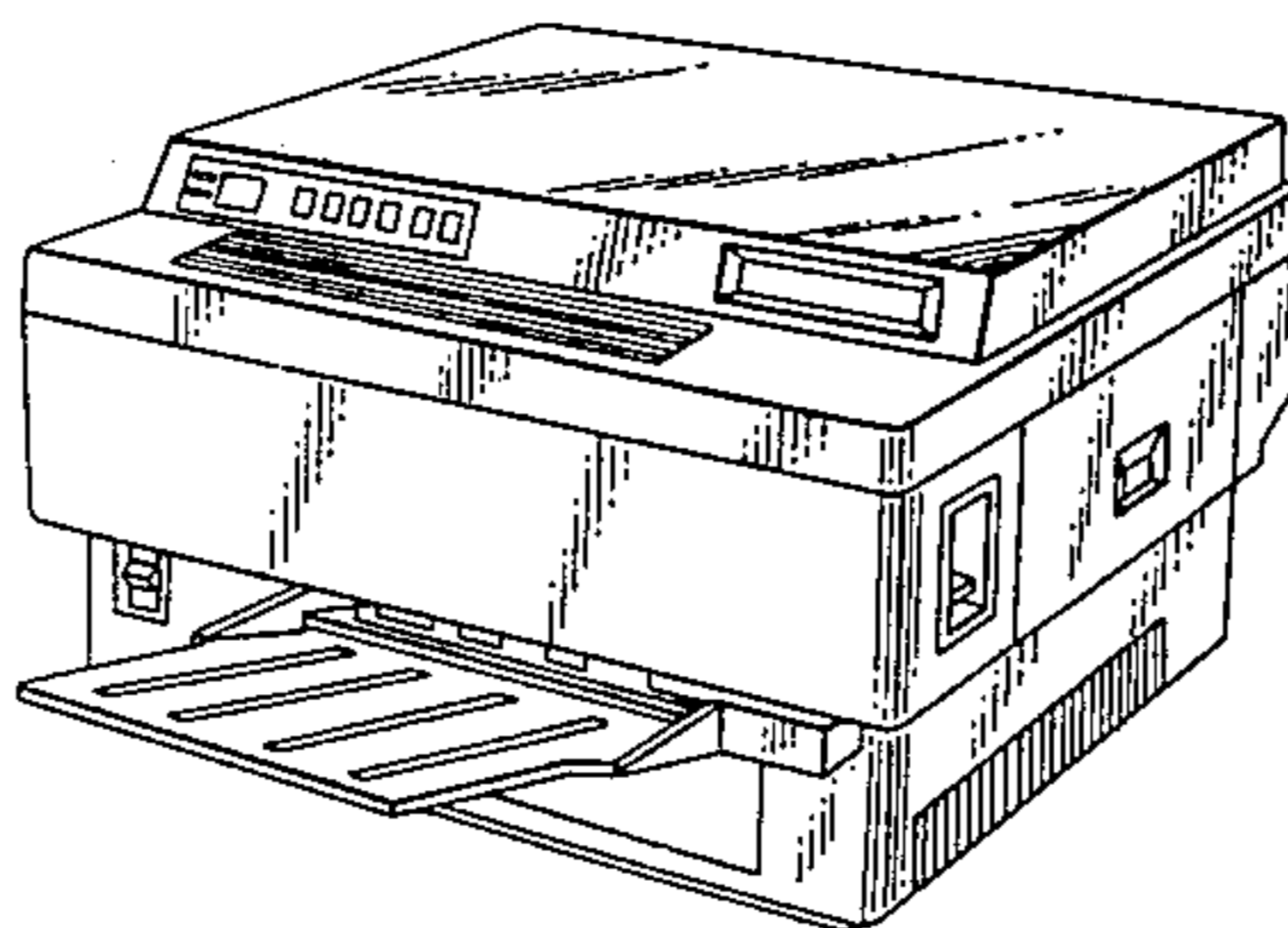

FIG. 1

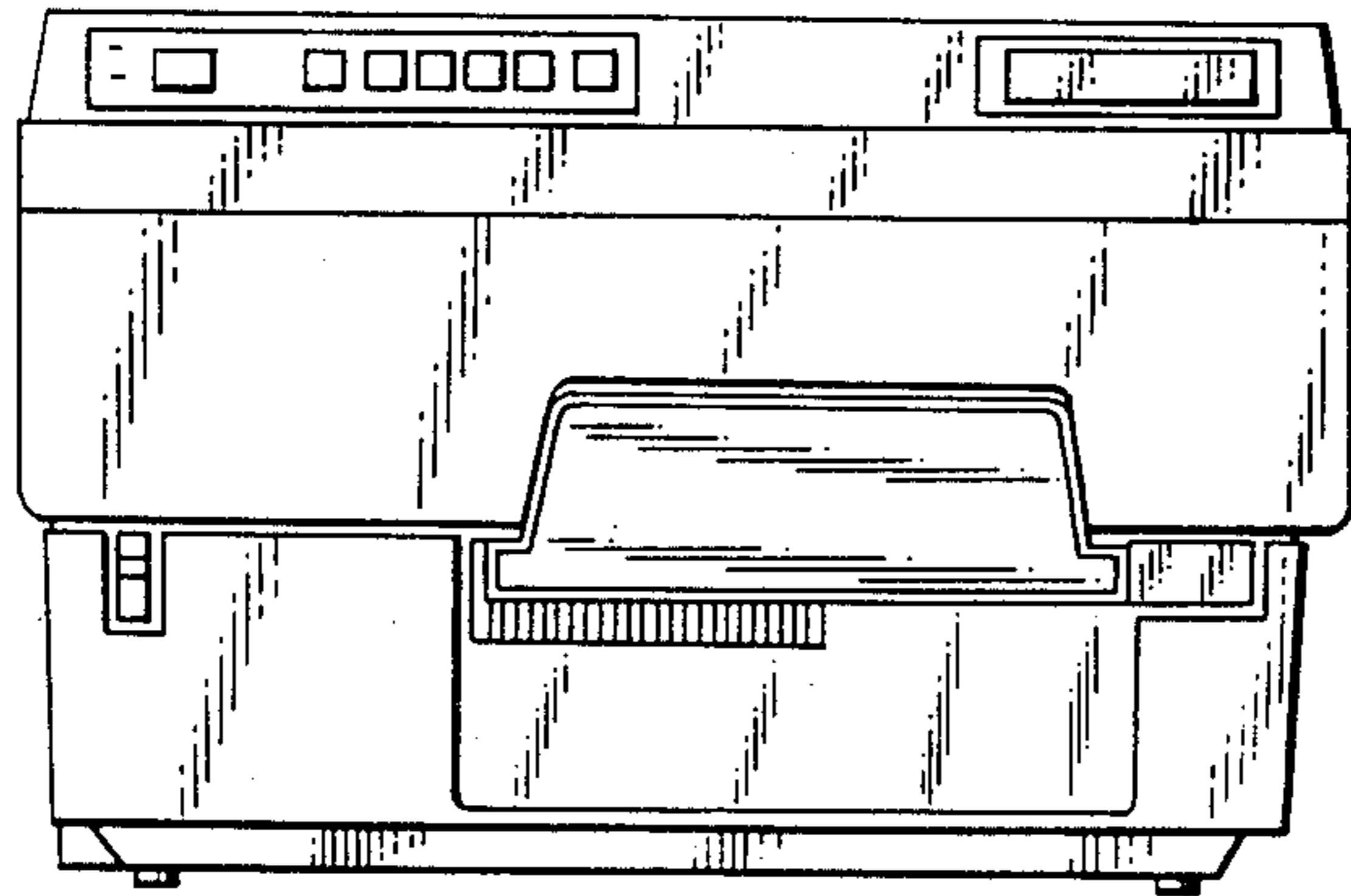

FIG. 2

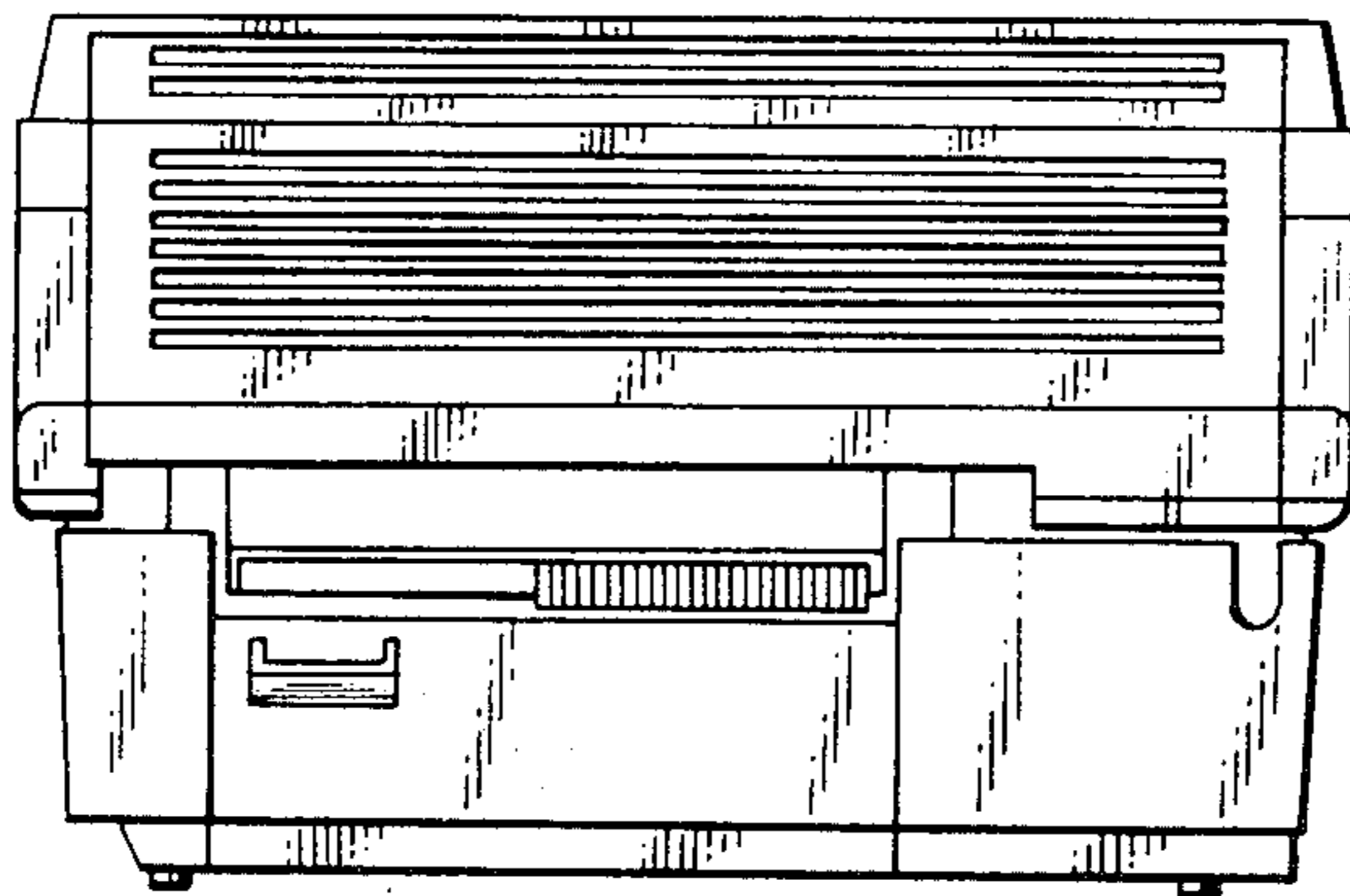

FIG. 4

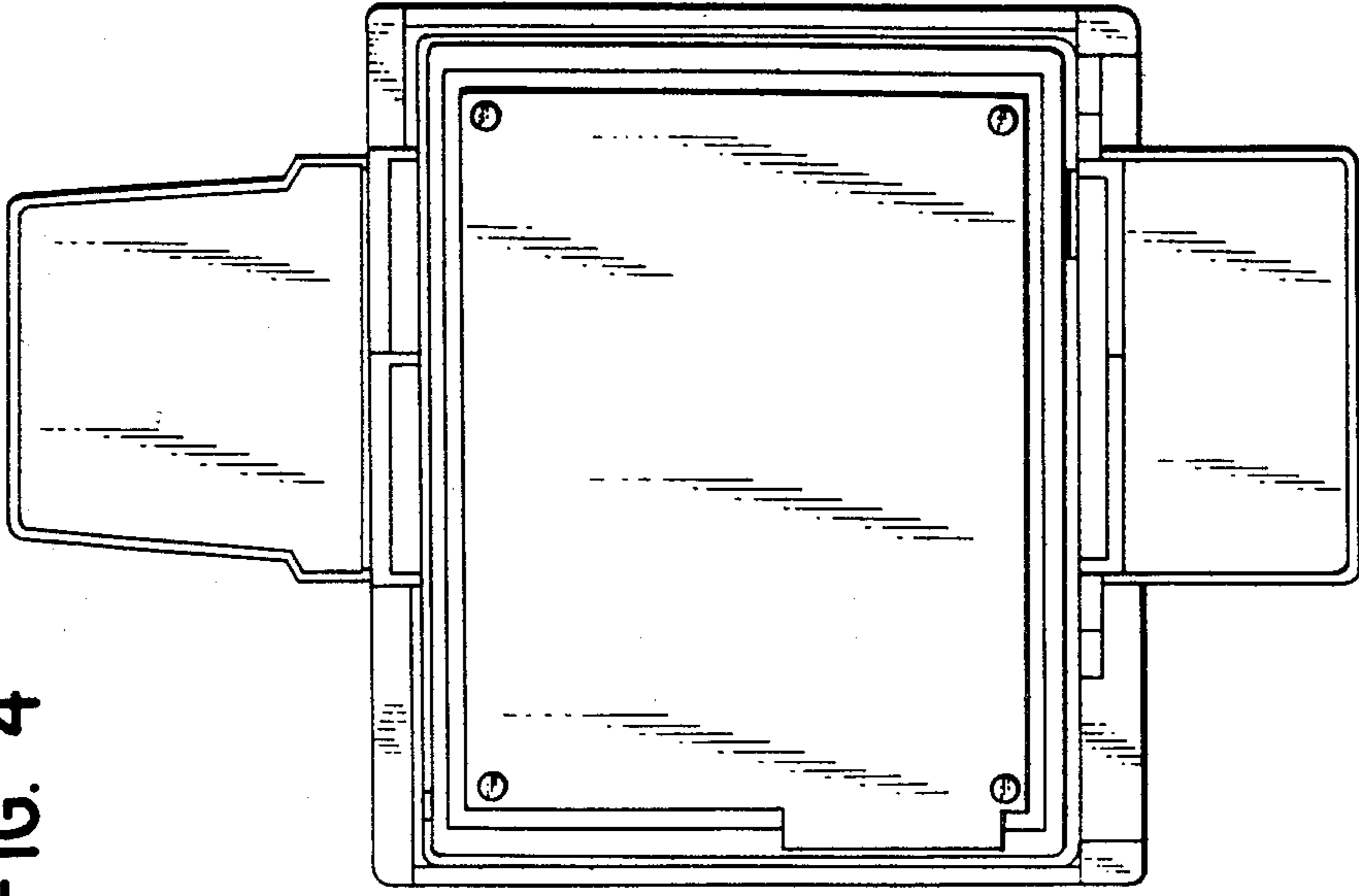

FIG. 3

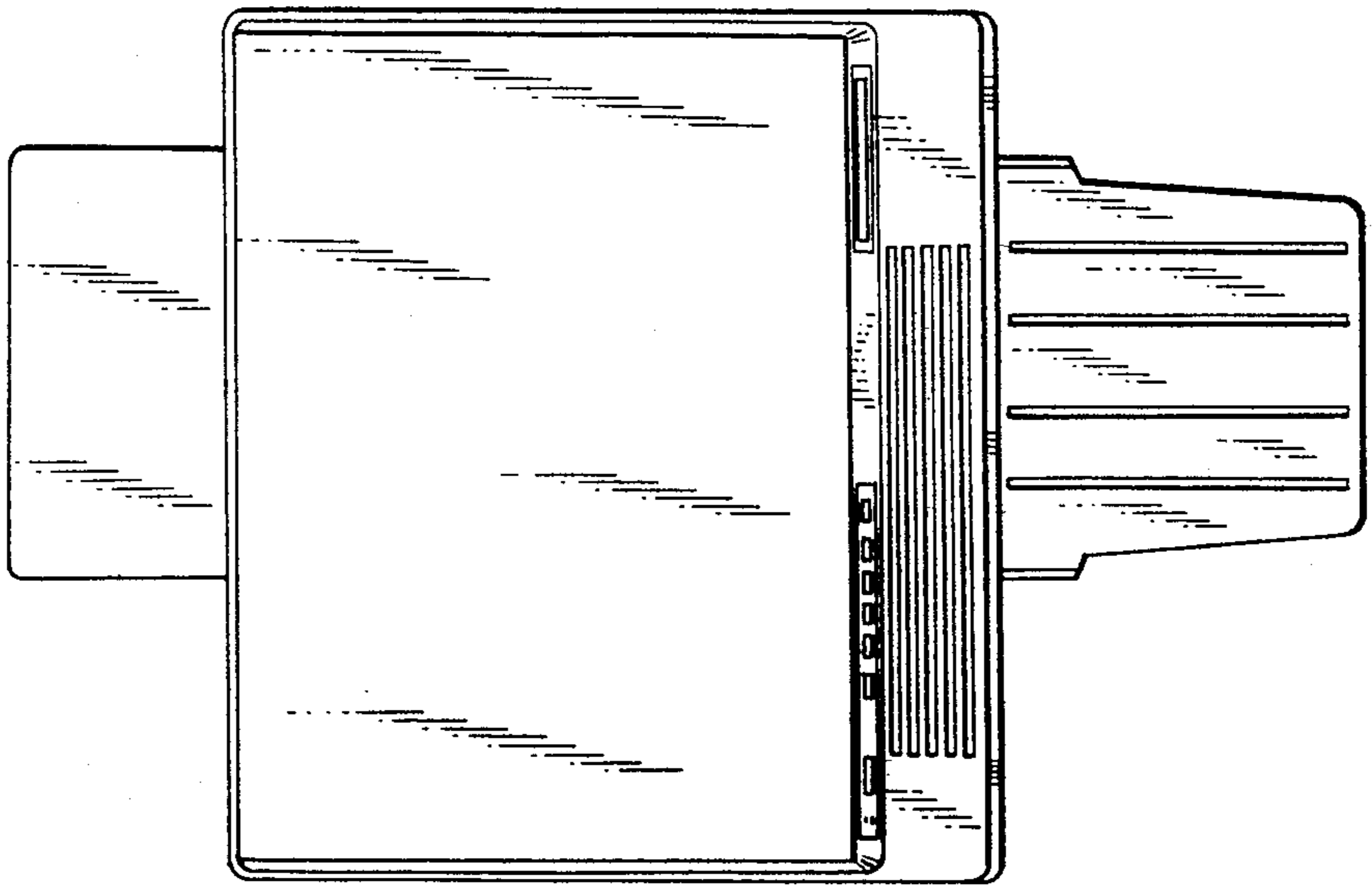

FIG. 5

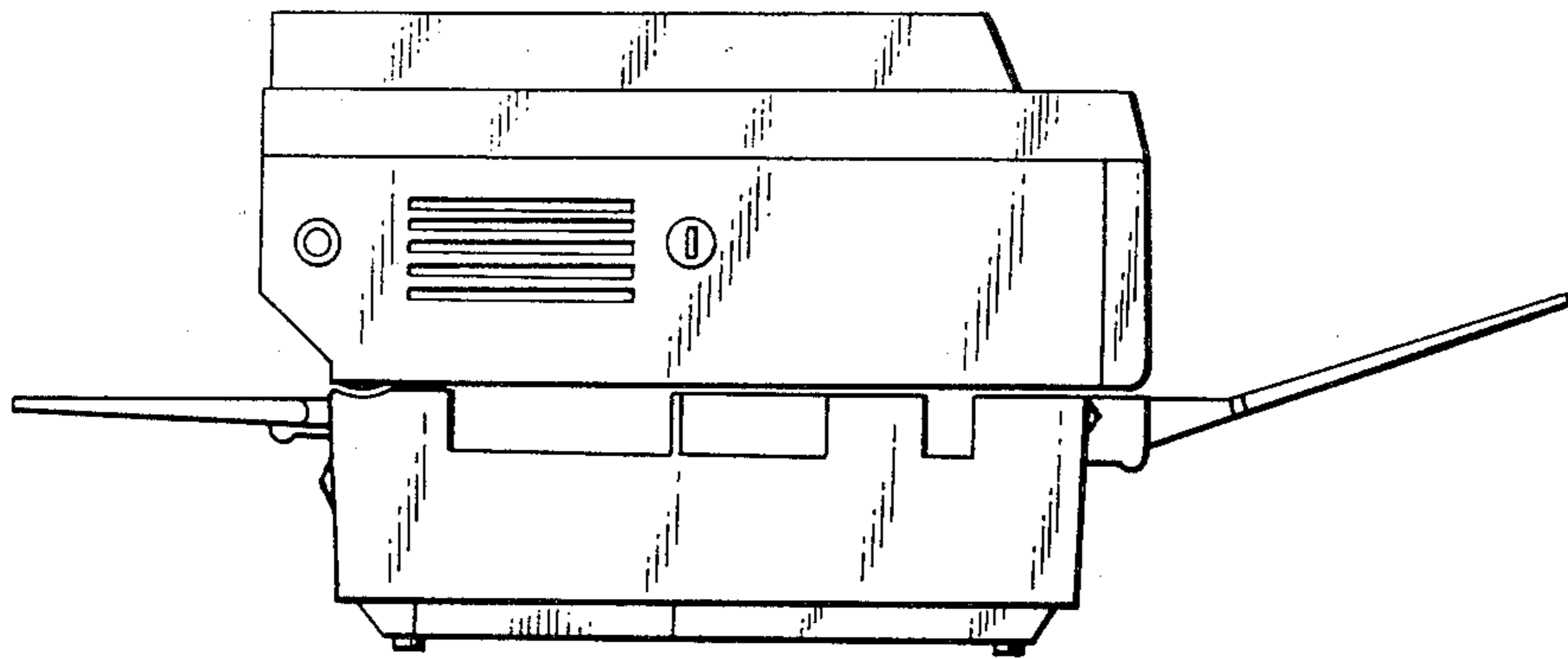

FIG. 6

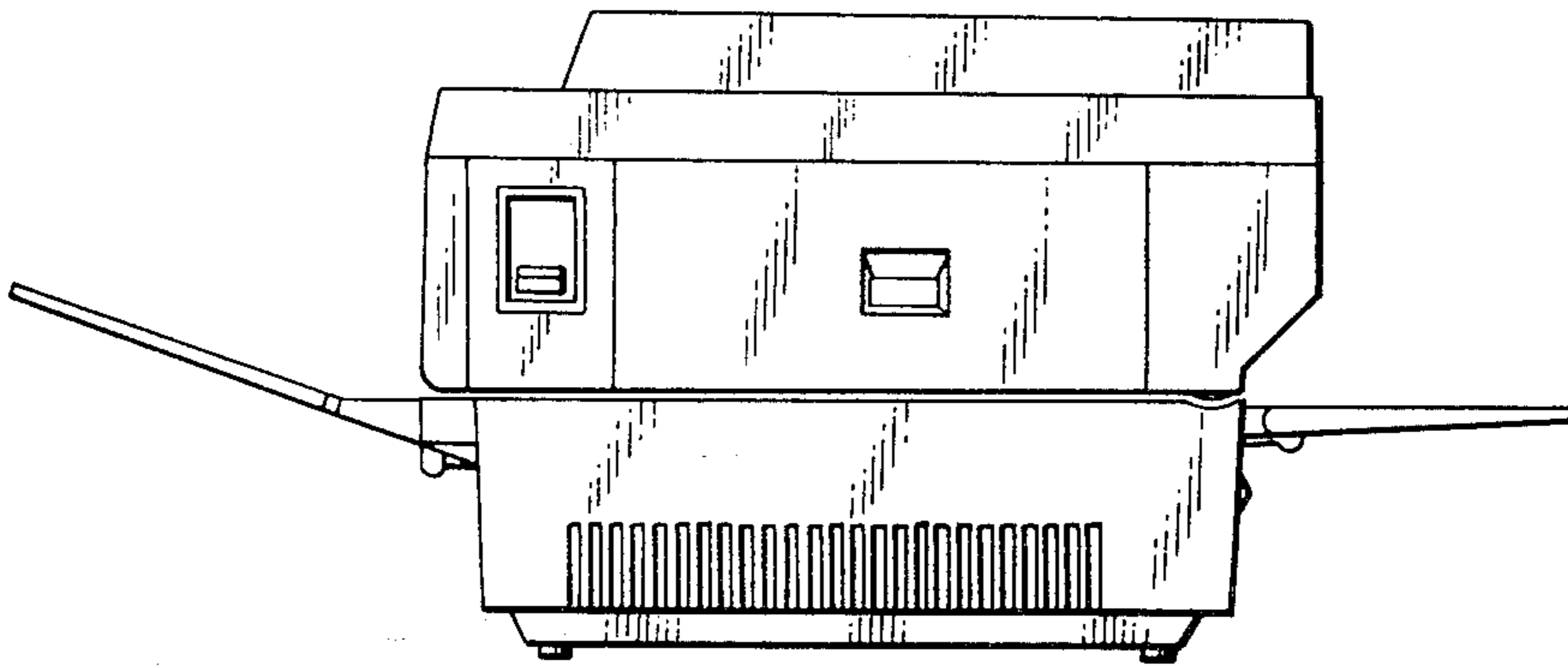

FIG. 7

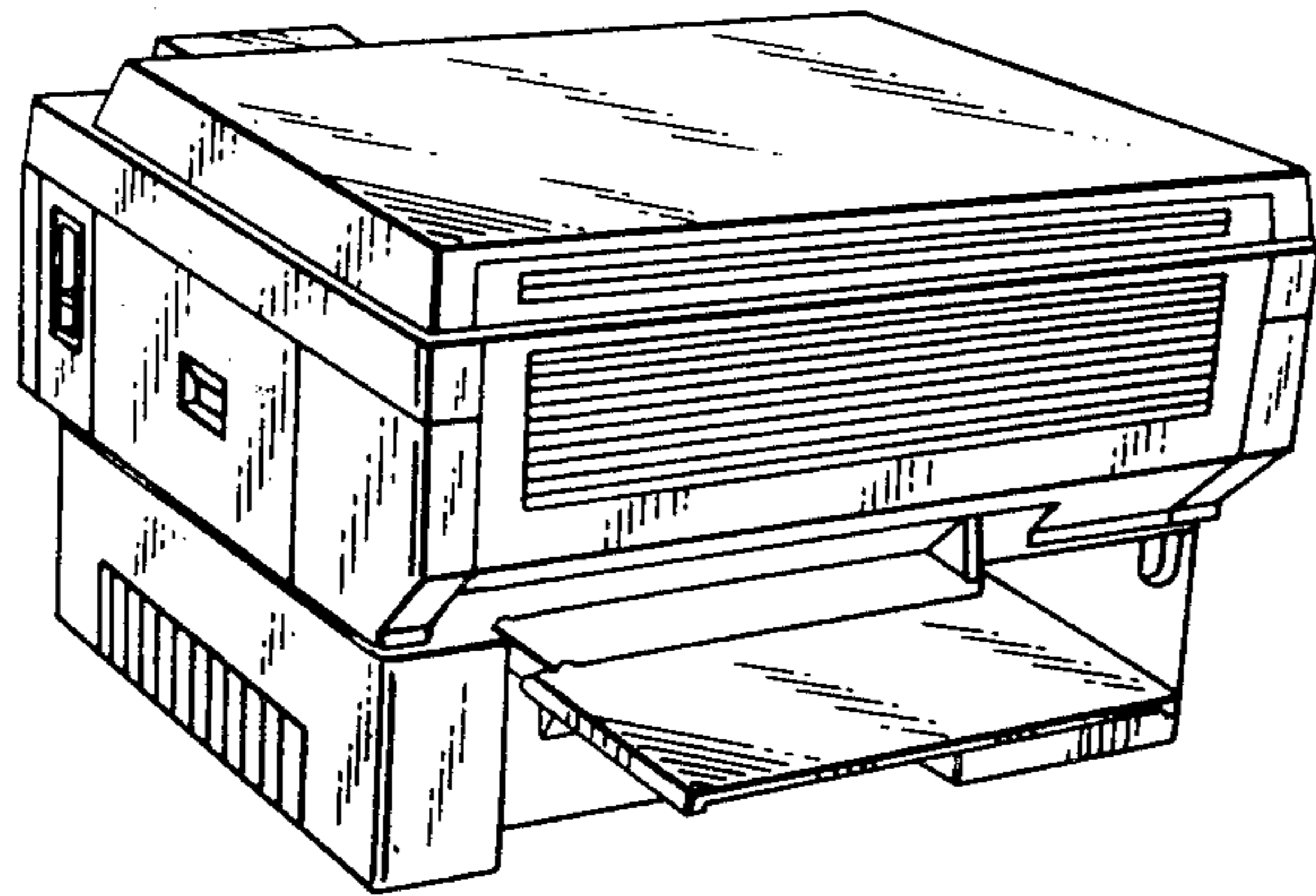

FIG. 8

