

[54] TELEPHONE STAND

[75] Inventor: Shigeaki Kido, Tokyo, Japan

[73] Assignee: Meisei Electric Co., Ltd., Tokyo, Japan

[**] Term: 14 Years

[21] Appl. No.: 689,177

[22] Filed: Jan. 7, 1985

[30] Foreign Application Priority Data

Jul. 28, 1984 [JP] Japan 59-31976
Nov. 21, 1984 [JP] Japan 59-47925

[52] U.S. Cl. D14/62; D14/58; D14/53

[58] Field of Search D14/52, 53, 58, 60, D14/62, 66

[56] References Cited

U.S. PATENT DOCUMENTS

D. 265,087	6/1982	Gamaguchi	D14/53
D. 267,873	2/1983	Brown et al.	D14/60
D. 275,481	9/1984	Foggia et al.	D14/58
D. 277,663	2/1985	Sakamoto et al.	D14/53
D. 277,929	3/1985	Sakamoto	D14/58
D. 278,903	5/1985	Ando	D14/53
D. 280,405	9/1985	Mitchell	D14/62
D. 280,617	9/1985	Inaba	D14/63
D. 280,720	9/1985	Miura et al.	D14/63
D. 281,422	11/1985	Miura et al.	D14/63
D. 282,545	2/1986	Inagi et al.	D14/53
D. 282,841	3/1986	Inaba	D14/53

OTHER PUBLICATIONS

"The Sharper Image Phone Book"; at p. 29, Pushbutton Keys on right side of right hand picture.

Primary Examiner—Wallace R. Burke
Assistant Examiner—Horace B. Fay

Attorney, Agent, or Firm—Toren, McGeady, Stanger, Goldberg & Kiel

[57] CLAIM

The ornamental design for a telephone stand, as shown and described.

DESCRIPTION

FIG. 1 is a front, top and right side perspective view of a telephone stand showing my new design, with a handset and cord being represented in this and subsequent figures for illustrative, environmental association purposes only;

FIG. 2 is a top plan view thereof;

FIGS. 3 and 4 are respectively front and rear elevational views thereof;

FIGS. 5 and 6 are respectively right and left side elevational views thereof;

FIG. 7 is a bottom plan view thereof;

FIG. 8 is a front, top and right side perspective view of a second embodiment thereof;

FIG. 9 is a top plan view thereof;

FIG. 10 is a front, top and right side perspective view of a third embodiment thereof;

FIG. 11 is a top plan view thereof;

FIG. 12 is a front, top and right side perspective view of a fourth embodiment thereof;

FIG. 13 is a top plan view thereof;

FIG. 14 is a front, top and right side perspective view of a fifth embodiment thereof;

FIG. 15 is a top plan view thereof;

FIG. 16 is a front, top and right side perspective view of a sixth embodiment thereof;

FIG. 17 is a top plan view thereof.

It will be understood that the views in FIGS. 4 and 7 are common to all embodiments, and that the basic configuration of the views in FIGS. 3, 5, and 6 is representative of all embodiments except for obvious variation in surface ornamentation.

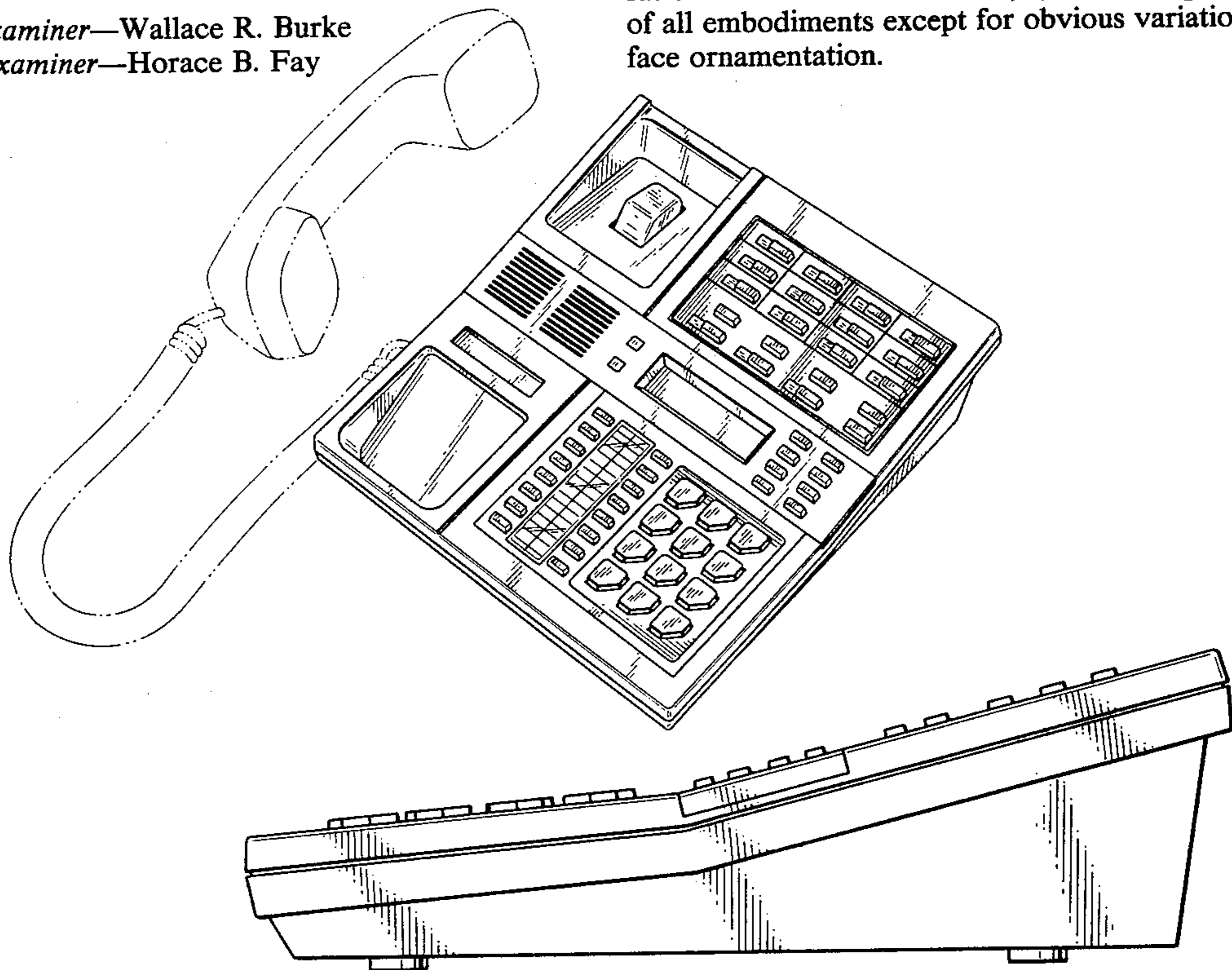

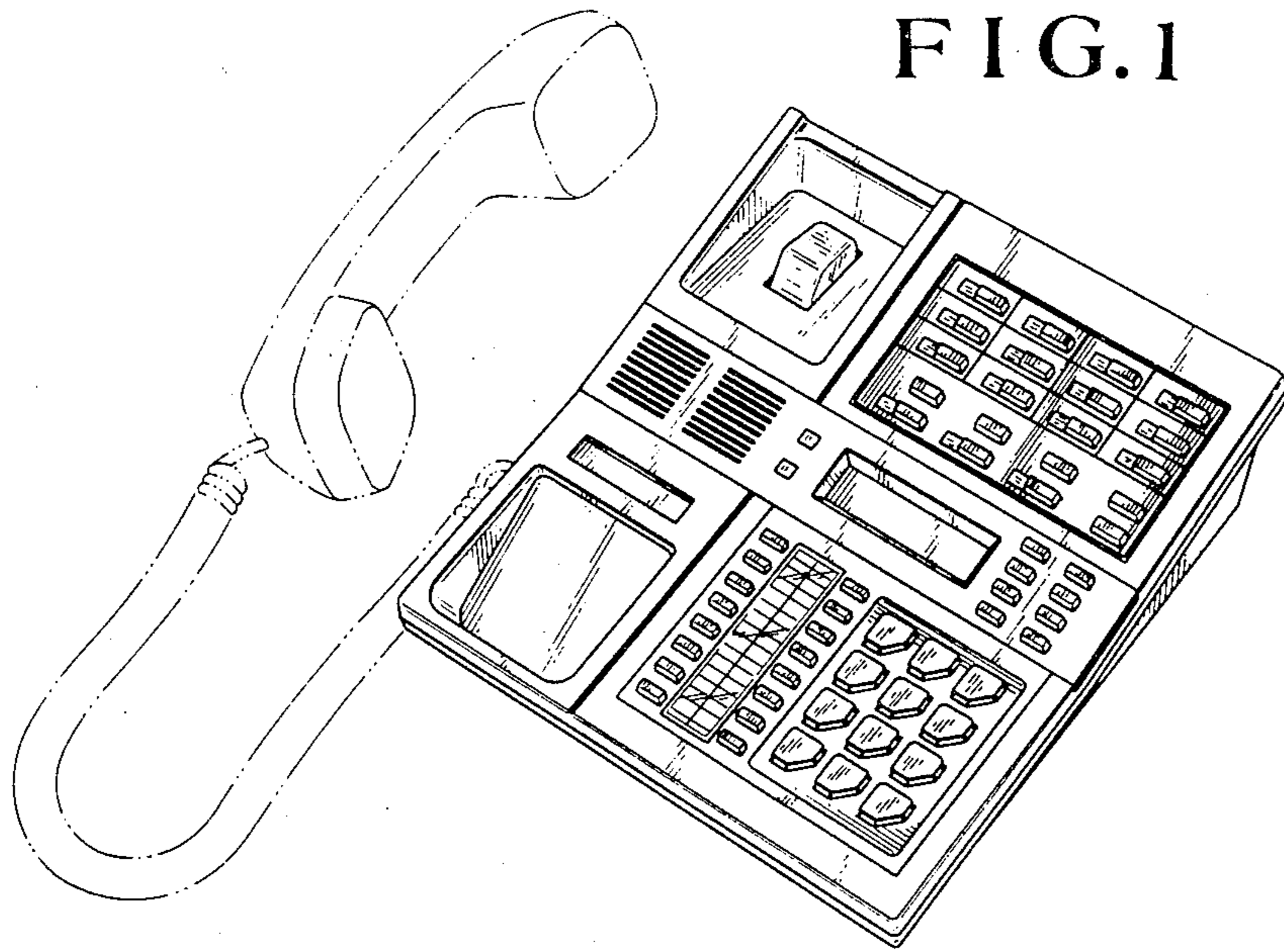

FIG. 2

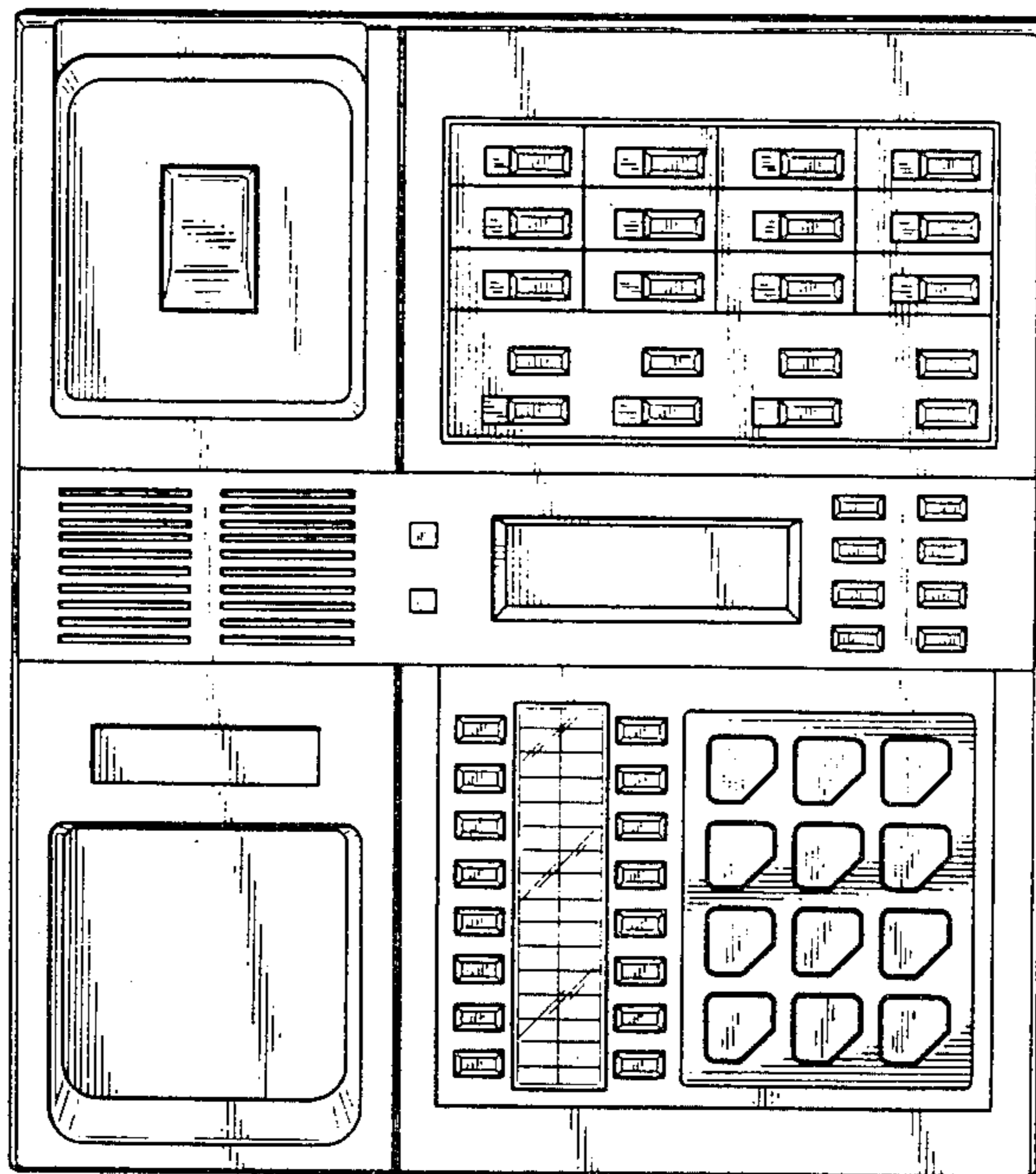

FIG.3

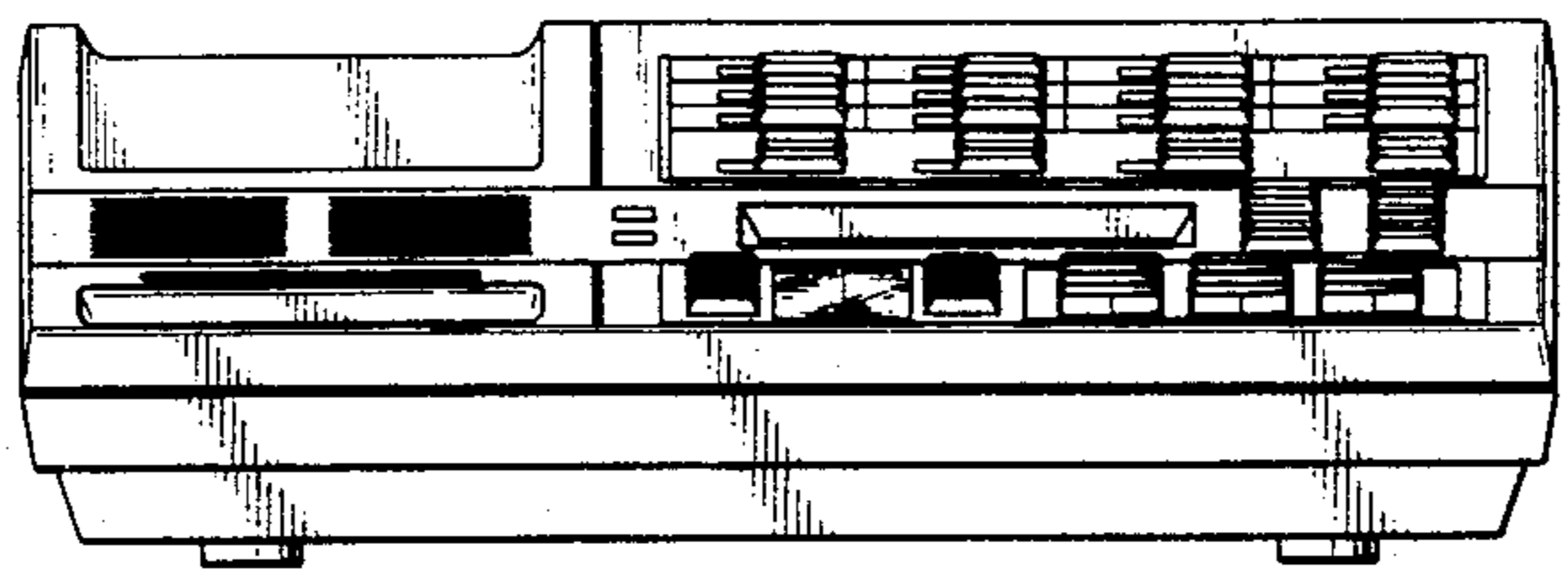

FIG.4

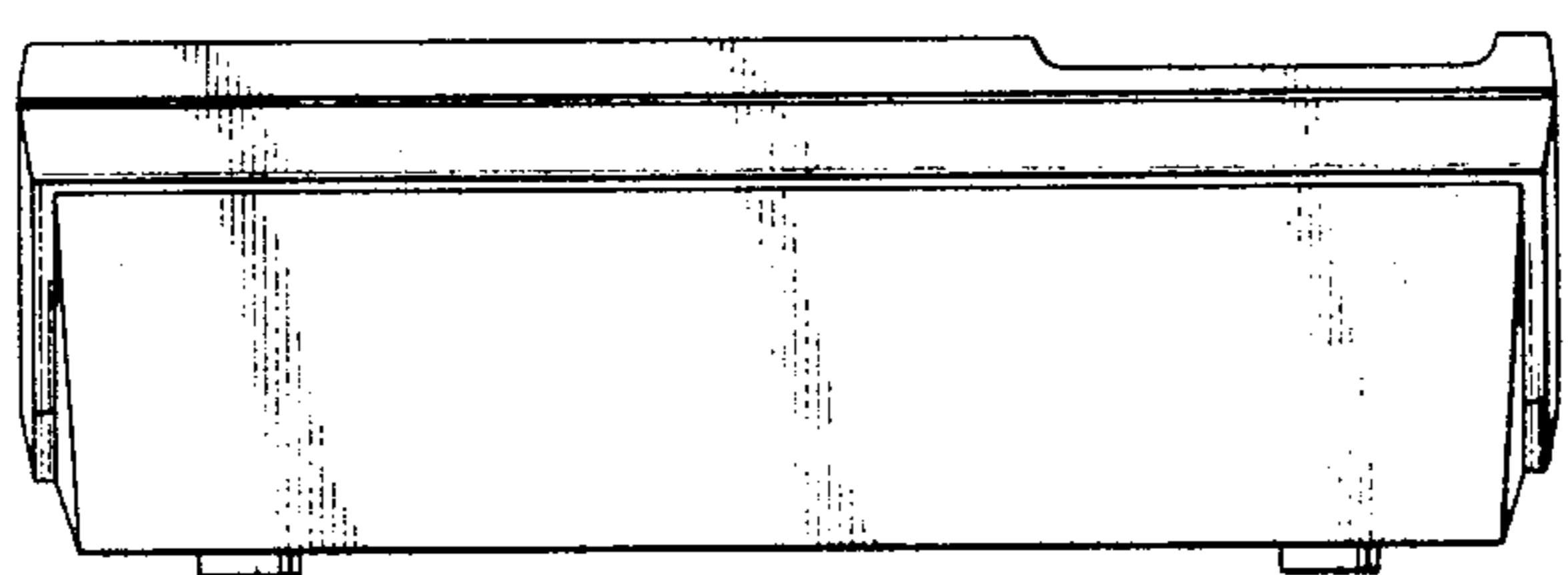

FIG.5

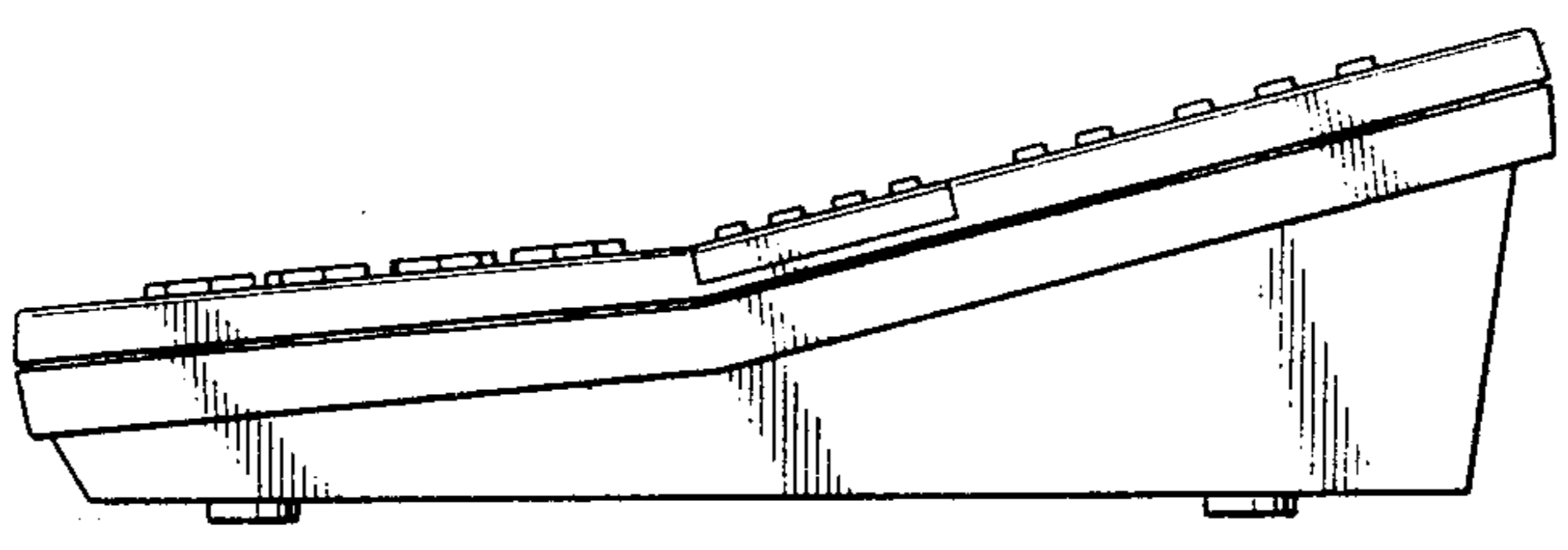

FIG.6

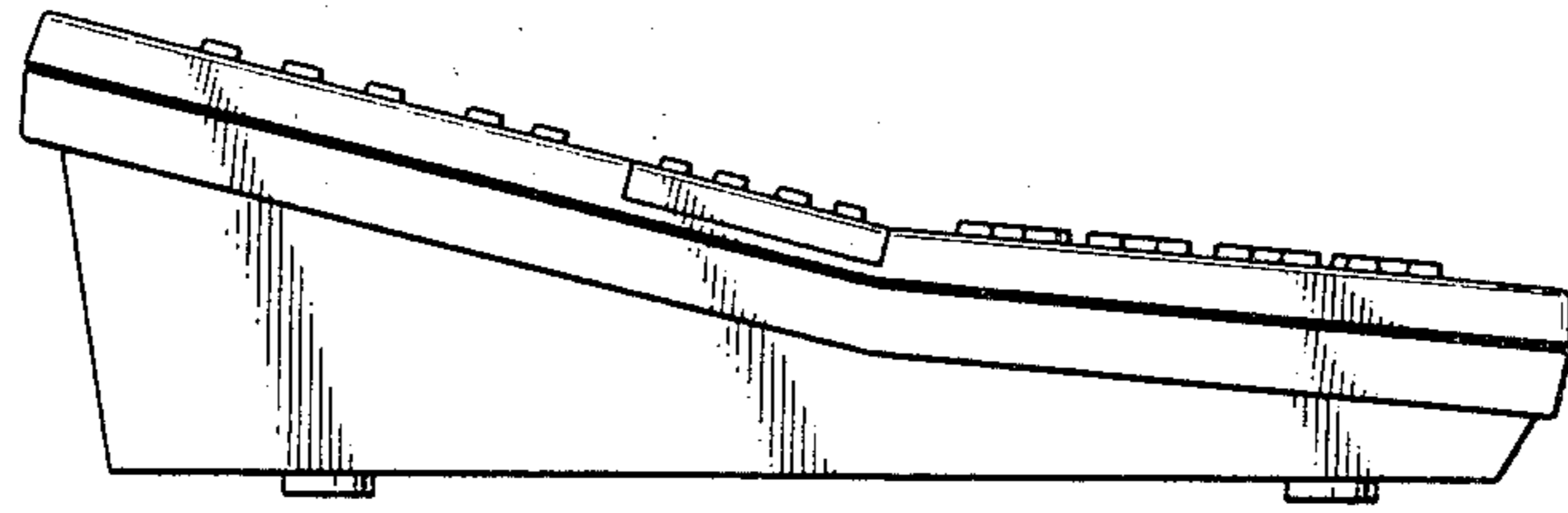

FIG.7

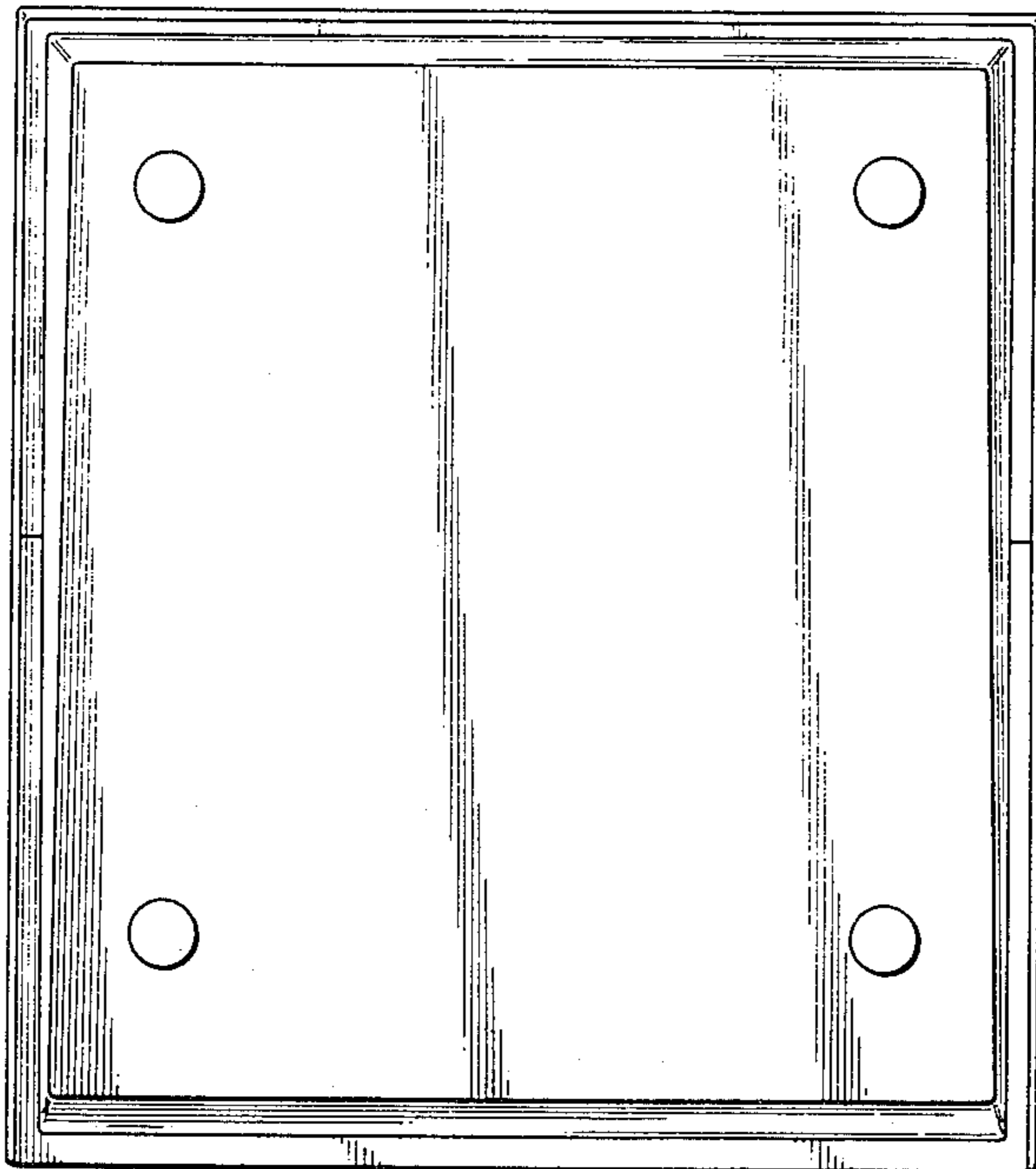

FIG. 8

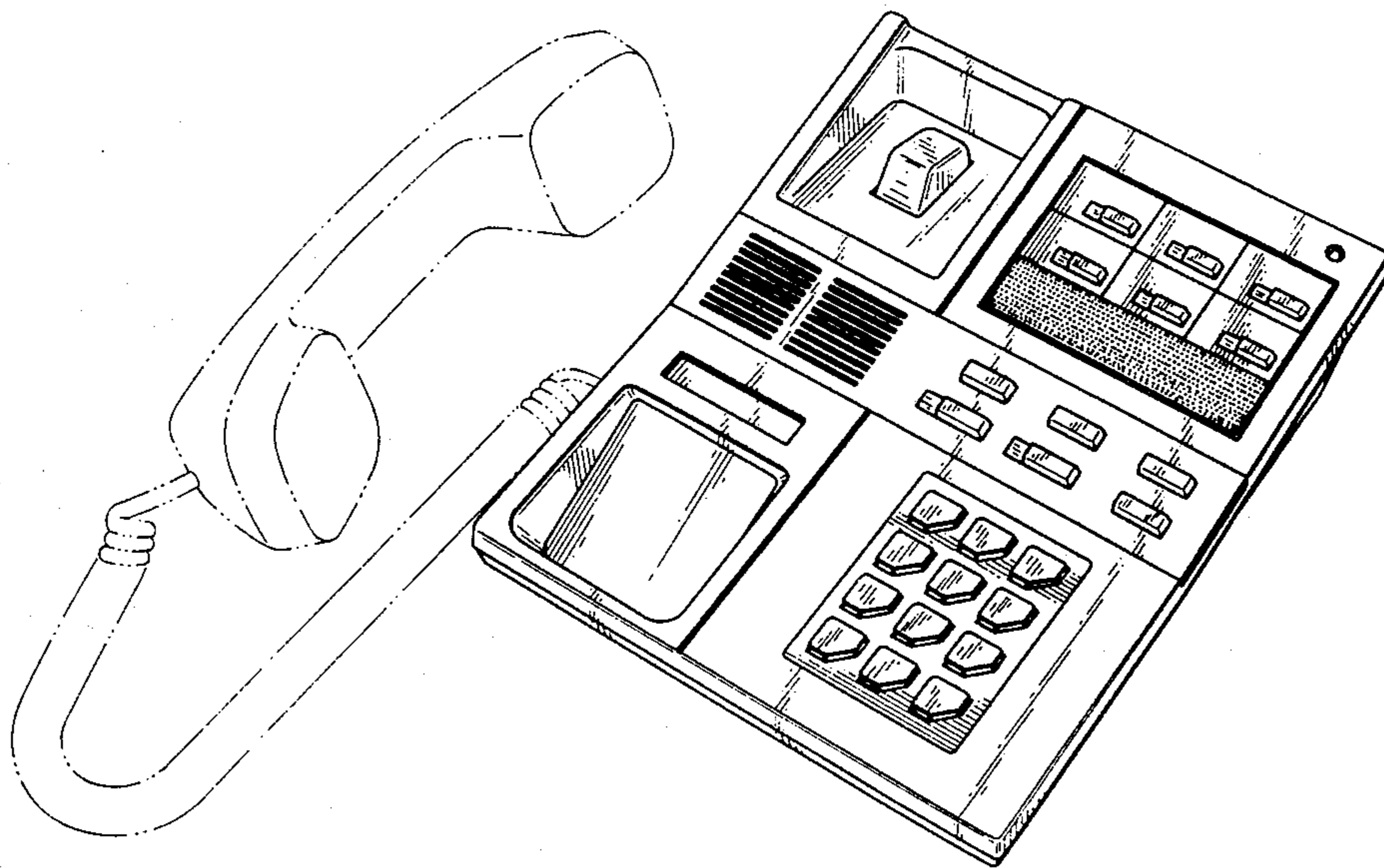

FIG. 9

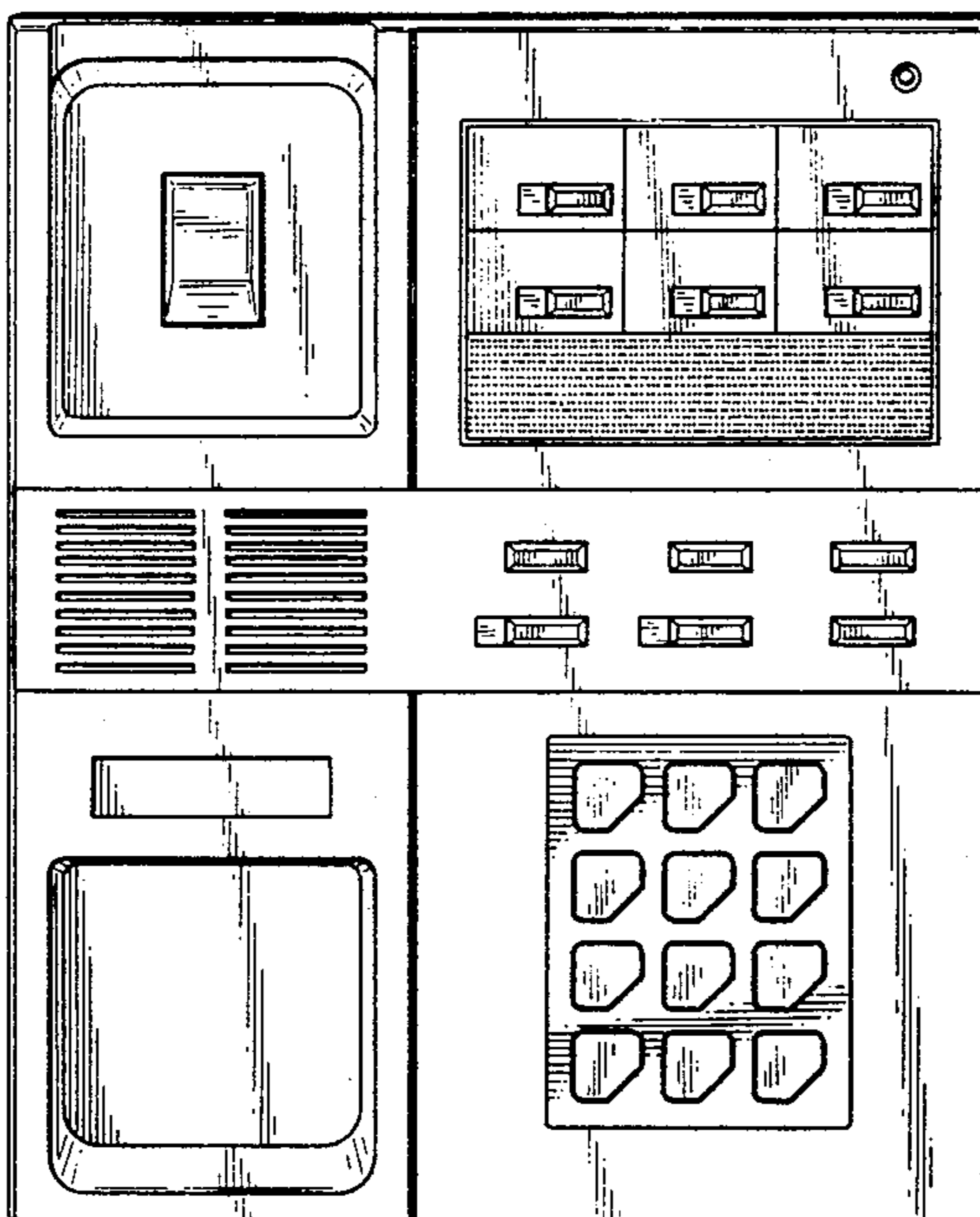

FIG. 10

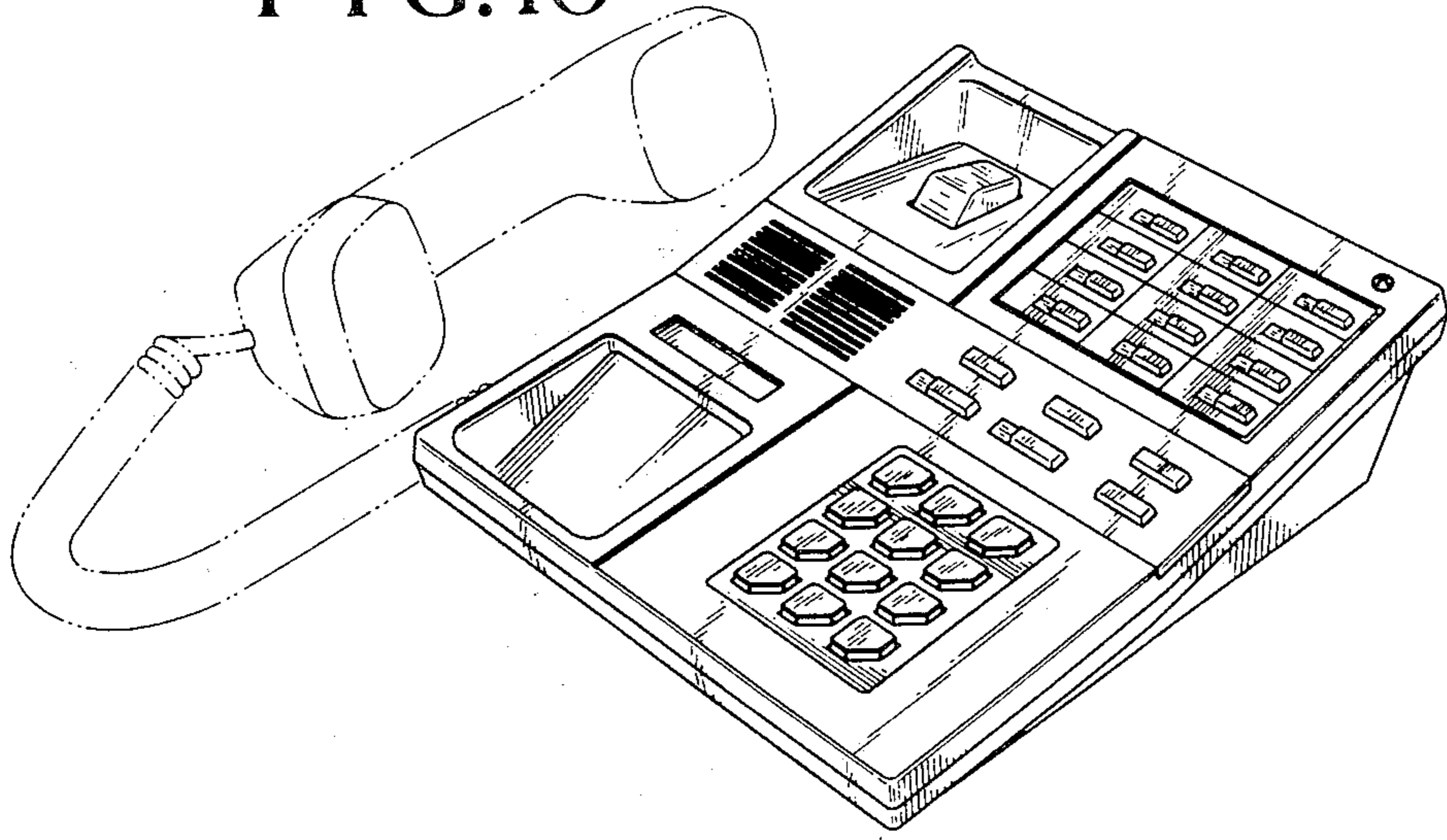

FIG. 11

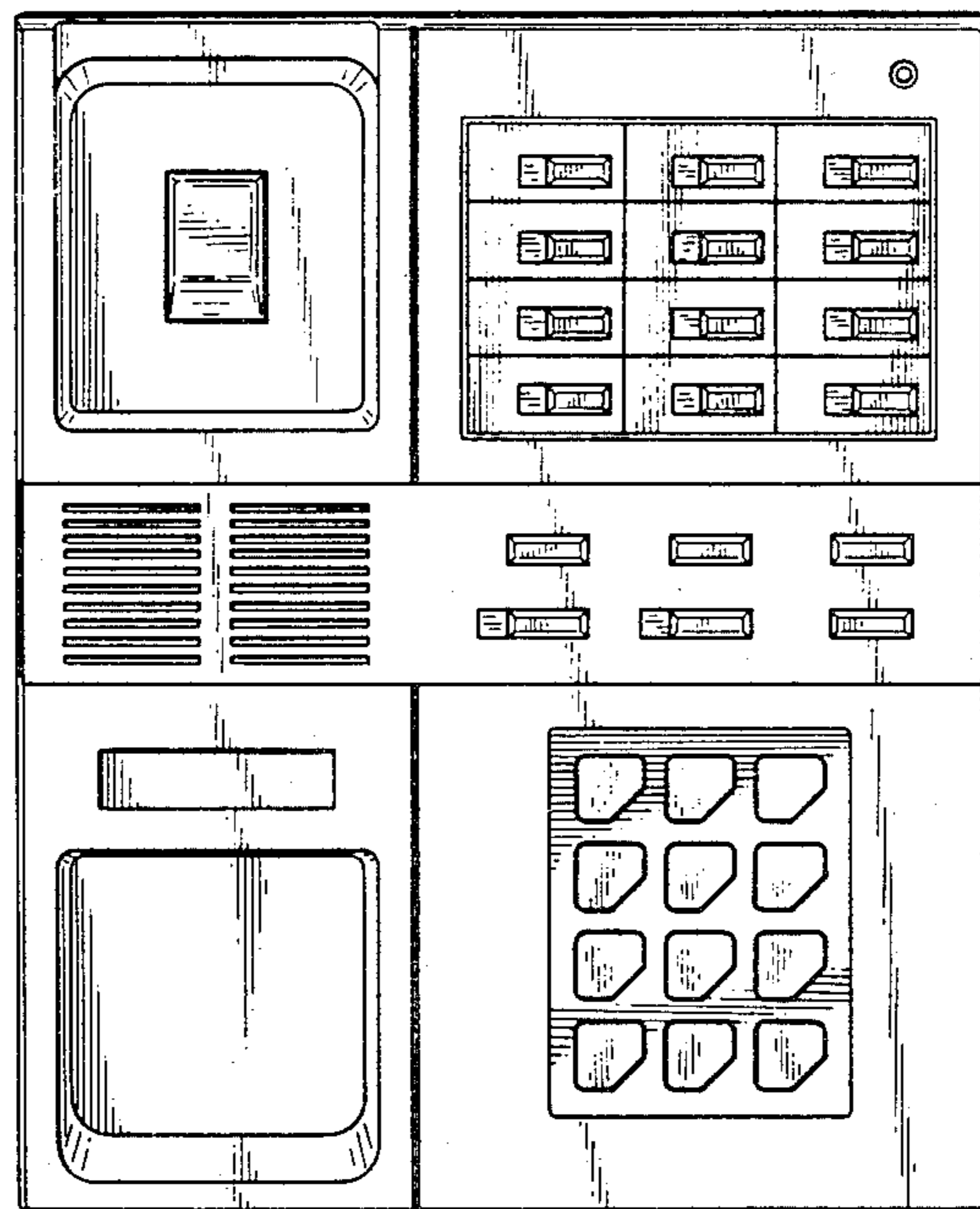

FIG. 12

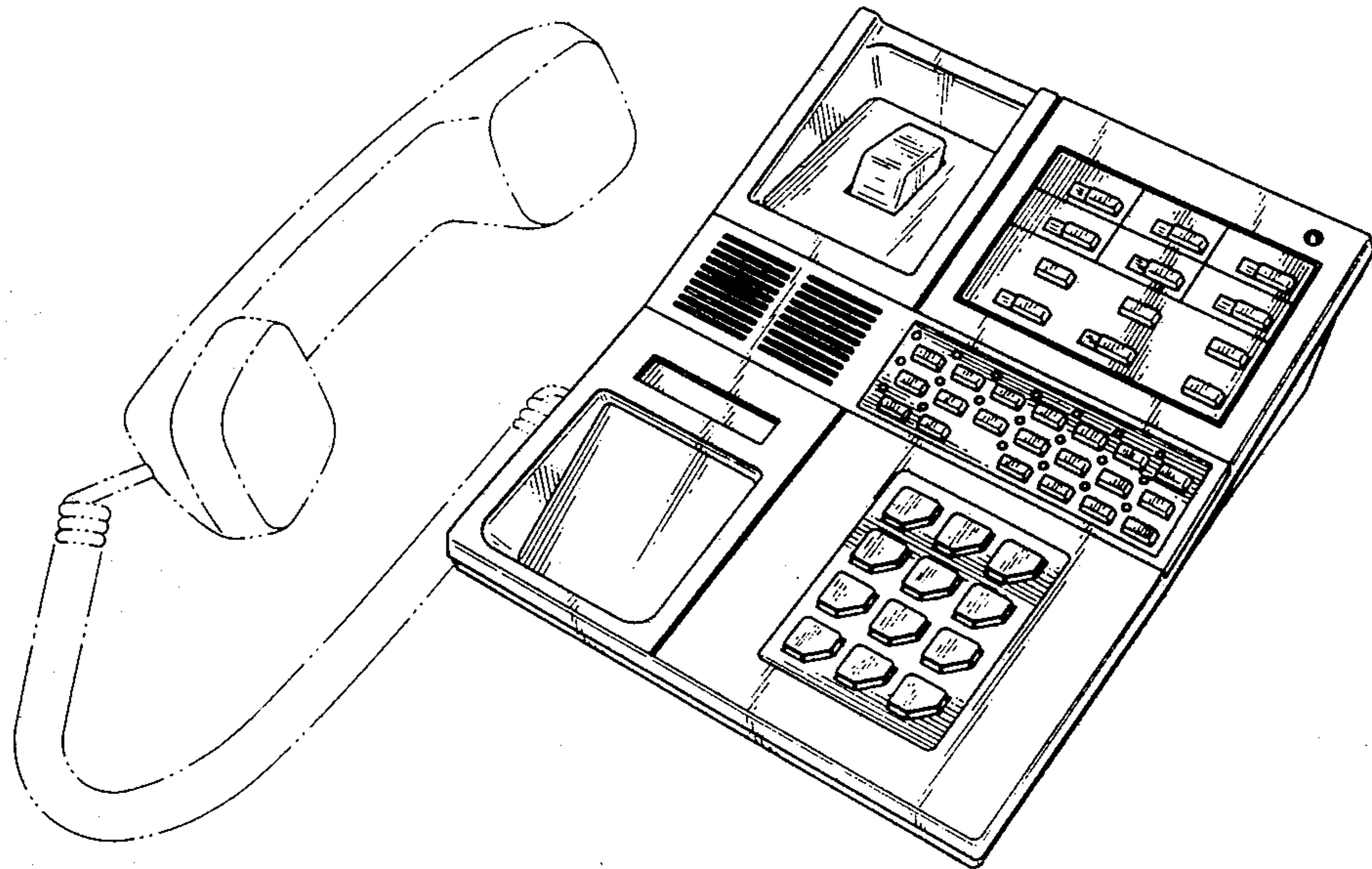

FIG. 13

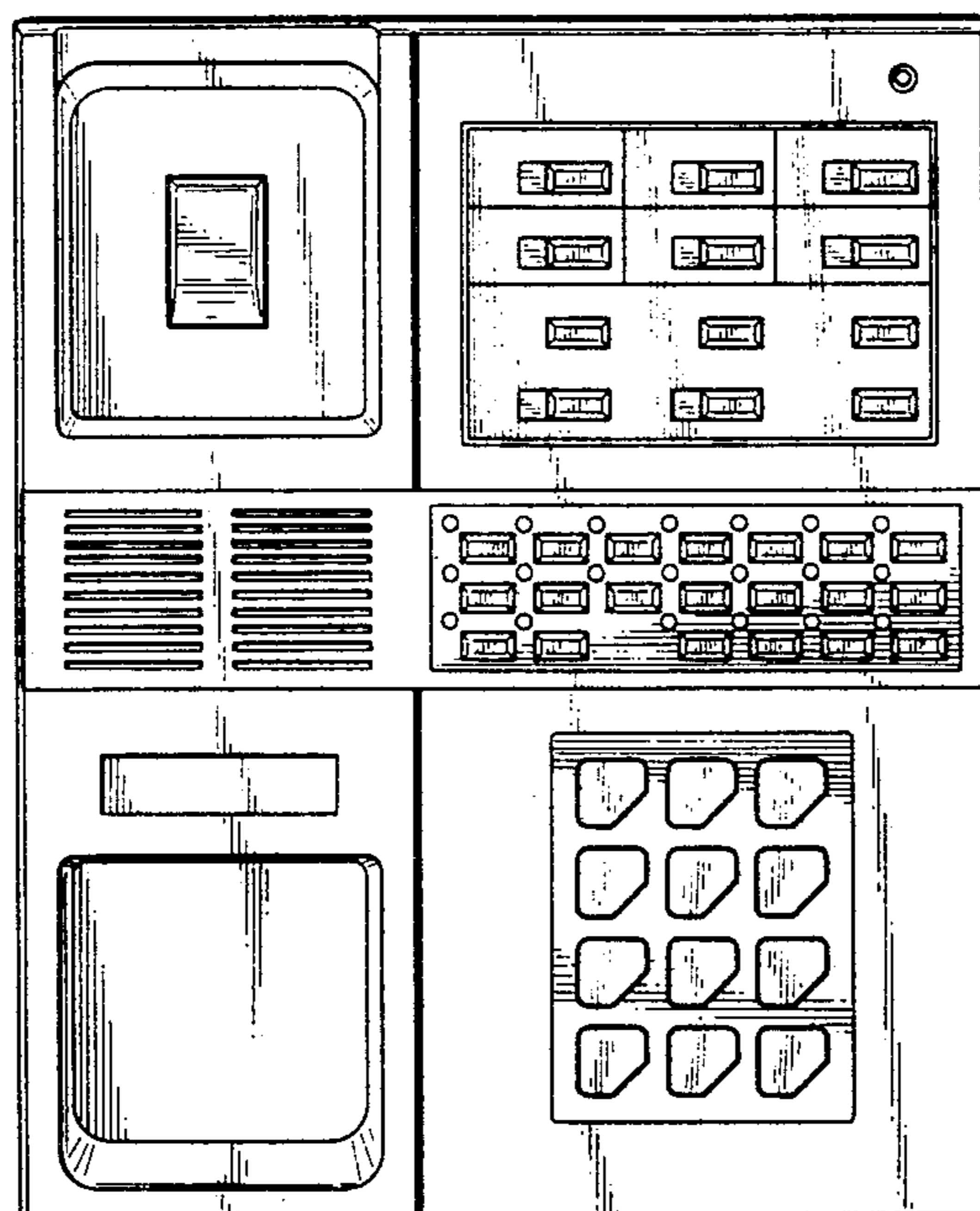

FIG.14

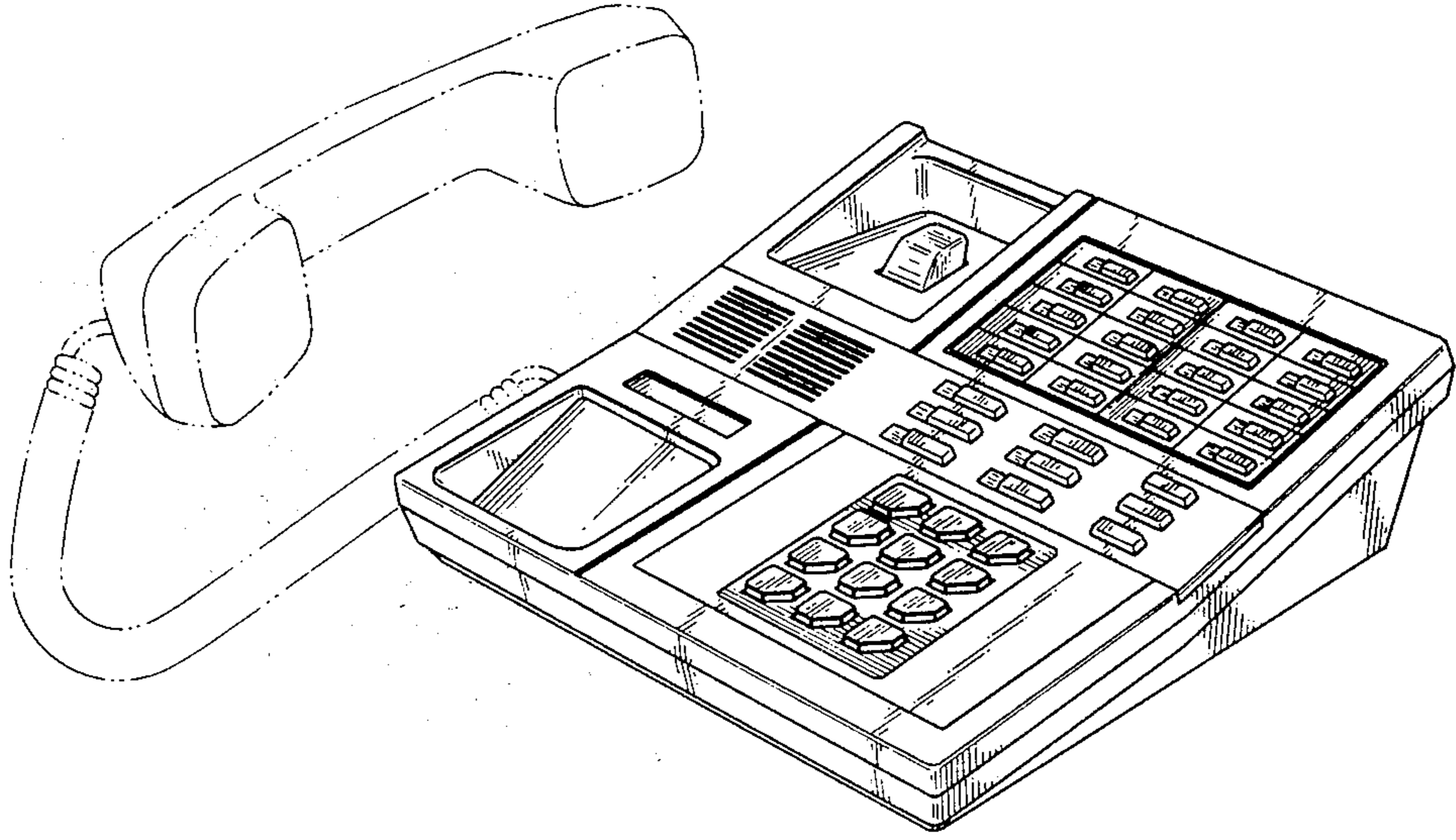

FIG.15

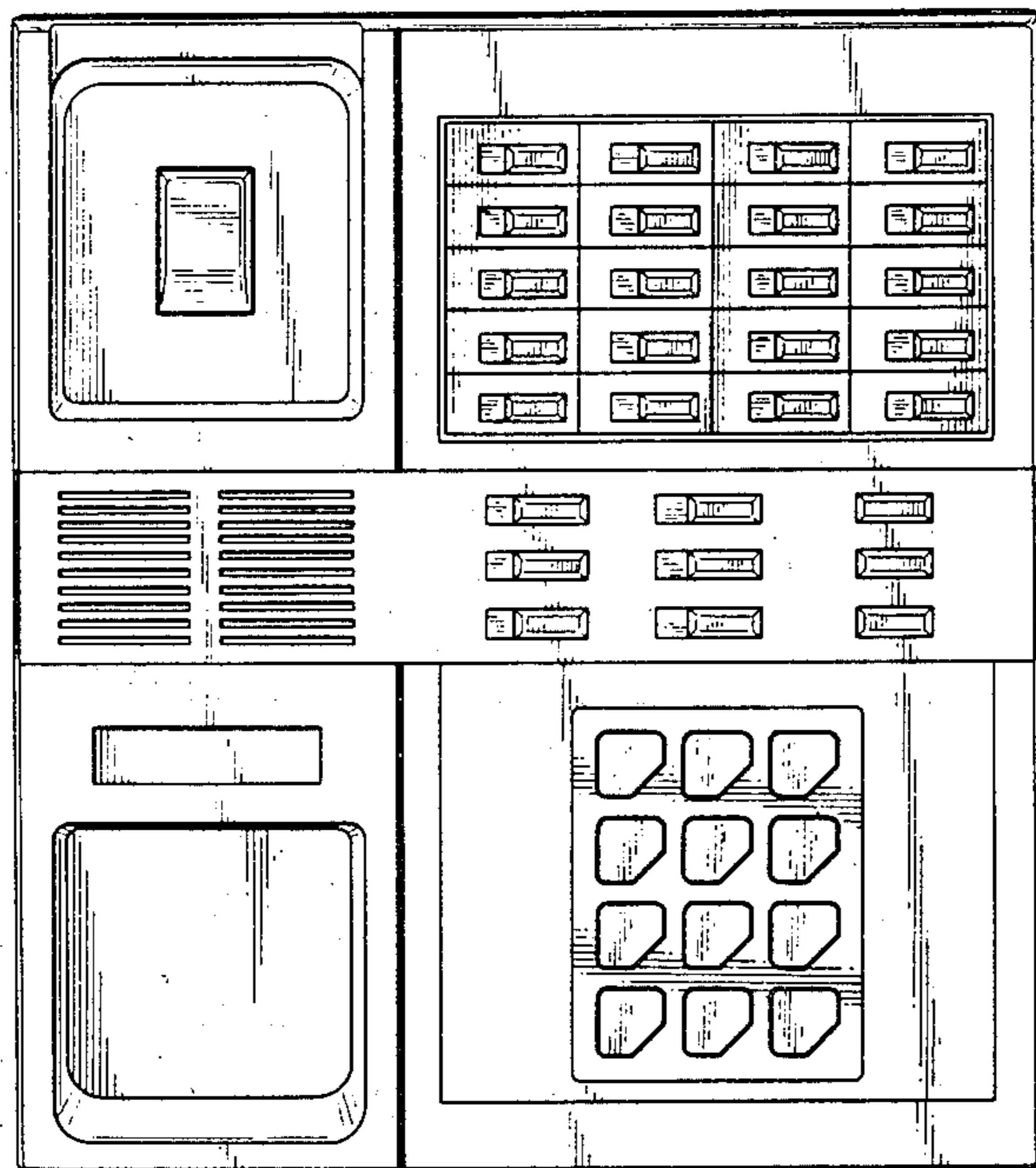

FIG. 16

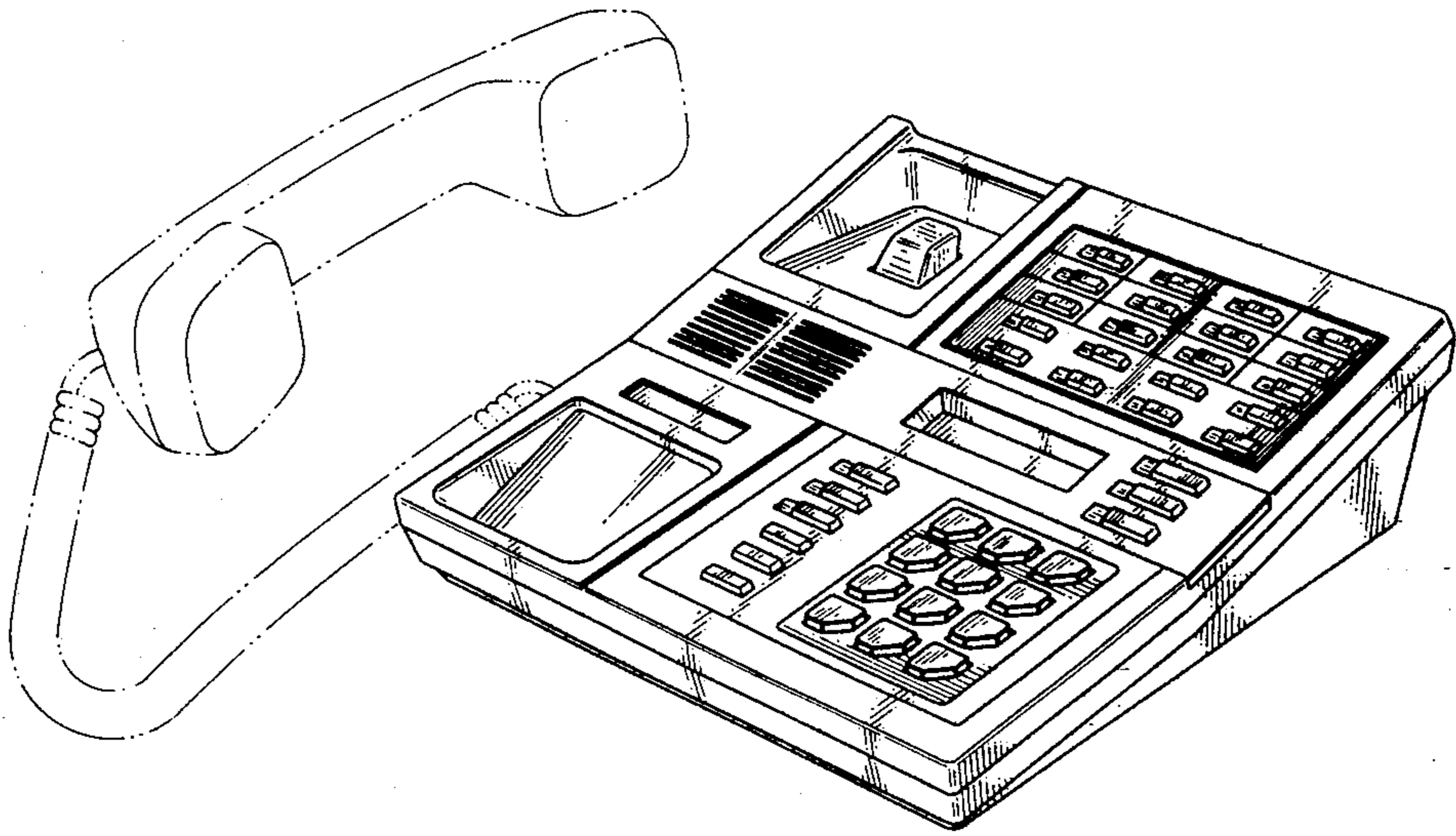

FIG. 17

