

[54] STORAGE AND DISPLAY CONTAINER FOR FLOPPY DISKETTES

[75] Inventors: Jerry M. Long, Pleasanton; James A. Womack, Los Gatos, both of Calif.

[73] Assignee: Innovative Concepts, Inc., San Jose, Calif.

[**] Term: 14 Years

[21] Appl. No.: 611,843

[22] Filed: May 18, 1984

[52] U.S. Cl. D3/35; D3/78; D19/76

[58] Field of Search D3/35, 78; D19/76, 75, D19/89, 90; D9/341, 420, 422; 206/387, 472, 444, 425; 40/371

[56] References Cited
U.S. PATENT DOCUMENTS

D. 181,514 11/1957 Blod D9/420

D. 202,935 11/1965 Braun D9/420
D. 243,526 3/1977 Overman D3/78
D. 267,911 2/1983 Long et al. D19/76

Primary Examiner—George P. Word
Attorney, Agent, or Firm—Hamrick, Hoffman, Guillot & Kazubowski

[57] CLAIM

The ornamental design for a storage and display container for floppy diskettes, as shown and described.

DESCRIPTION

FIG. 1 is a perspective view of a storage and display container for floppy diskettes showing our new design in closed condition;
FIG. 2 is a perspective view thereof in open condition;
FIG. 3 is a front elevational view of FIG. 1;
FIG. 4 is a left side elevational view, the right side being a mirror image thereof;
FIG. 5 is a top plan view thereof;
FIG. 6 is a bottom plan view thereof; and
FIG. 7 is a rear elevational view thereof.

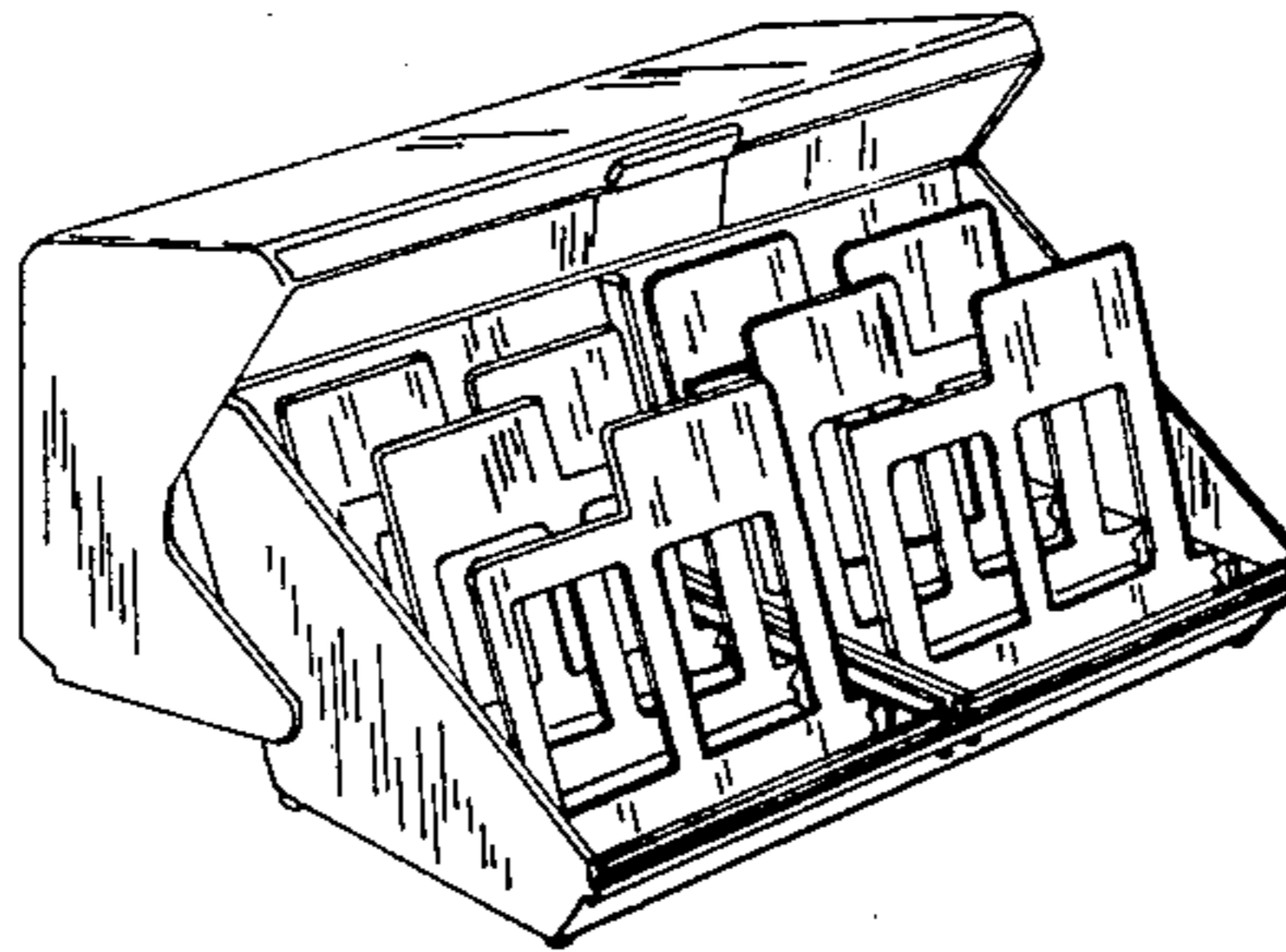
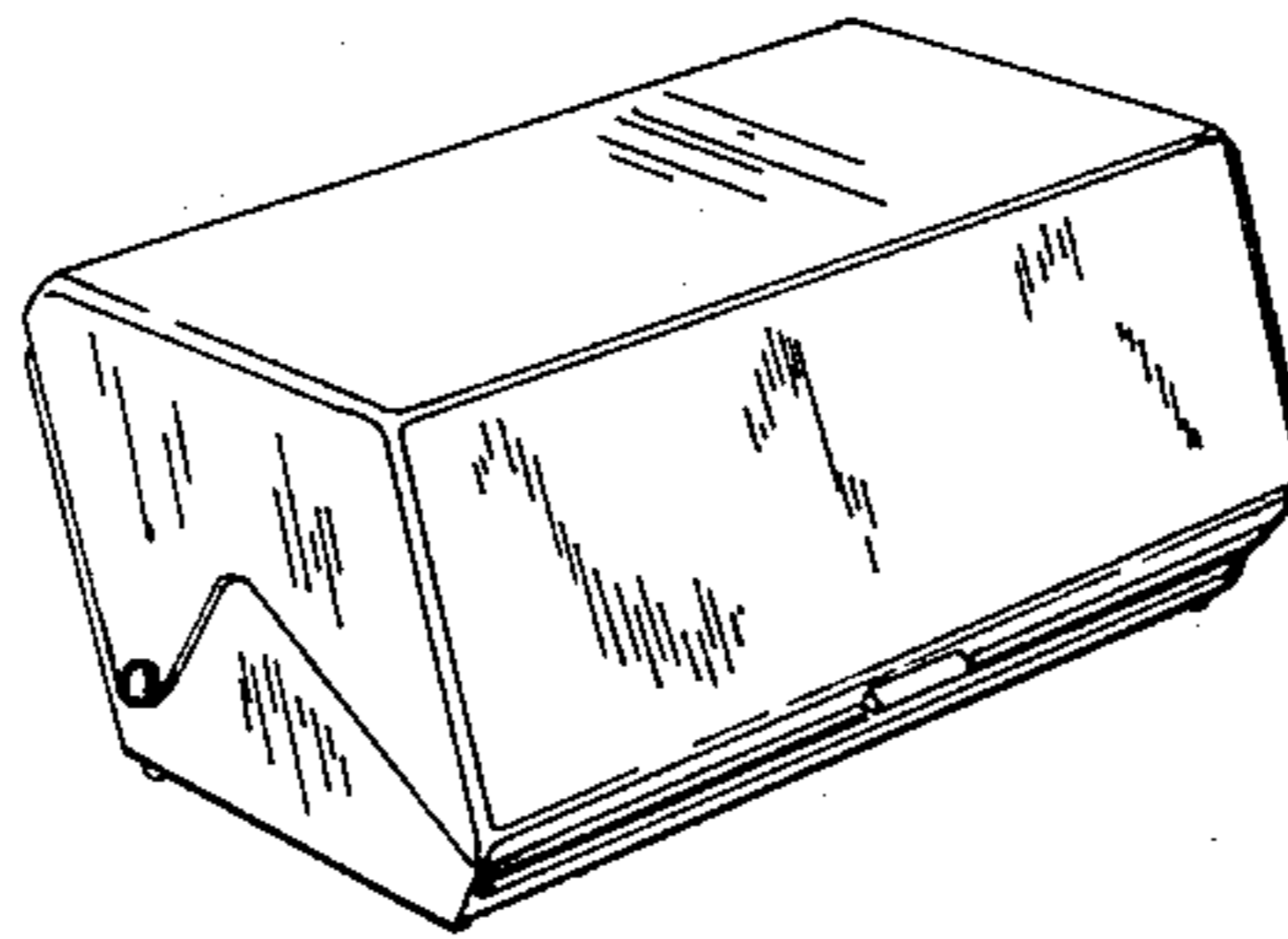

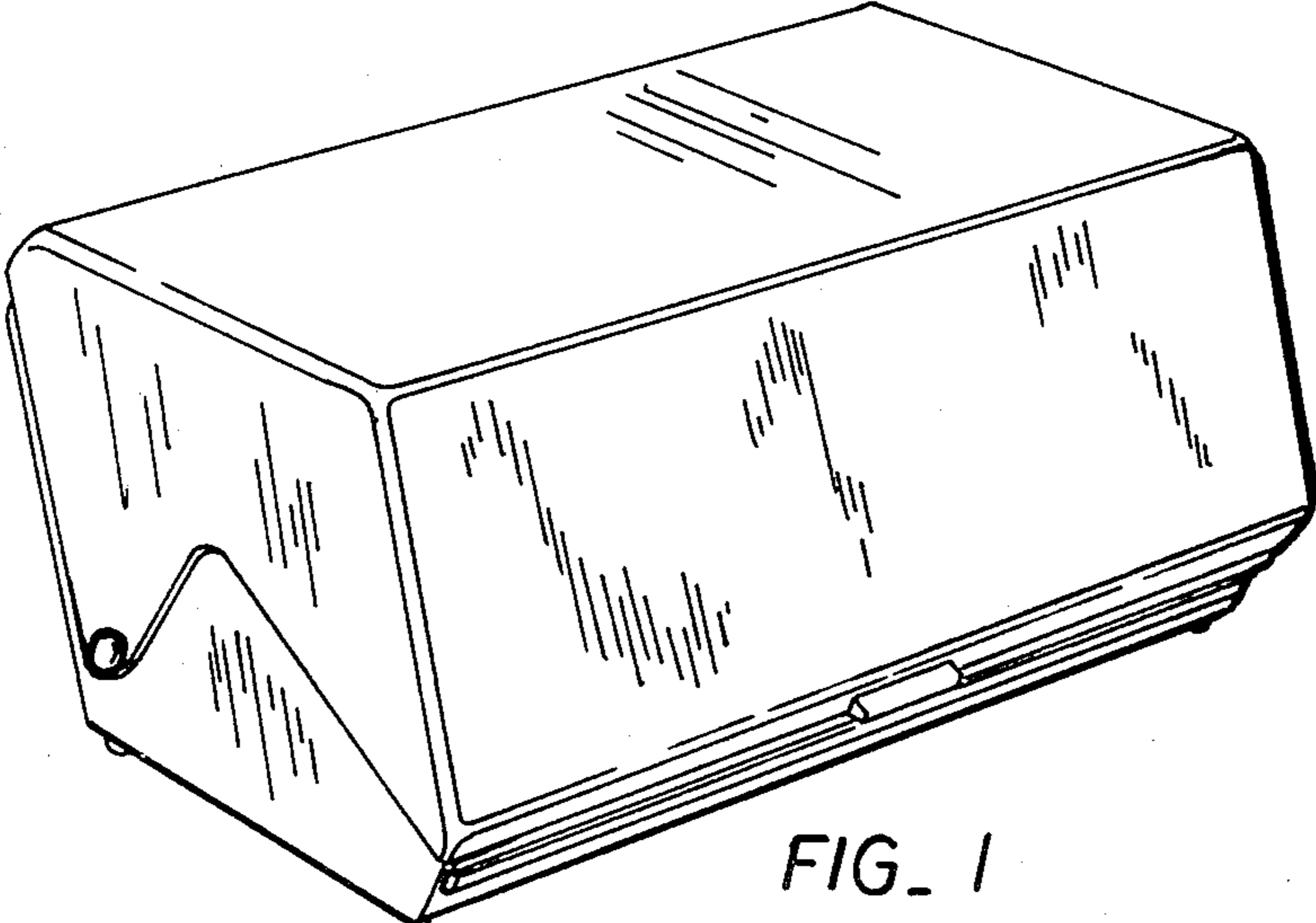

FIG. 1

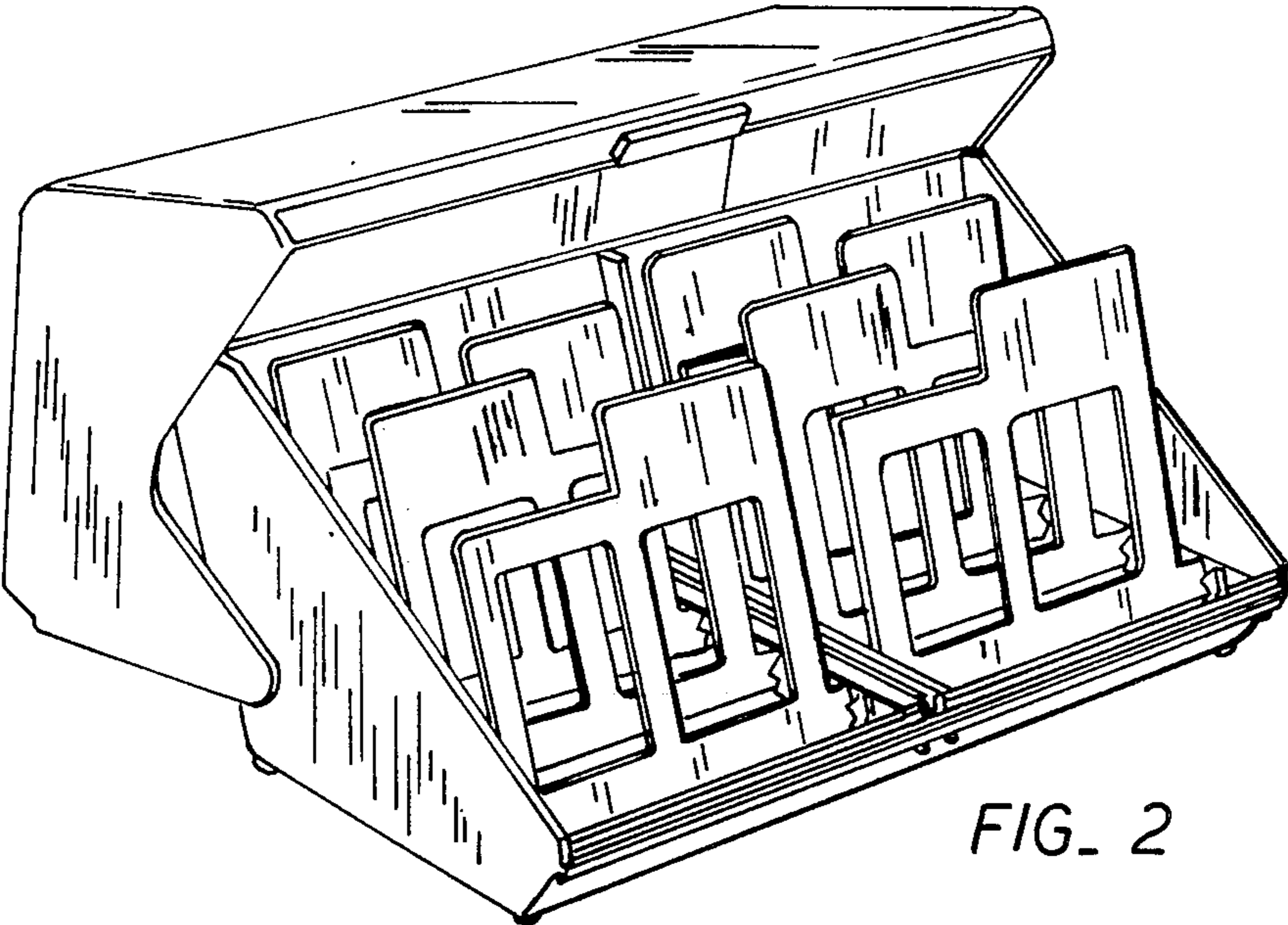

FIG. 2

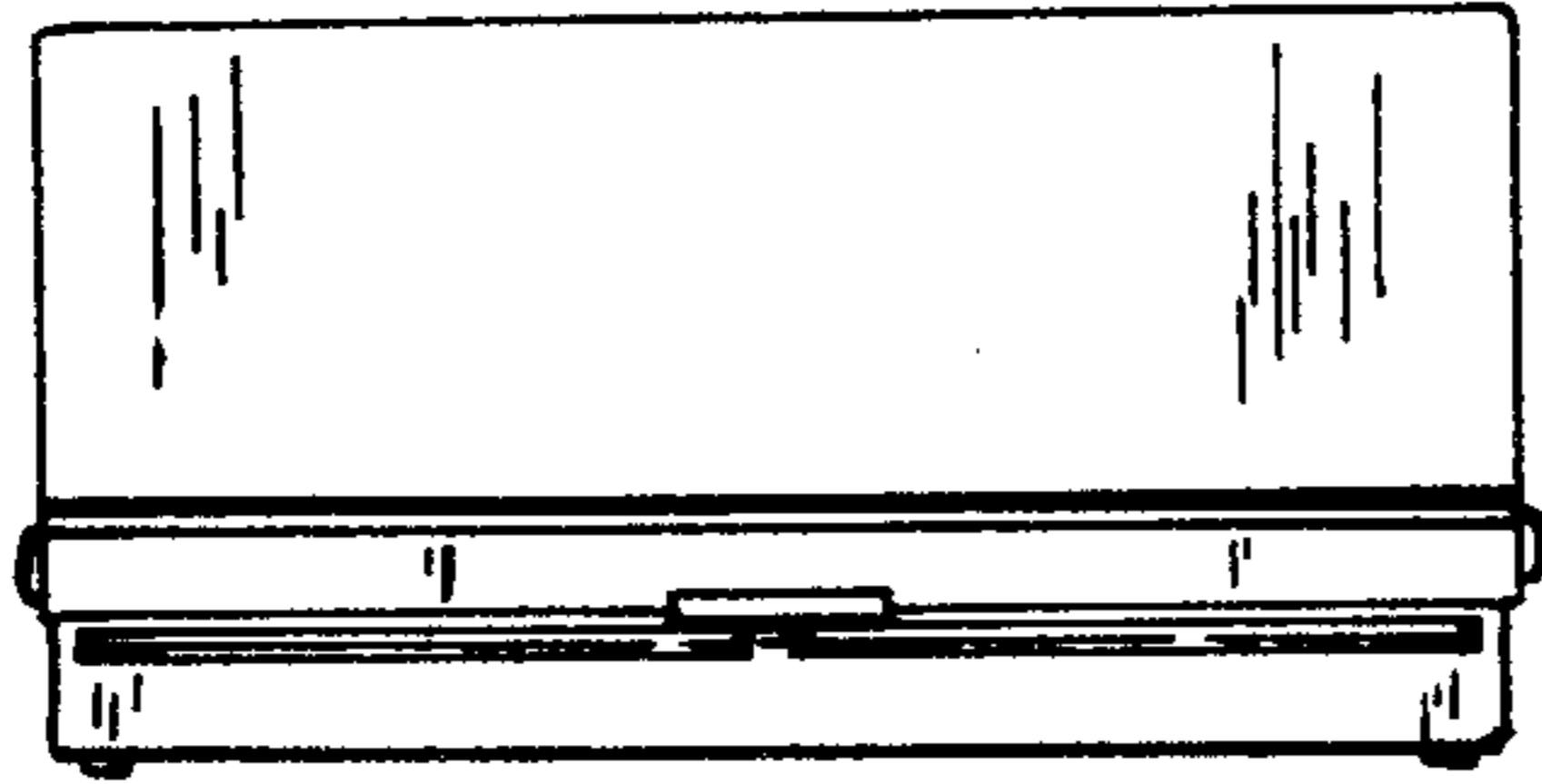

FIG. 3

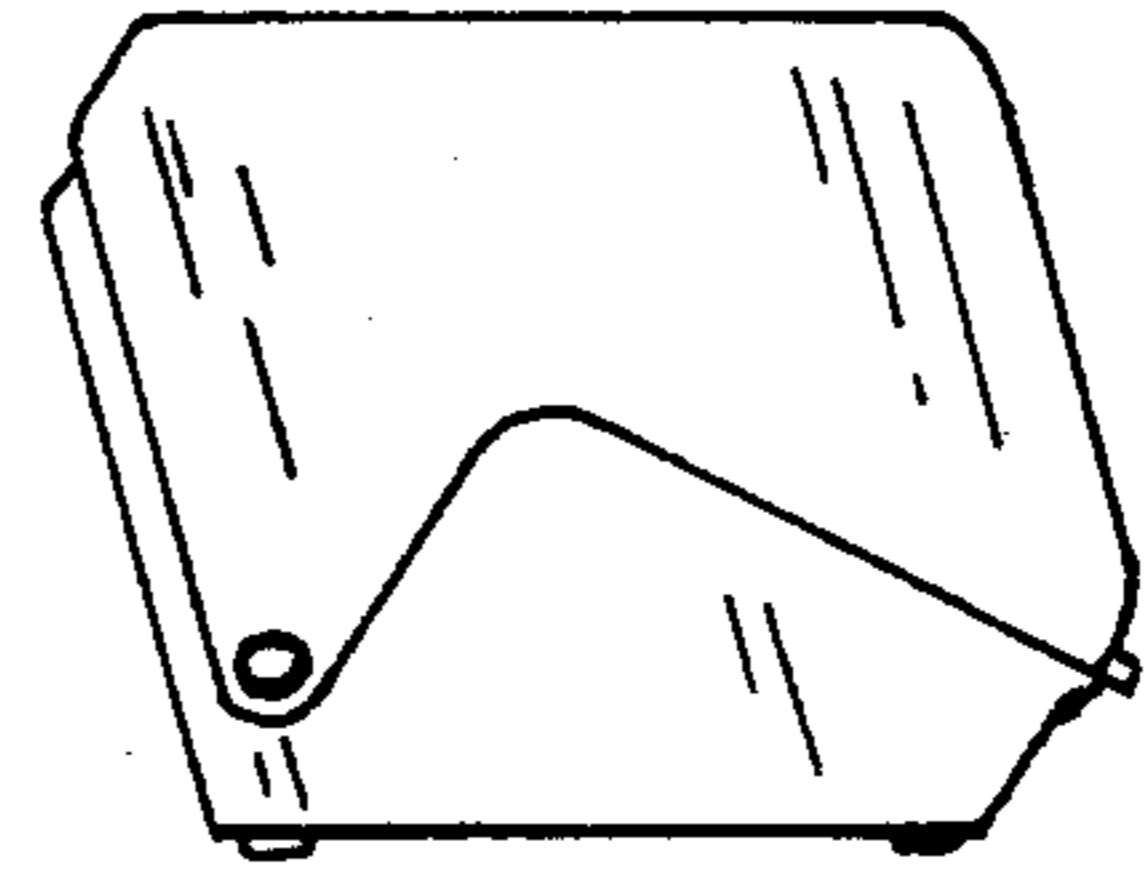

FIG. 4

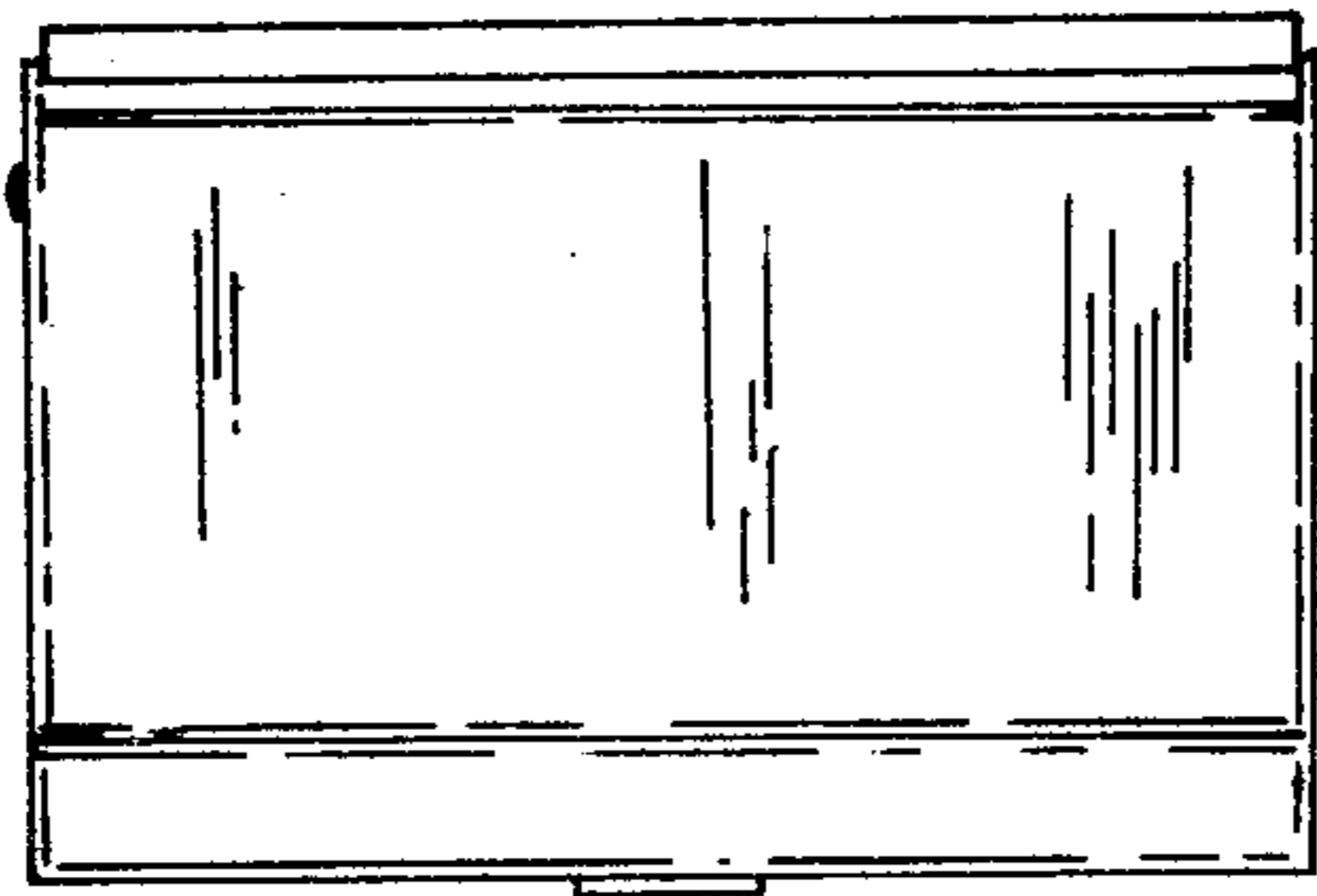

FIG. 5

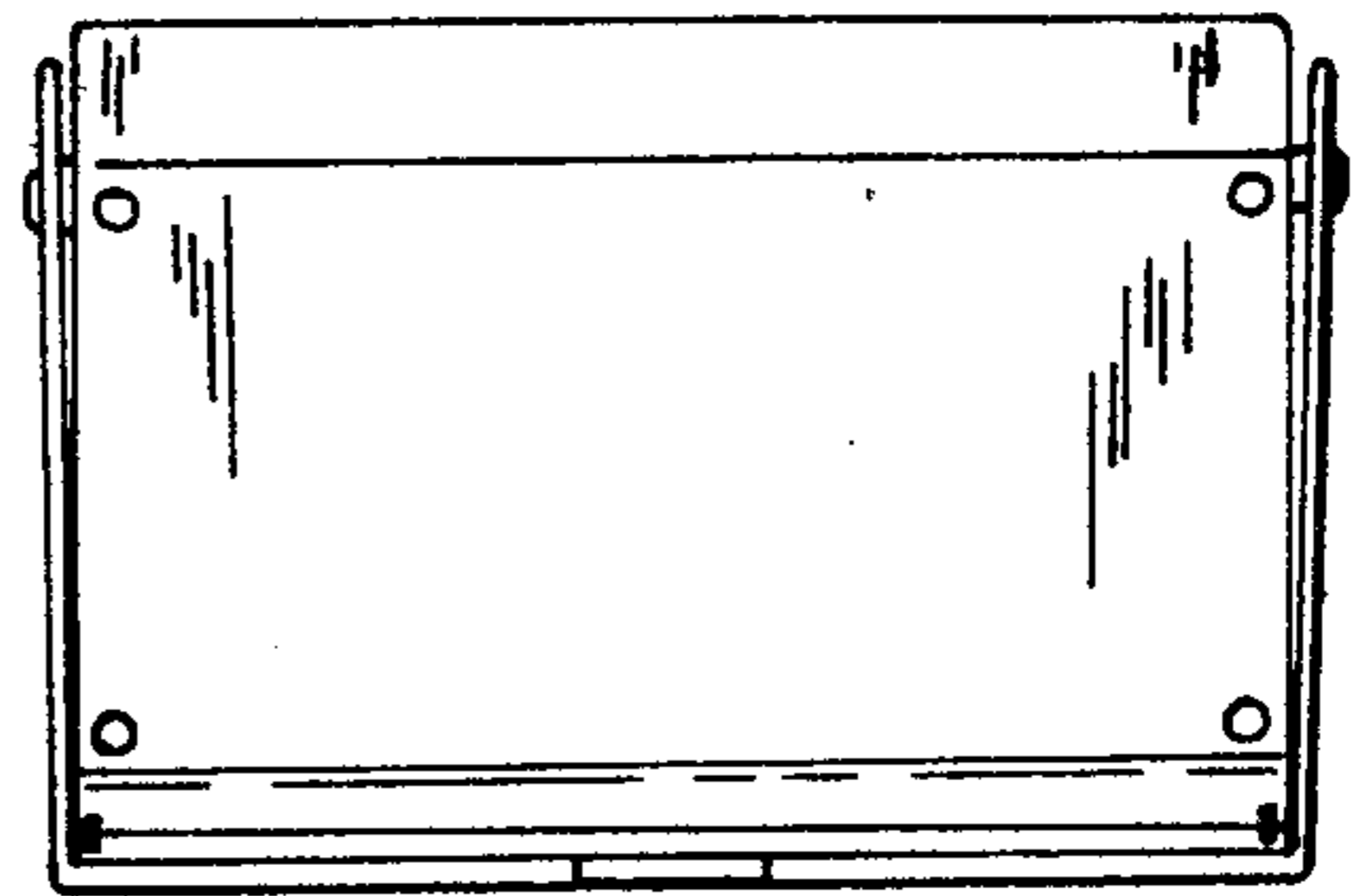

FIG. 6

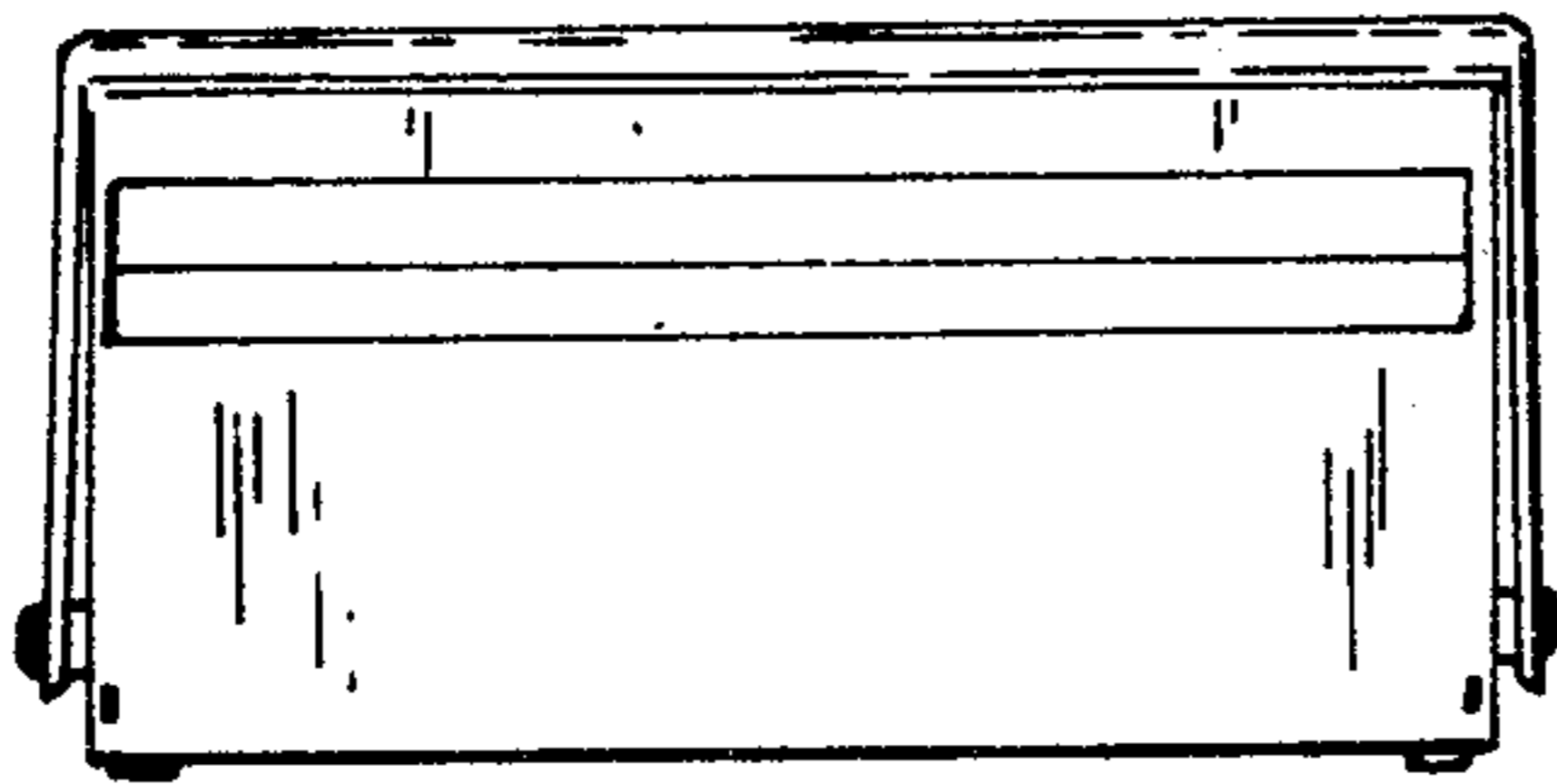

FIG. 7