

[54] TELEPHONE SET

[75] Inventors: Wilbert C. Brown, Fairfield, Conn.; Roger J. Tosto, Yorktown Heights, N.Y.; Eric K. Babbitt, Shelton; John Cuccio, Westport, both of Conn.

[73] Assignee: TIE/Communications, Inc., Shelton, Conn.

[\*] Notice: The portion of the term of this patent subsequent to Dec. 30, 2000 has been disclaimed.

[\*\*] Term: 14 Years

[21] Appl. No.: 600,132

[22] Filed: Apr. 13, 1984

[52] U.S. Cl. D14/53; D14/58; D14/62

[58] Field of Search D14/52, 53, 56, 58, D14/60, 62, 63; D21/111; 179/179, 100 R, 100 D, 100 L, 102, 103, 101

[56] References Cited

U.S. PATENT DOCUMENTS

- D. 257,772 1/1981 Fukutani D14/53
- D. 265,089 6/1982 Bee D14/58

- D. 269,178 5/1983 Foggia et al. D14/53
- D. 269,674 7/1983 Hirota et al. D14/53
- D. 275,751 10/1984 Mahon D14/58
- D. 277,663 2/1985 Sakamoto D14/53
- D. 277,929 3/1985 Sakamoto et al. D14/58
- D. 278,337 4/1985 Banko D14/53
- D. 278,533 4/1985 Ando D14/62
- D. 280,404 9/1985 Inaba D14/62
- D. 280,617 9/1985 Inaba D14/53

Primary Examiner—Wallace R. Burke  
Assistant Examiner—Horace B. Fay  
Attorney, Agent, or Firm—Francis N. Carten

[57] CLAIM

The ornamental design for a telephone set, as shown and described.

DESCRIPTION

FIG. 1 is a front, top and right side perspective view of a telephone set showing our new design; FIGS. 2 and 7 are, respectively, top and bottom plan views; FIGS. 3 and 6 are, respectively, front and rear end elevational views; and FIGS. 4 and 5 are, respectively, left and right side elevational views.

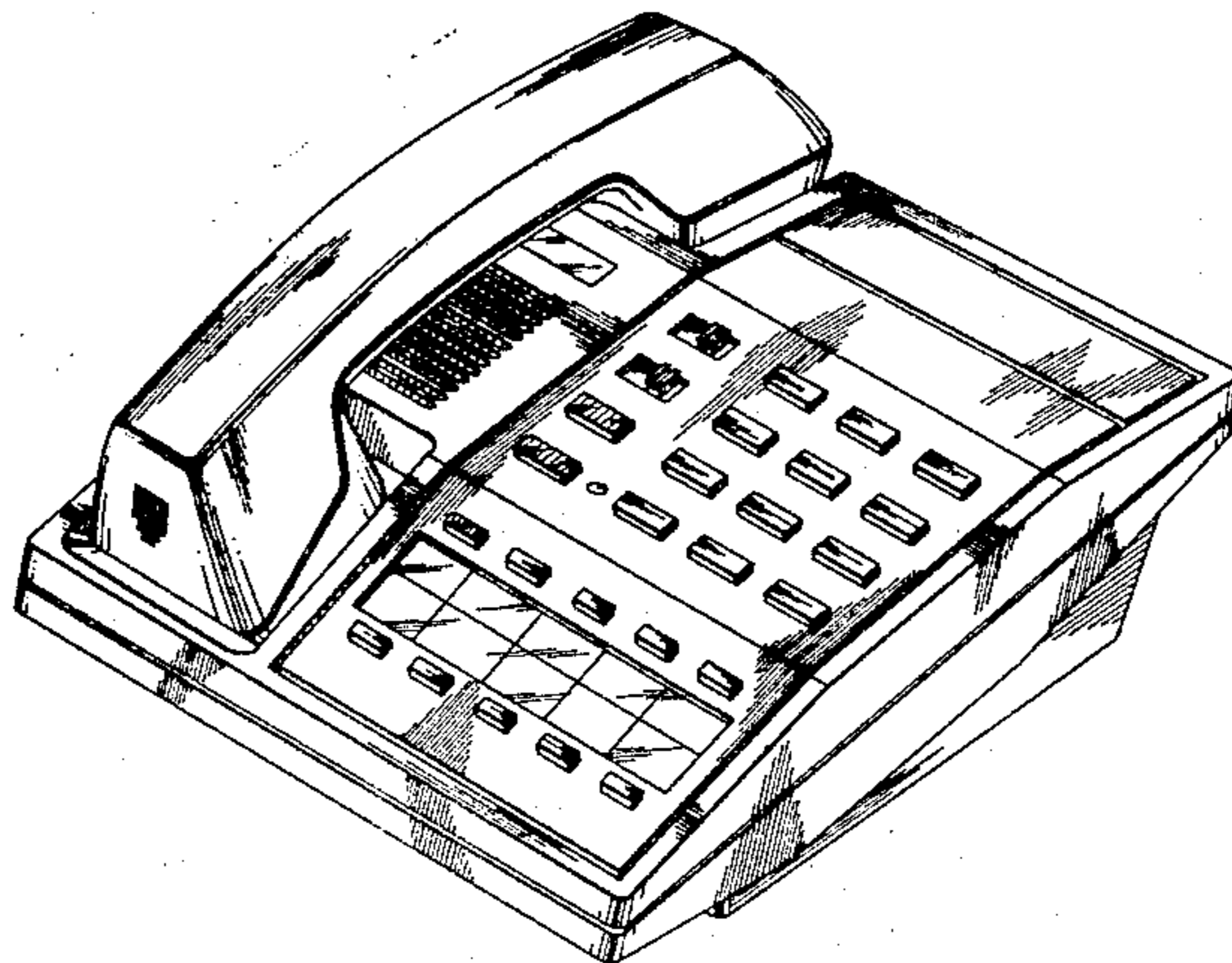
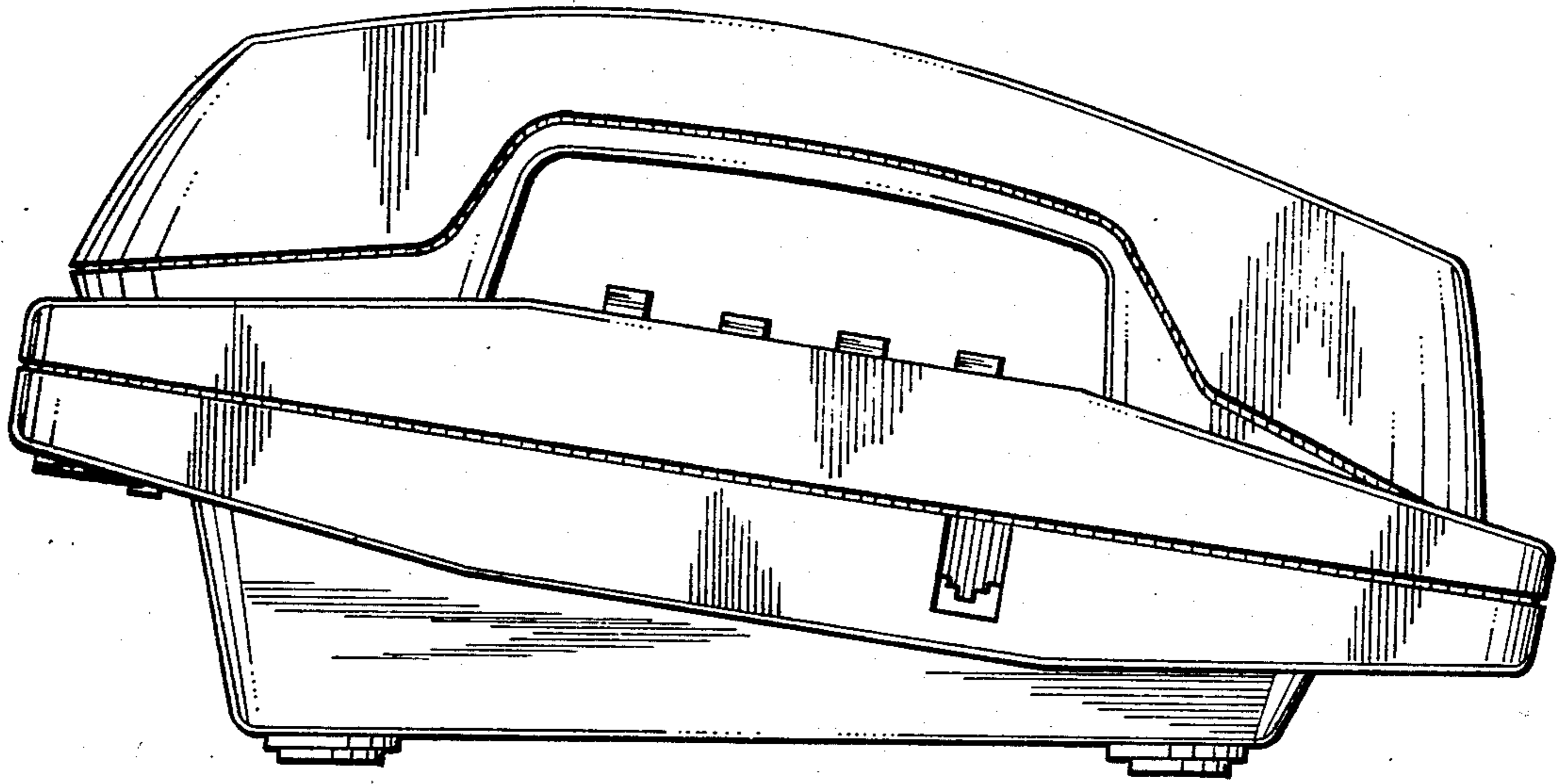

FIG. 1.

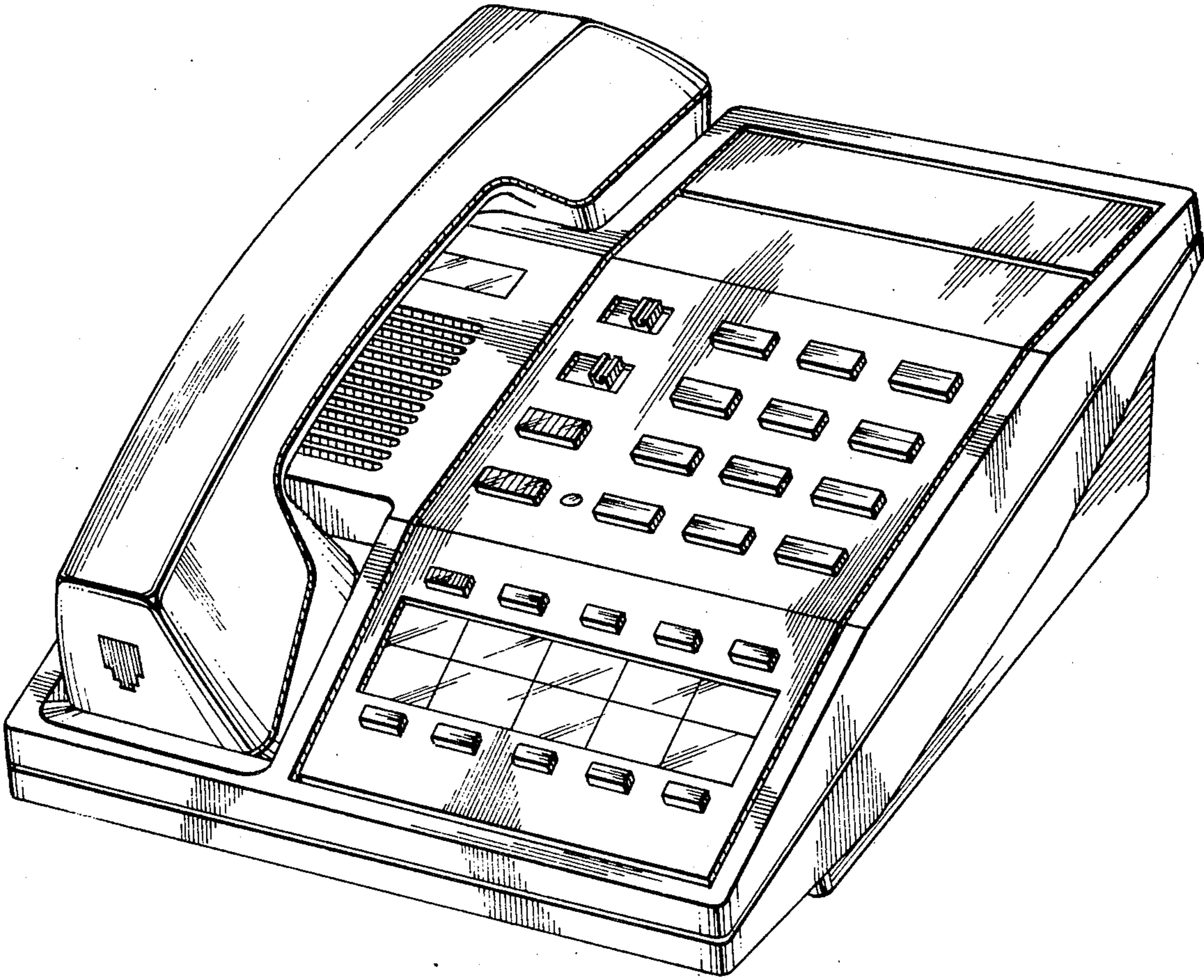

FIG. 2.

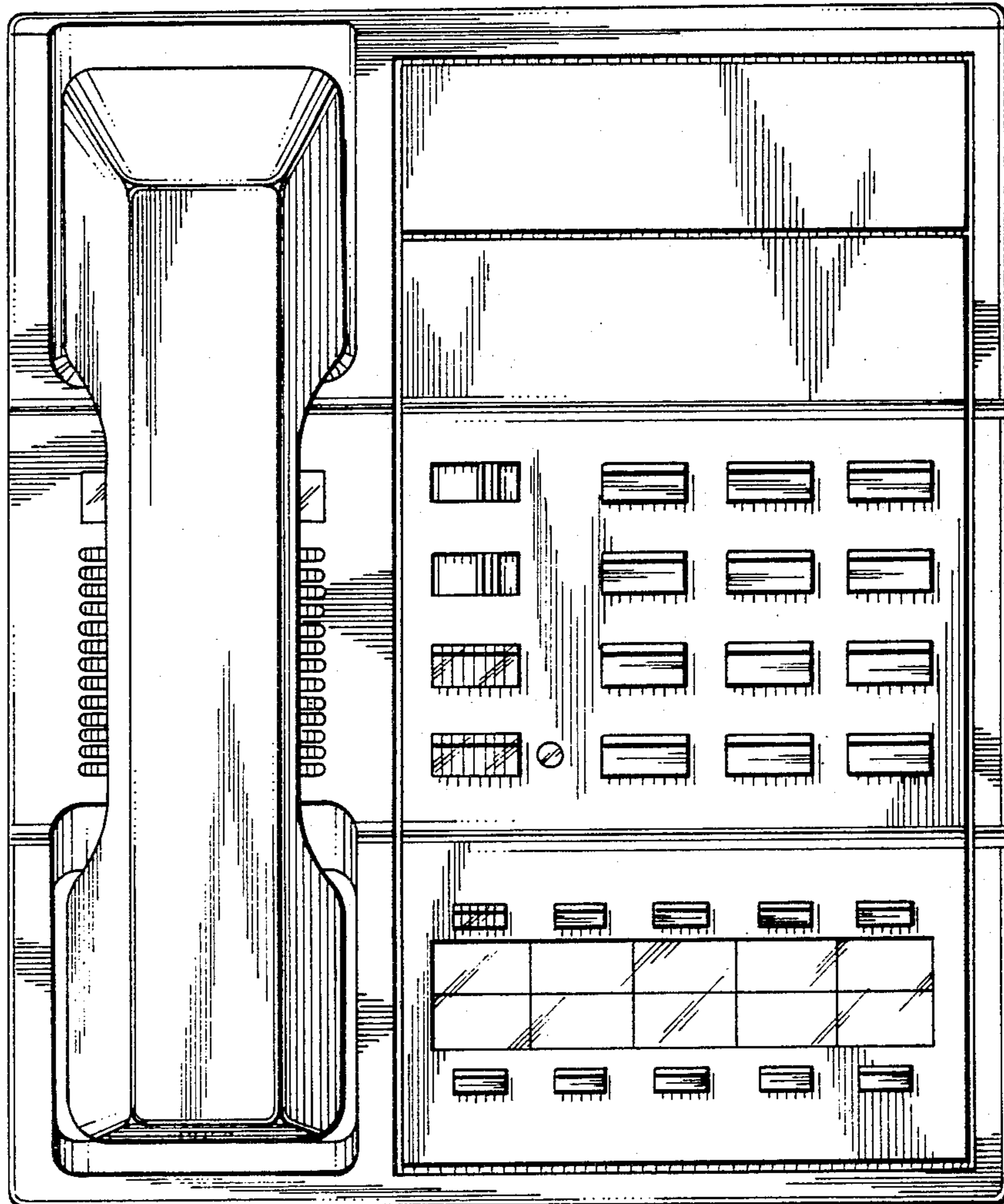

FIG. 3.

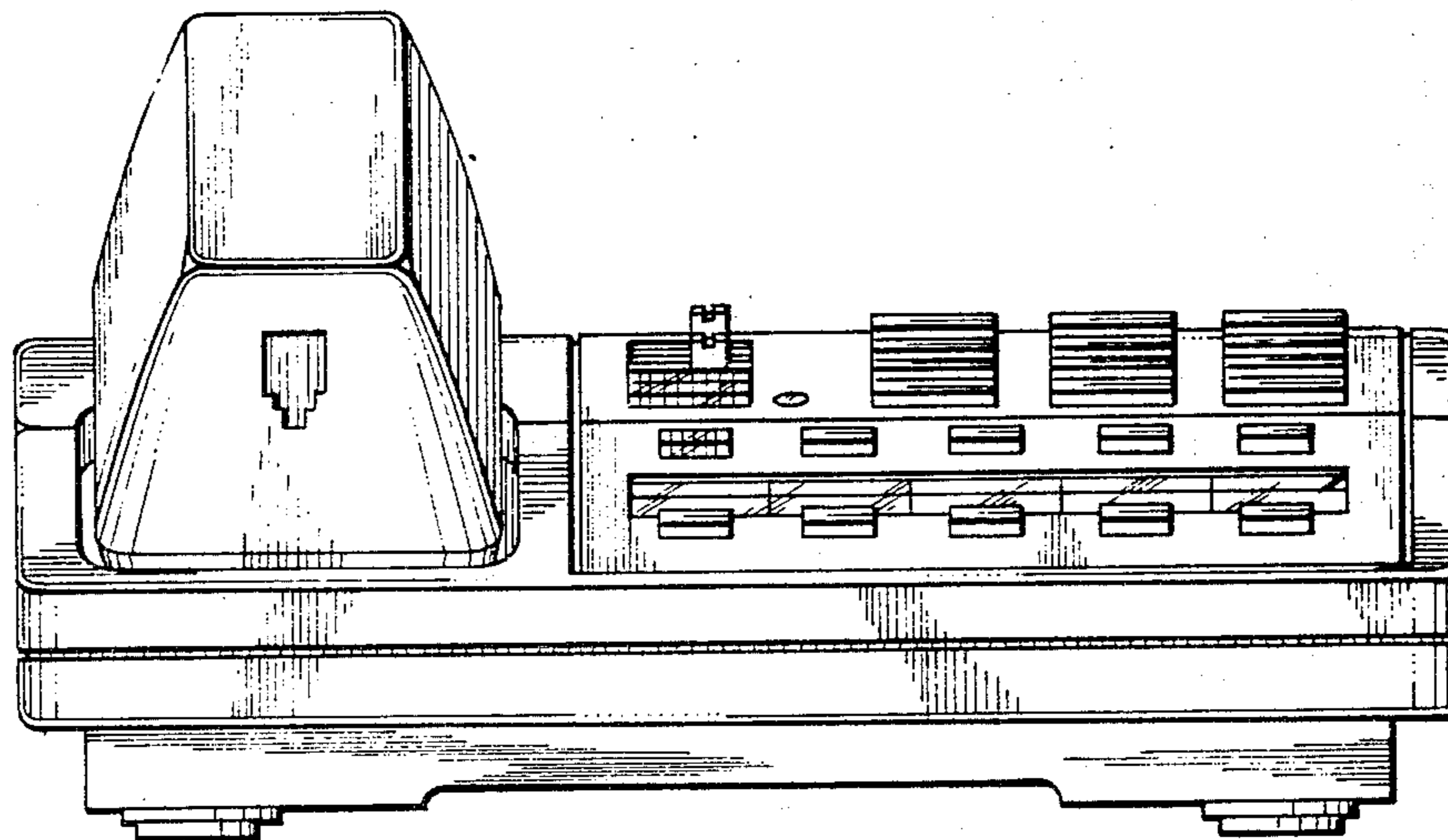

FIG. 4.

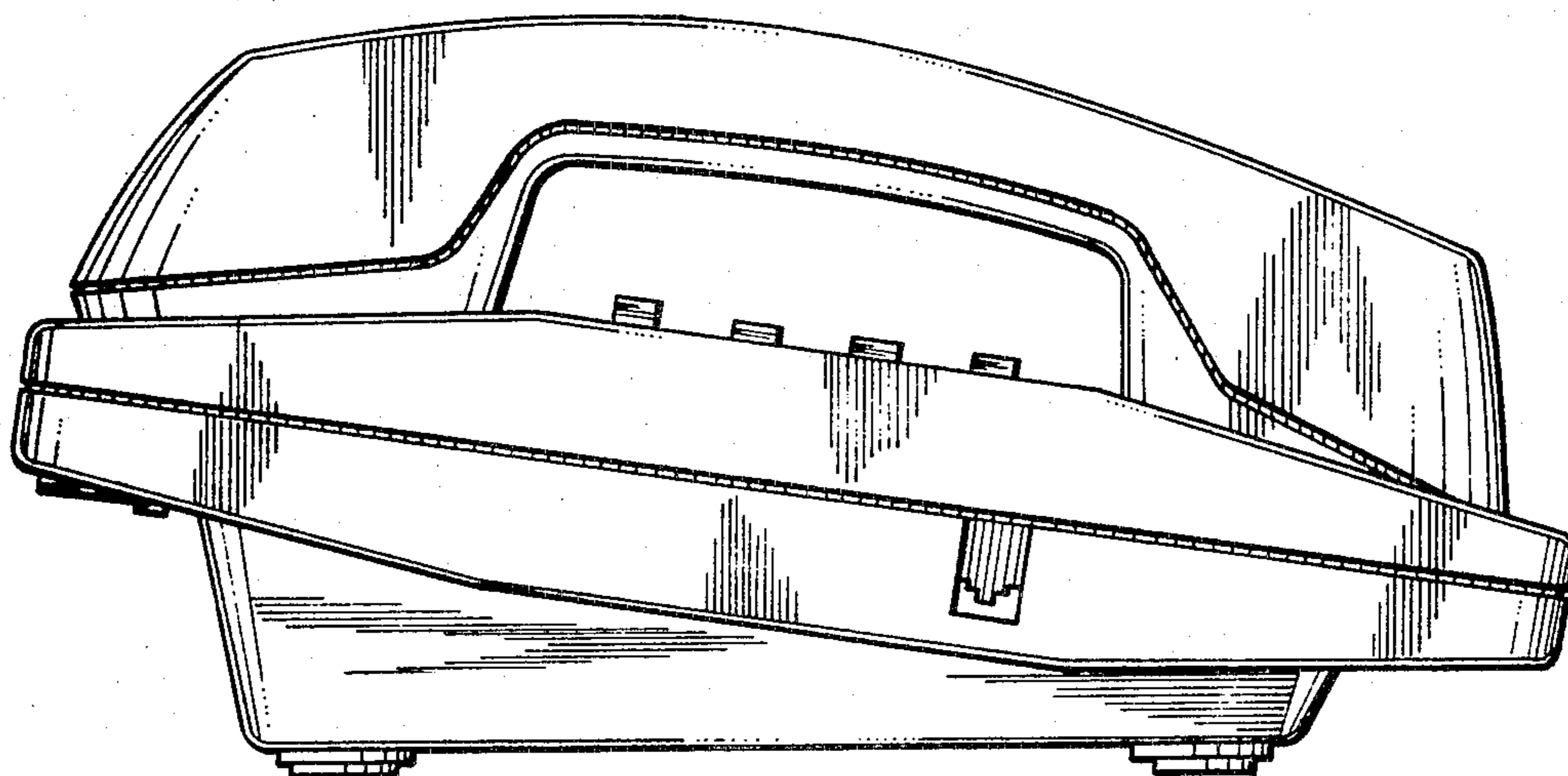

FIG. 5.

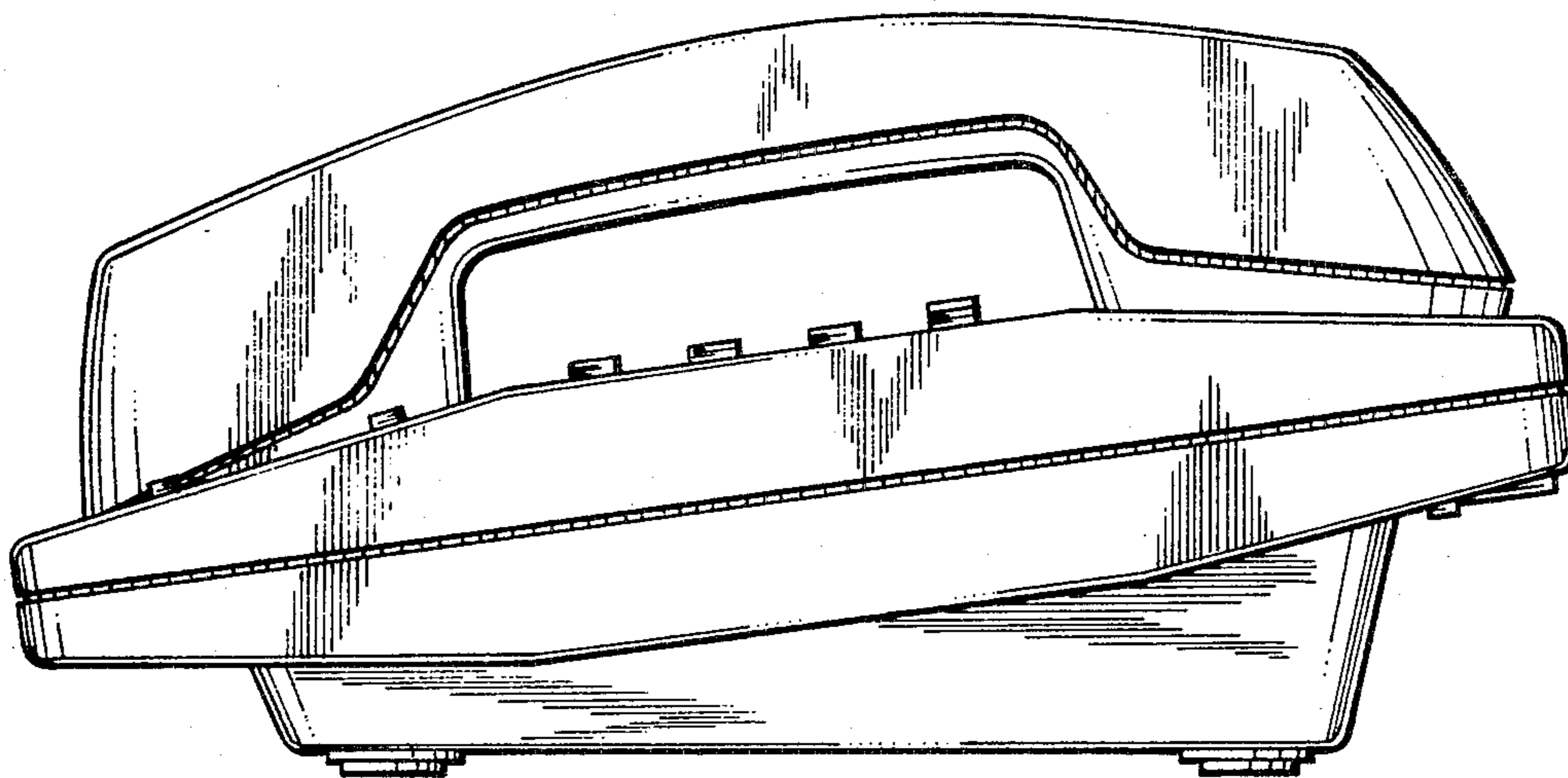

FIG. 6.

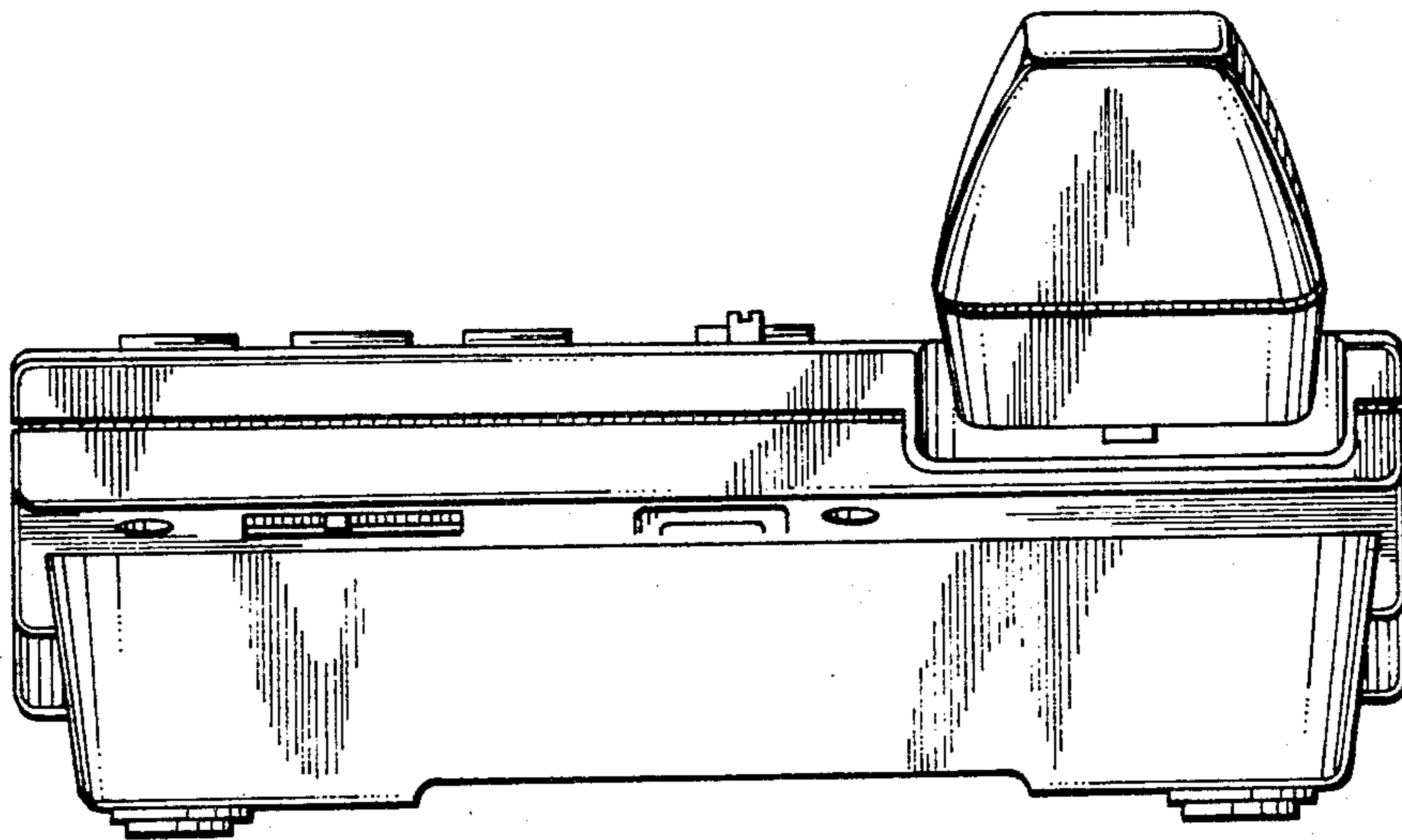

FIG. 7.

