

[54] SHELF BRACKET

[75] Inventor: John S. Shepard, Windsor, Colo.

[73] Assignee: SISU Shelving Corporation, Fort Collins, Colo.

[**] Term: 14 Years

[21] Appl. No.: 631,461

[22] Filed: Jul. 16, 1984

[52] U.S. Cl. D8/381; D6/574

[58] Field of Search D8/381, 380; 248/235, 248/240; D6/576, 572, 574

[56] References Cited

U.S. PATENT DOCUMENTS

D. 88,720	12/1932	Wiepert	D6/576
D. 164,266	8/1951	Simpson	D8/381
D. 213,569	3/1969	Paine	D8/381
D. 270,034	8/1983	Shepard	D8/381
560,884	5/1896	Anderson et al.	248/235
883,323	3/1908	MacDuff	248/235
1,066,463	7/1913	Carl	248/235
1,279,416	9/1918	Osborne	248/250
3,400,829	9/1968	Youngson	248/235
4,385,565	5/1983	Roberts et al.	248/235

4,508,301 4/1985 Nicholson et al. 248/250

FOREIGN PATENT DOCUMENTS

546838 9/1922 France 248/250

Primary Examiner—Wallace R. Burke
Assistant Examiner—Horace B. Fay
Attorney, Agent, or Firm—Hugh H. Drake

[57] CLAIM

The ornamental design of a shelf bracket, as shown and described.

DESCRIPTION

FIG. 1 is a left side elevational view of a shelf bracket showing my new design;
FIG. 2 is a right side elevational view thereof;
FIGS. 3 and 4 are respectively front and rear elevational views thereof;
FIGS. 5 and 6 are respectively top and bottom plan views thereof;
FIG. 7 is a left side, top and partial front perspective view thereof, the side opposite to that shown being a mirror image; and
FIG. 8 is a right bottom, right side and partial rear perspective view thereof, the side opposite to that shown being a mirror image.

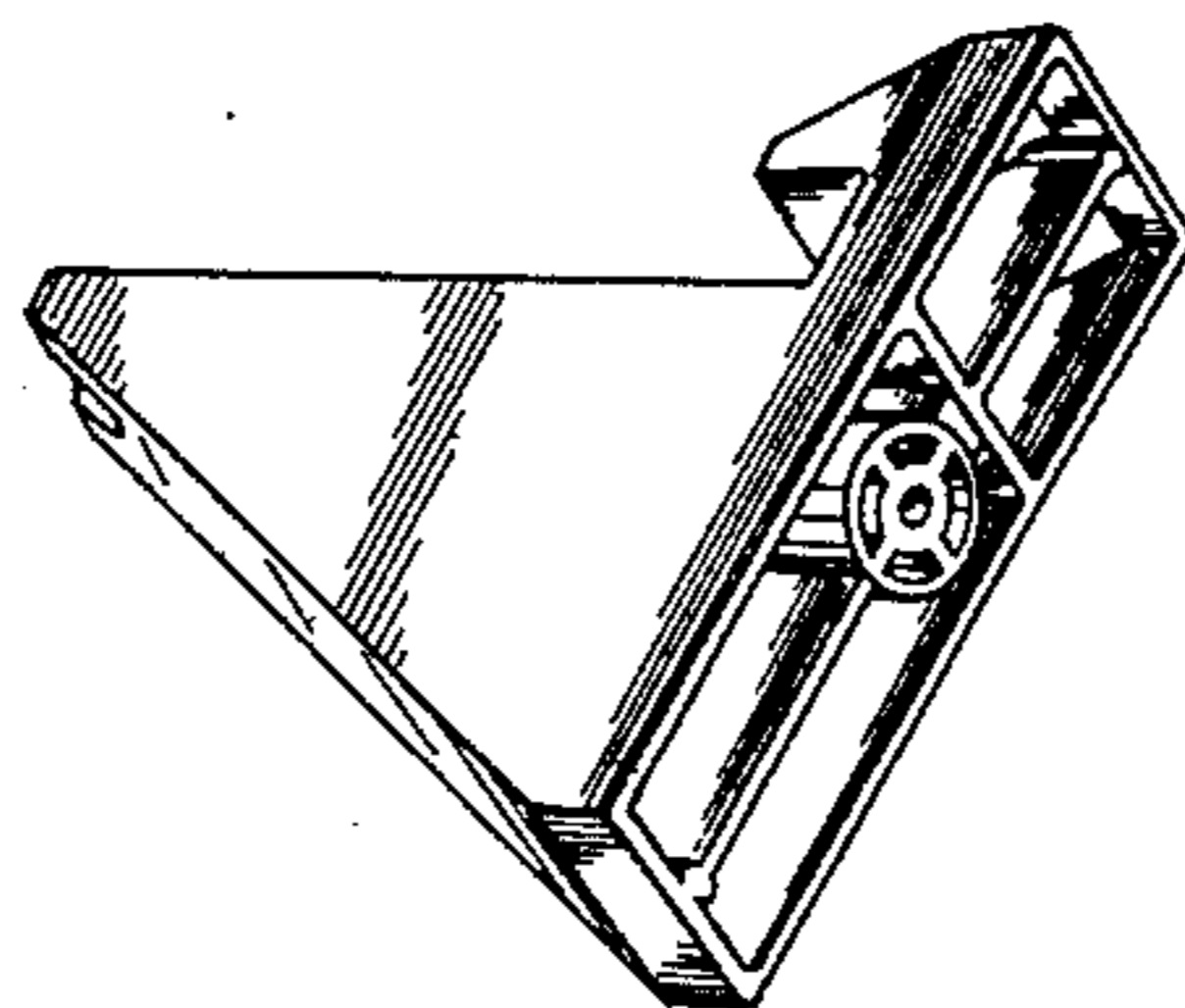
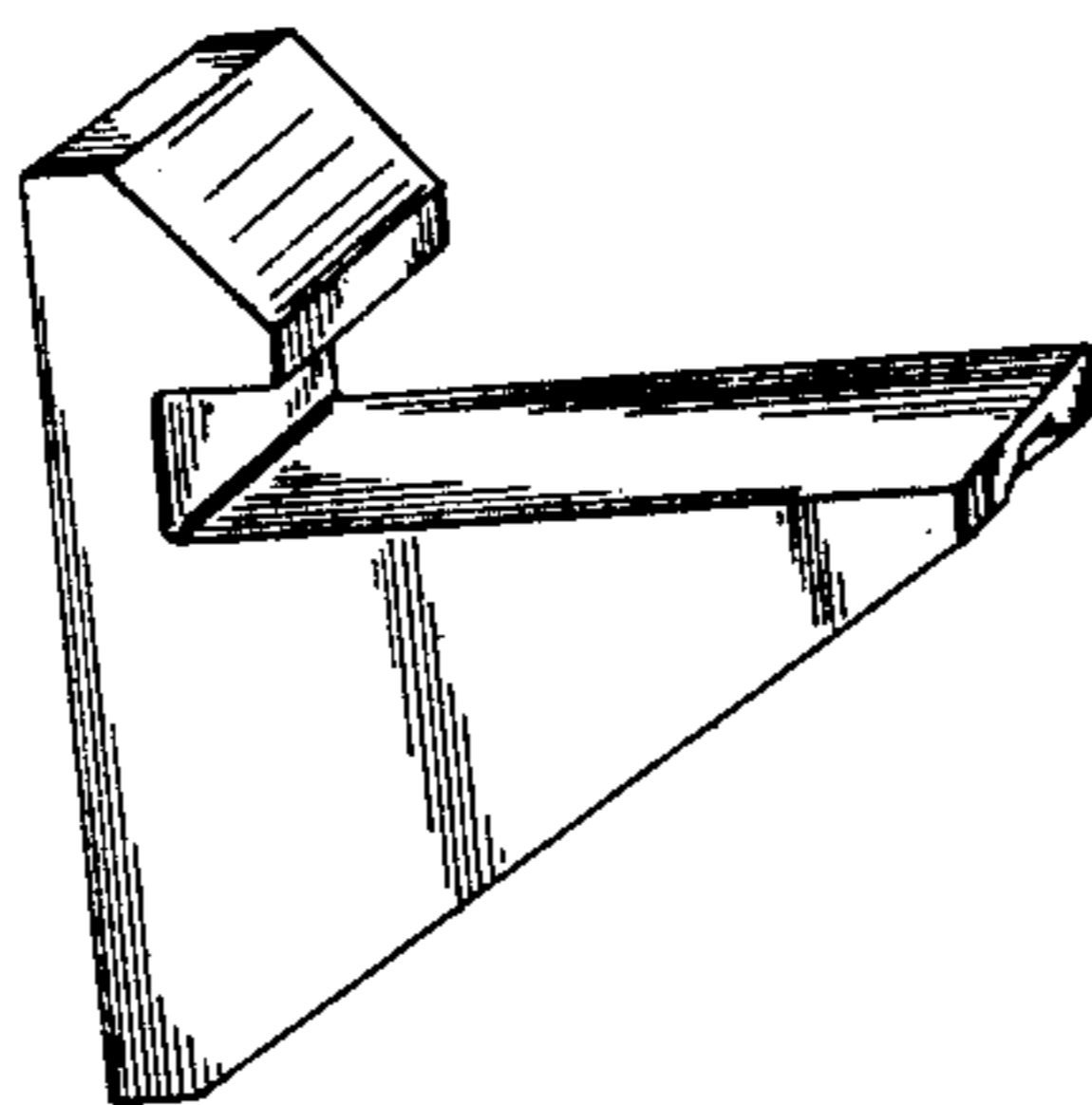

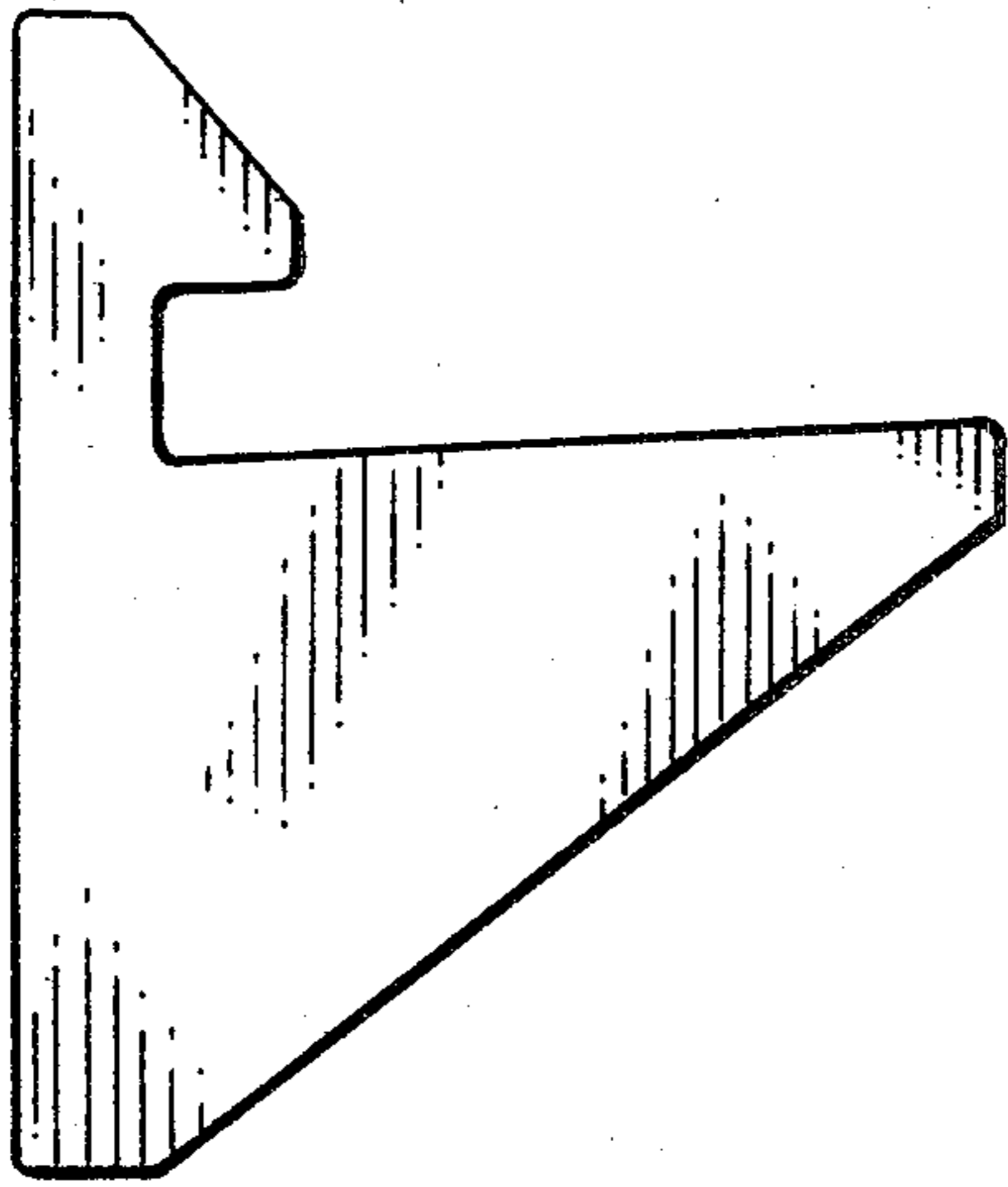

FIG. 1

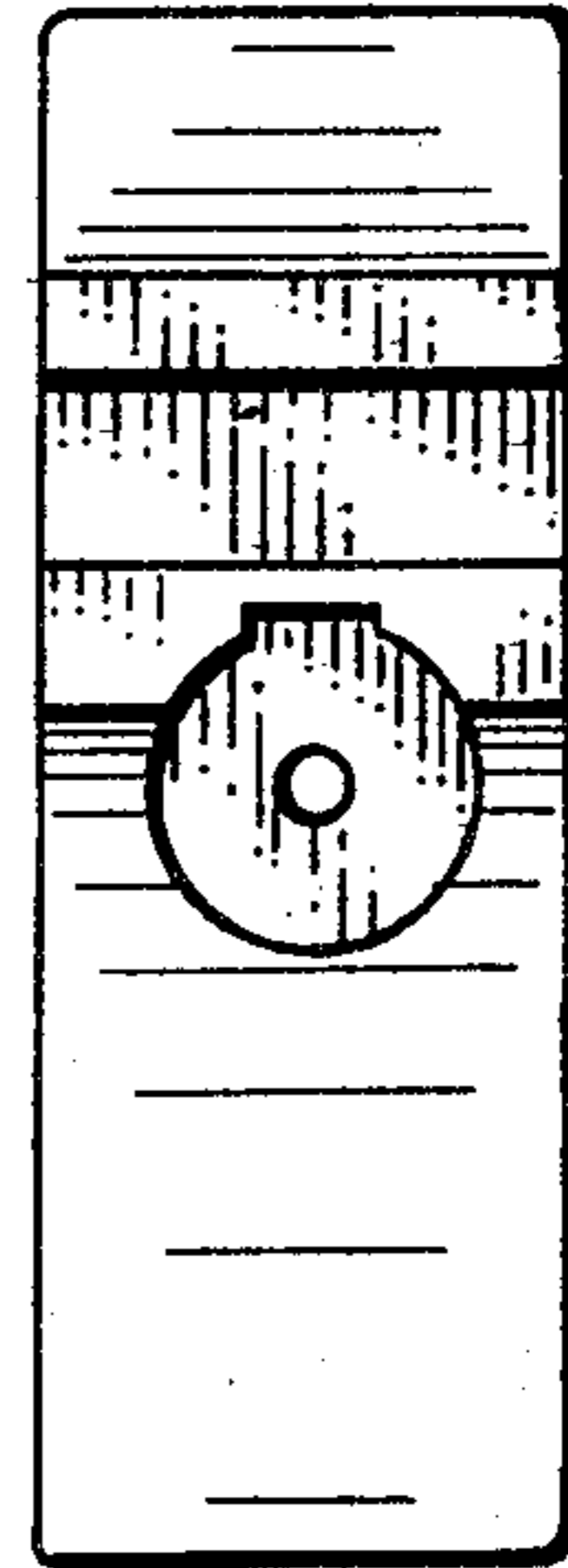

FIG. 3

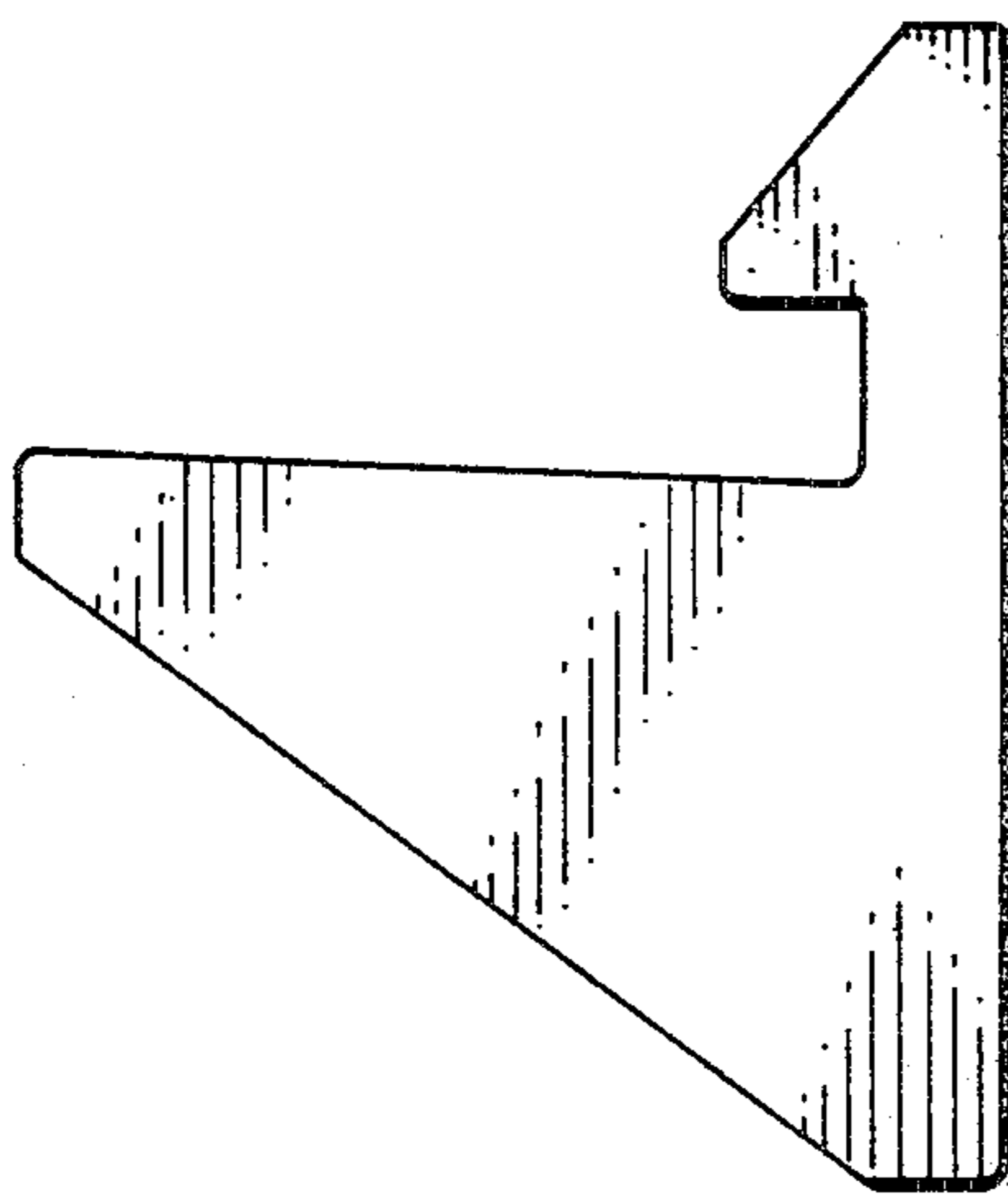

FIG. 2

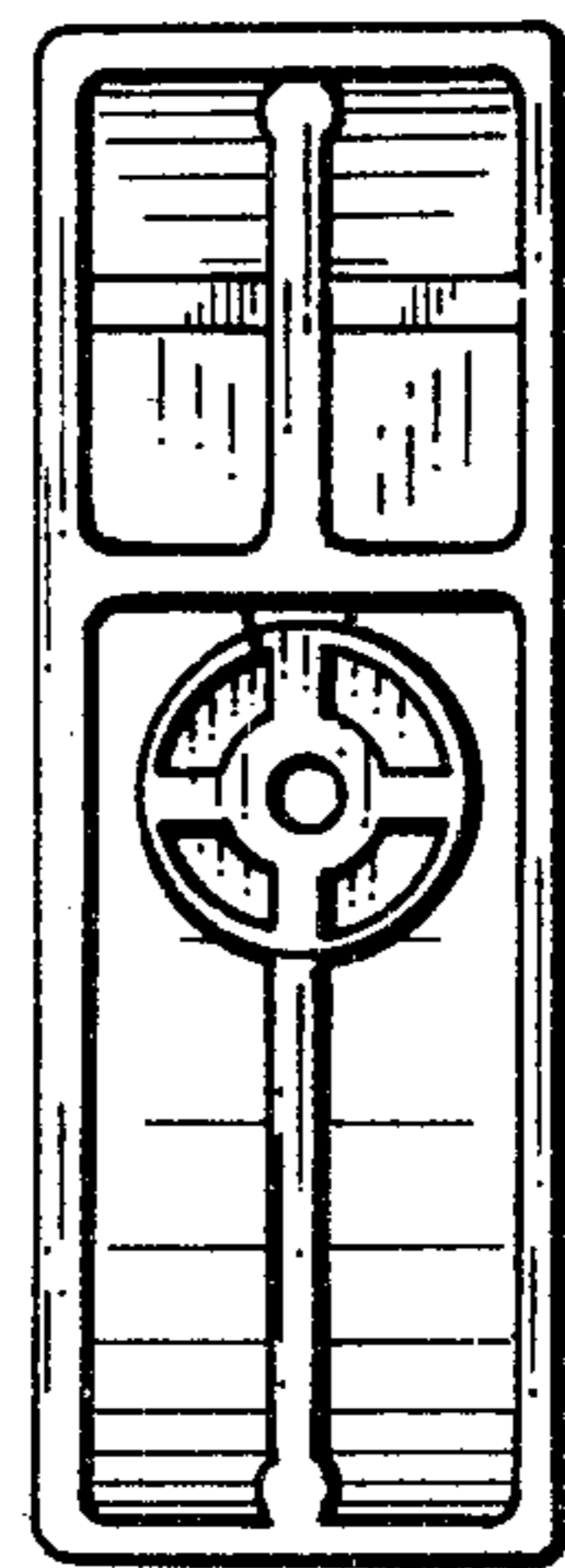

FIG. 4



FIG. 5

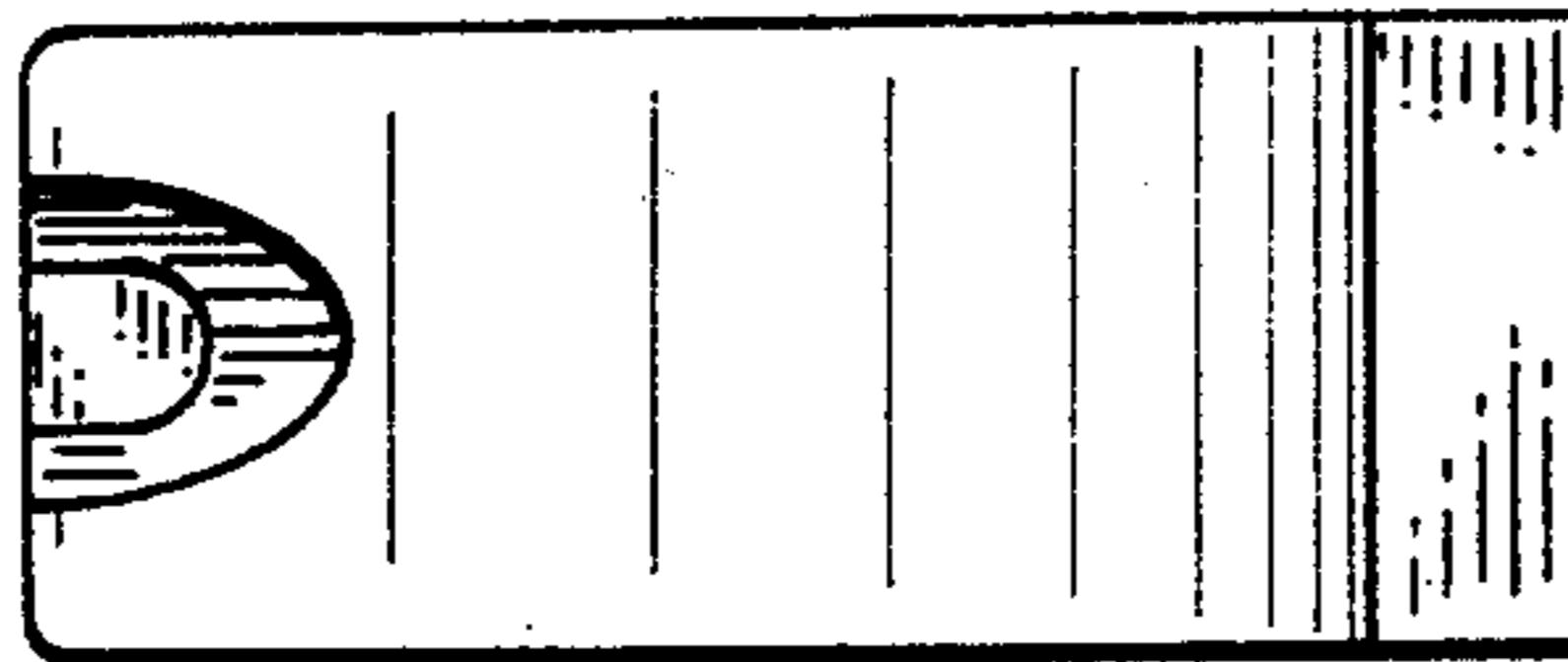

FIG. 6

FIG. 7

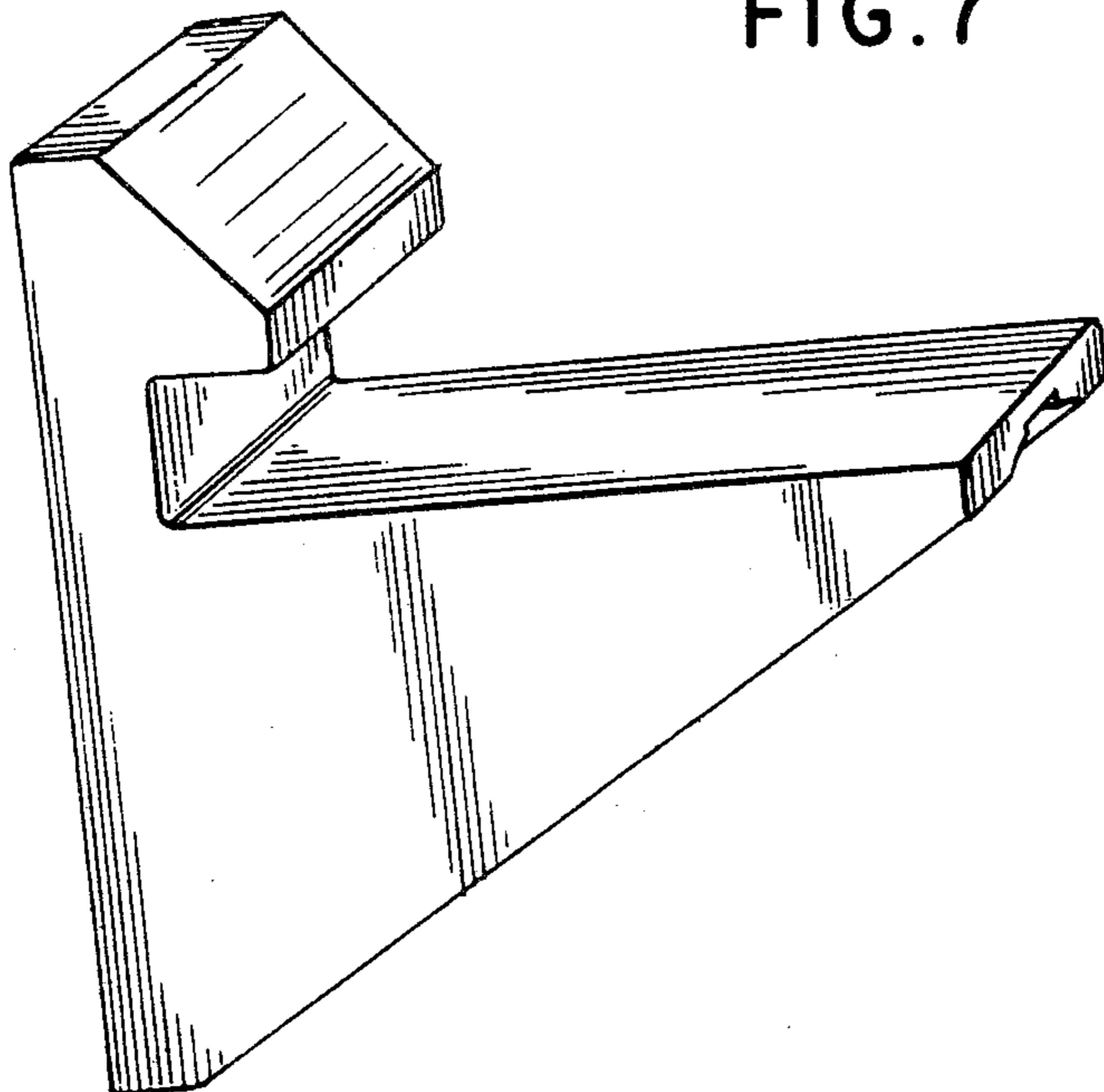

FIG. 8

