

[54] DISKETTE STORAGE CONTAINER FOR FLOPPY DISKETTES

3,253,871 5/1966 Karper D19/76
4,498,583 2/1985 Long et al. 206/425

[75] Inventors: Jerry M. Long, Pleasanton; James A. Womack, Los Gatos, both of Calif.

[73] Assignee: Innovative Concepts, Inc., San Jose, Calif.

[**] Term: 14 Years

[21] Appl. No.: 611,908

[22] Filed: May 18, 1984

[52] U.S. Cl. D3/35; D3/78; D19/76

[58] Field of Search D3/35, 78; D19/75, 76, D19/89, 90; D9/341, 420, 422; 206/387, 472, 444, 425; 40/371; 312/294

[56] References Cited

U.S. PATENT DOCUMENTS

- D. 181,514 11/1957 Blod D9/420
- D. 243,526 3/1977 Overman D3/78
- D. 280,041 8/1985 Long et al. D19/76
- D. 282,313 1/1986 Long et al. D3/78

OTHER PUBLICATIONS

The Drawing Board Fall 1983 Cat., p. 9, top right.

Primary Examiner—George P. Word
Attorney, Agent, or Firm—Hamrick, Hoffman, Guillot & Kazubowski

[57] CLAIM

The ornamental design for a diskette storage container for floppy diskettes, as shown and described.

DESCRIPTION

FIG. 1 is a perspective view of a diskette storage container for floppy diskettes showing our new design in closed condition;
 FIG. 2 is a perspective view thereof in open condition;
 FIG. 3 is a front elevational view of FIG. 1;
 FIG. 4 is a left side elevational view, the right side being a mirror image thereof;
 FIG. 5 is a top plan view thereof;
 FIG. 6 is a bottom plan view thereof; and
 FIG. 7 is a rear elevational view thereof.

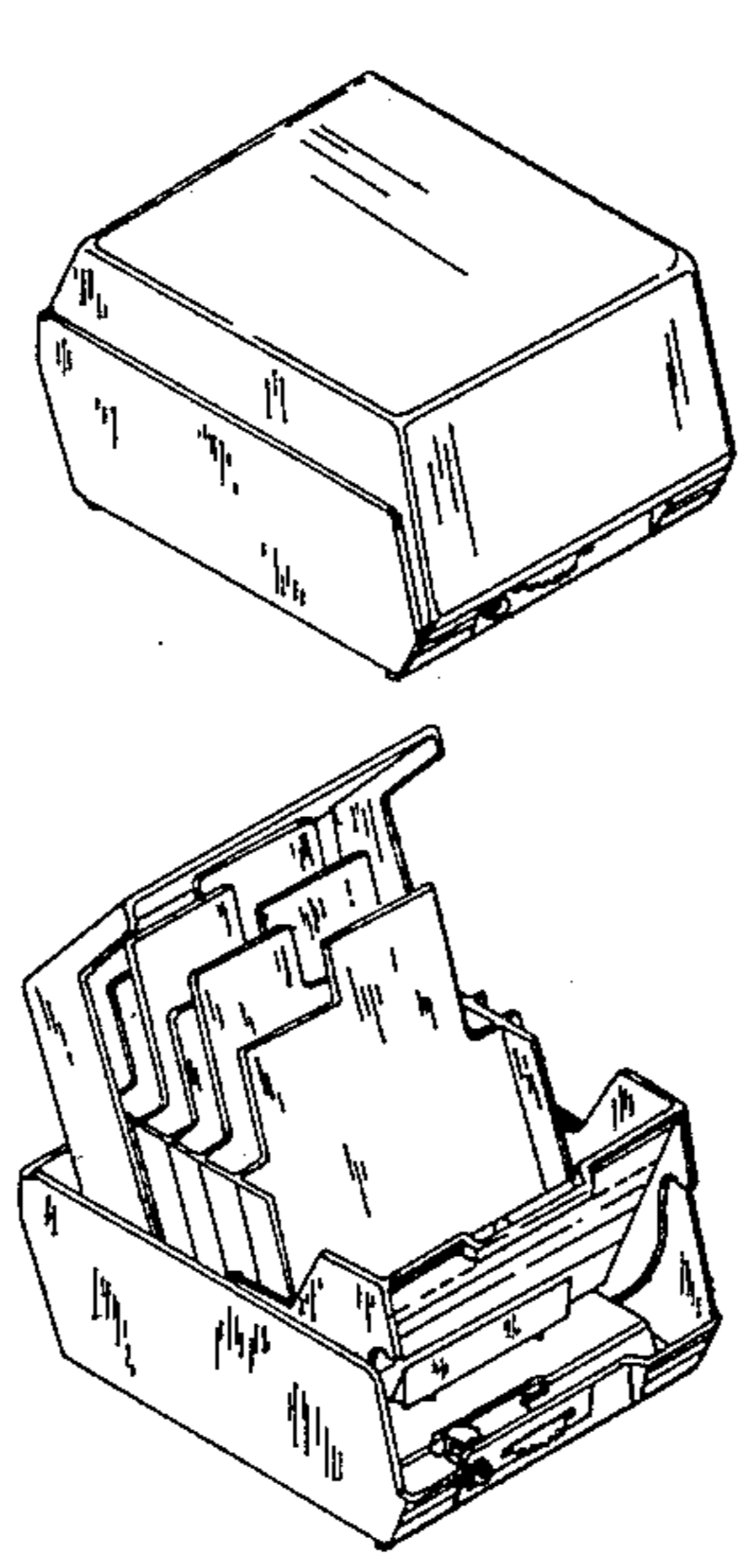

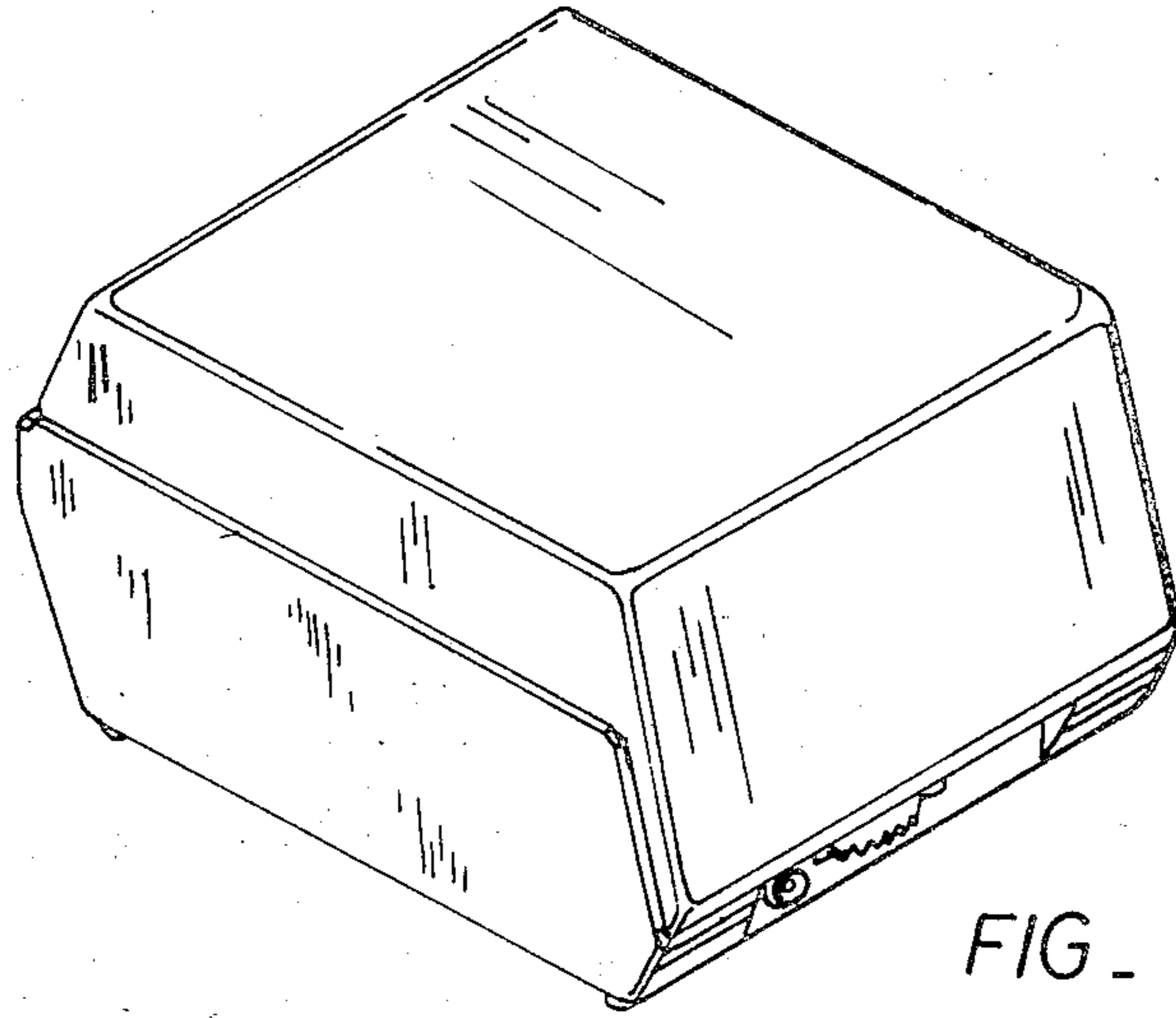

FIG. 1

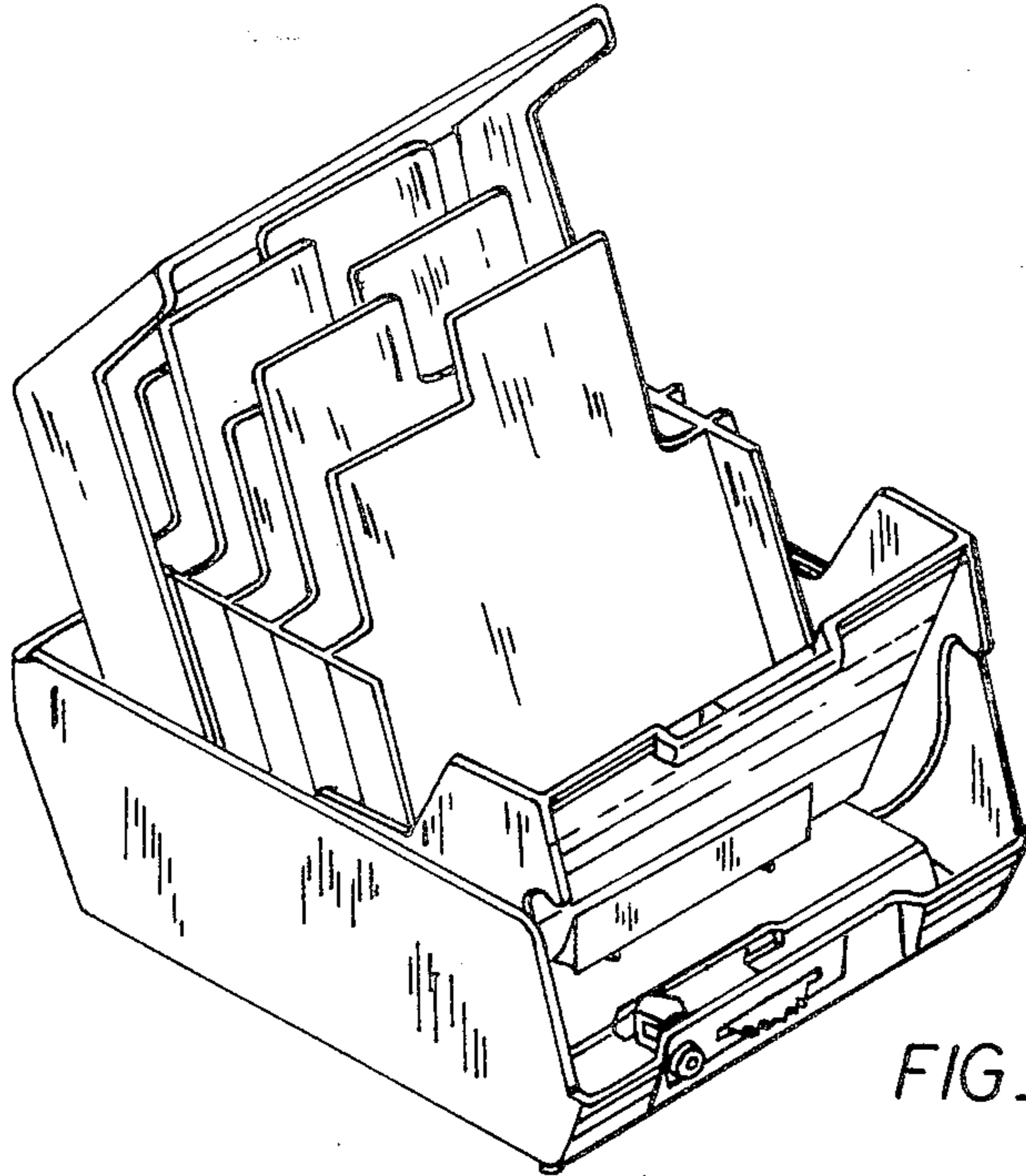

FIG. 2

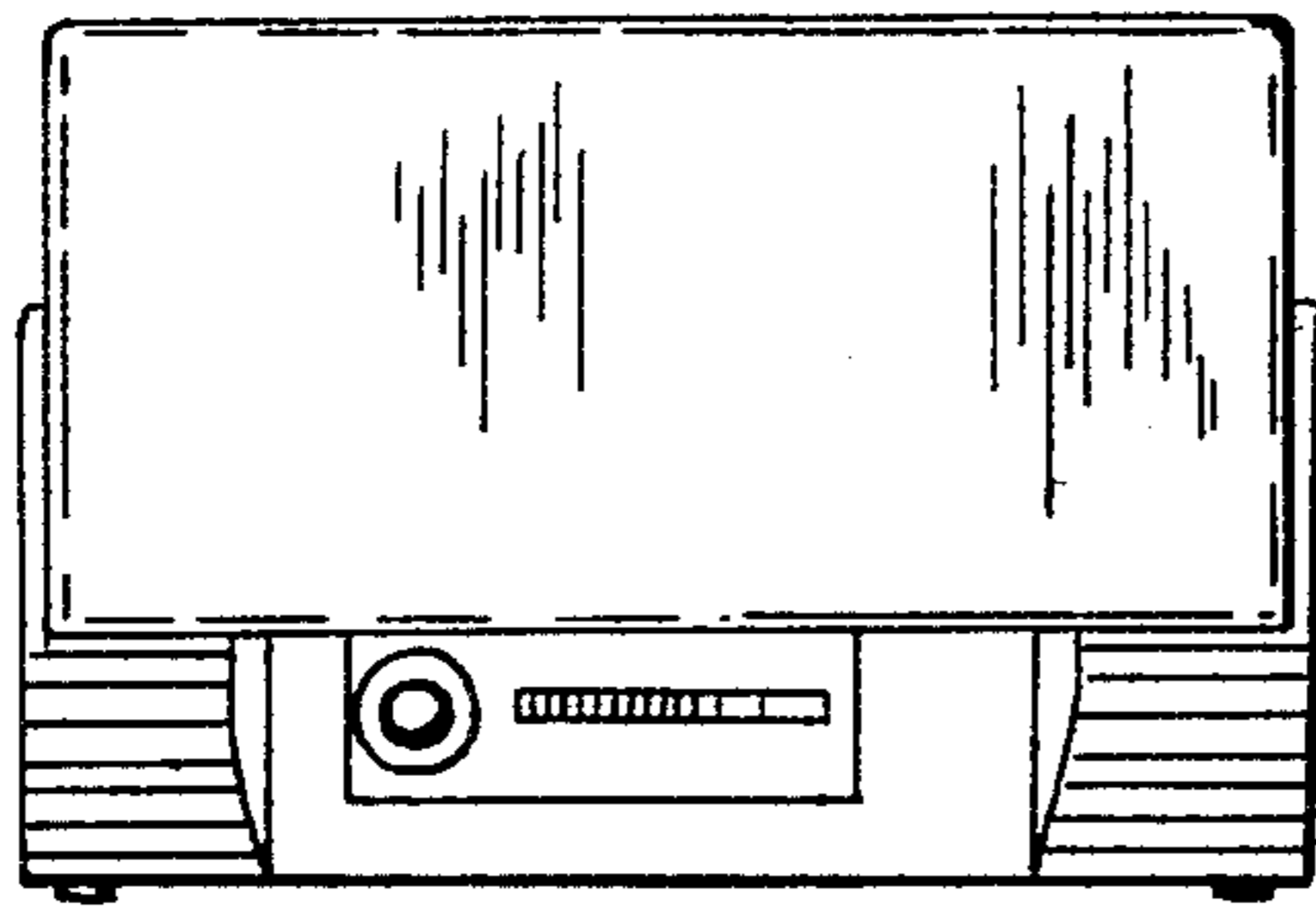

FIG. 3

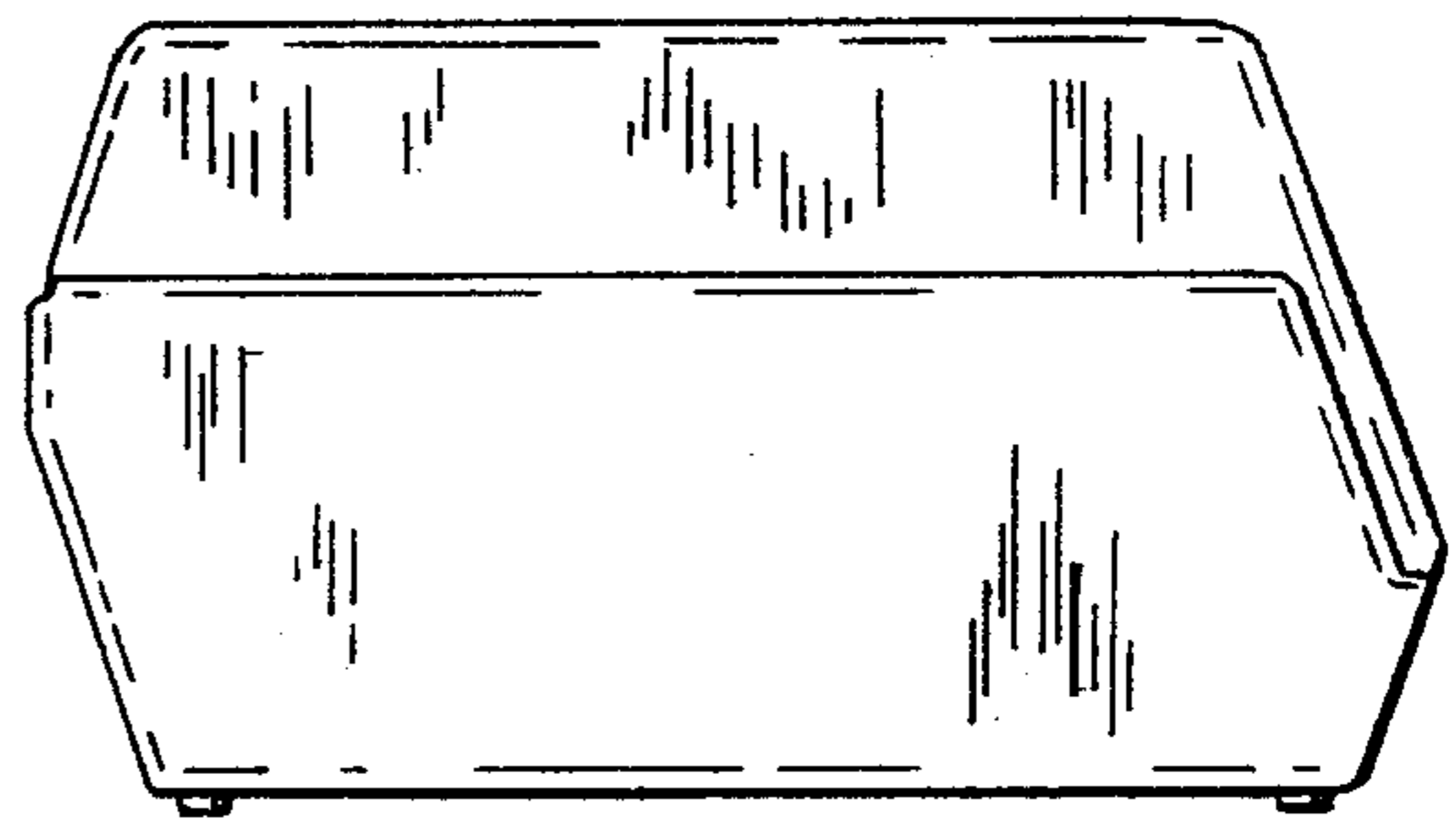

FIG. 4

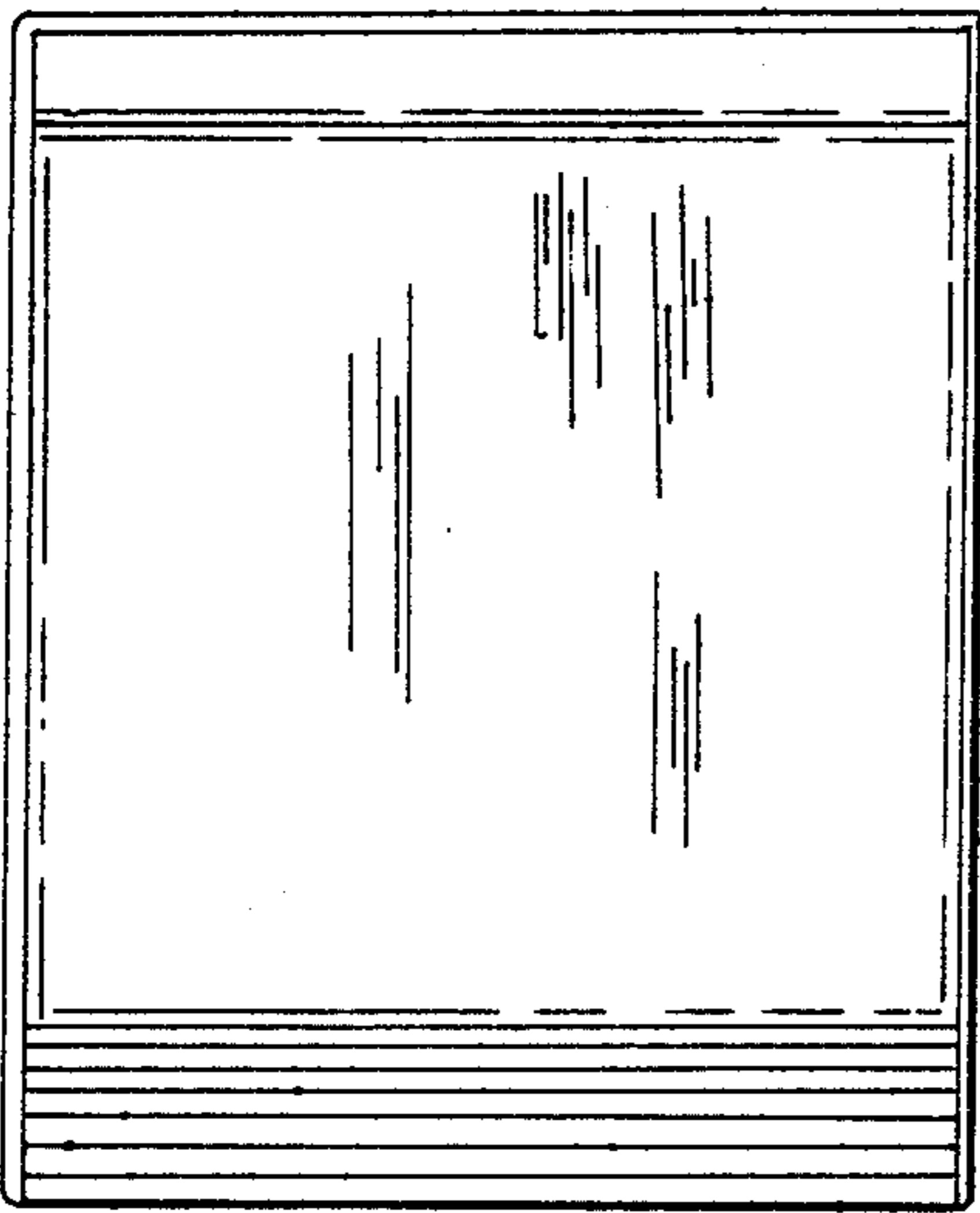

FIG. 5

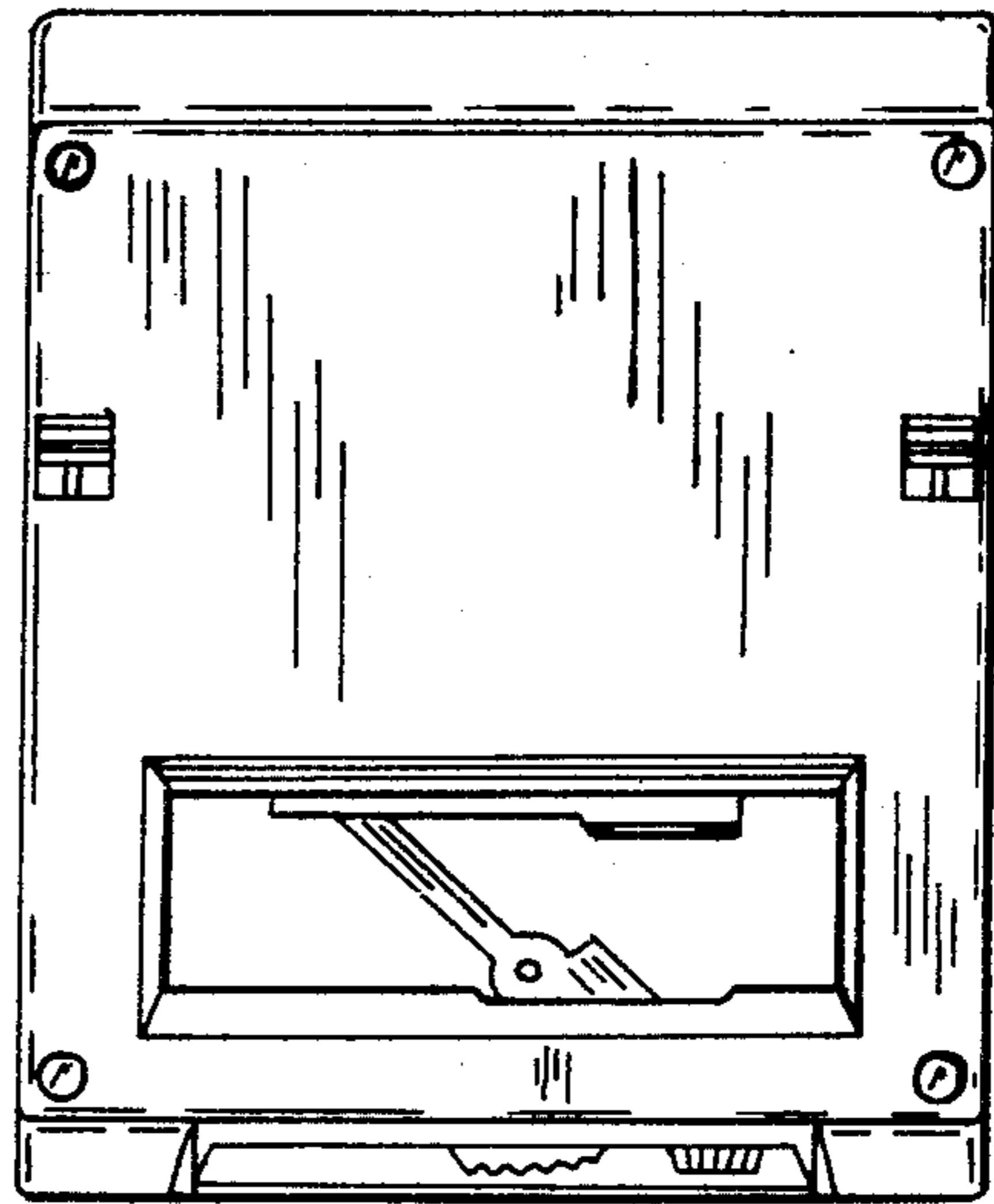

FIG. 6

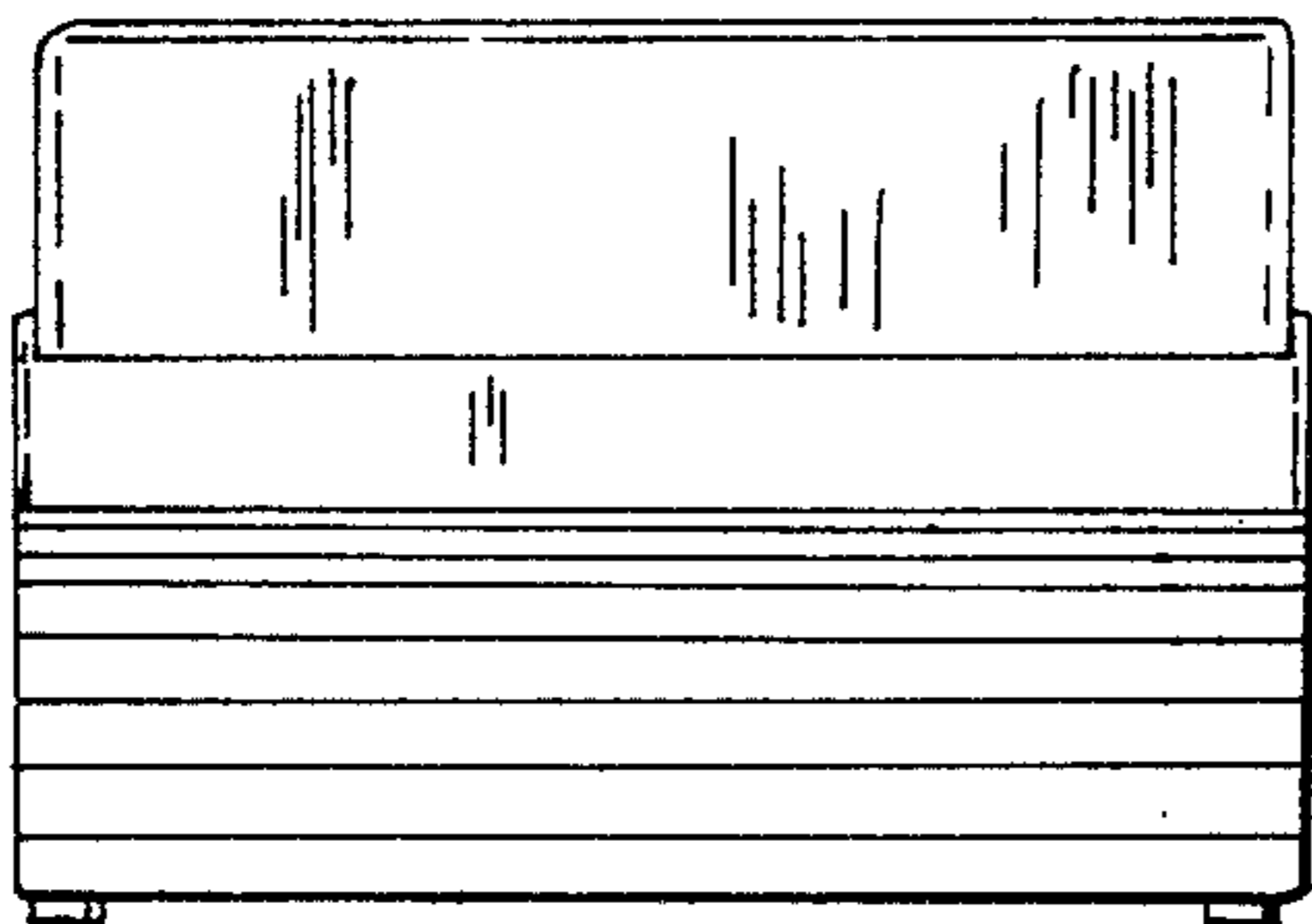

FIG. 7