

[54] PRINTER

[75] Inventors: Douglas E. Goodner, Matthews; David V. Iorio, Harrisburg, both of N.C.

[73] Assignee: International Business Machines Corporation, Armonk, N.Y.

[**] Term: 14 Years

[21] Appl. No.: 659,743

[22] Filed: Oct. 11, 1984

[52] U.S. Cl. D14/111

[58] Field of Search D14/100, 107, 111, 114; D18/13, 22, 23; 400/690.1, 691, 693, 613.2, 616.2, 624

[56] References Cited

U.S. PATENT DOCUMENTS

- D. 249,347 9/1978 Zierhut D14/111
- D. 266,849 11/1982 Meister, Jr. et al. D14/111

- D. 269,782 7/1983 Canning et al. D14/111
- D. 281,247 11/1985 Lahey et al. D14/111

OTHER PUBLICATIONS

Smith Corona ® TP-11 AD; Electronic Text Printer.

Primary Examiner—Susan J. Lucas
Attorney, Agent, or Firm—E. Ronald Coffman

[57] CLAIM

The ornamental design for a printer, substantially as shown and described.

DESCRIPTION

FIG. 1 is a front left perspective view of a printer showing our new design;
 FIG. 2 is a right rear perspective view thereof;
 FIG. 3 is a top plan view thereof;
 FIG. 4 is a front elevational view thereof;
 FIG. 5 is a left side elevational view thereof;
 FIG. 6 is a right side elevational view thereof;
 FIG. 7 is a rear elevational view thereof.
 The bottom of the printer is unornamented.

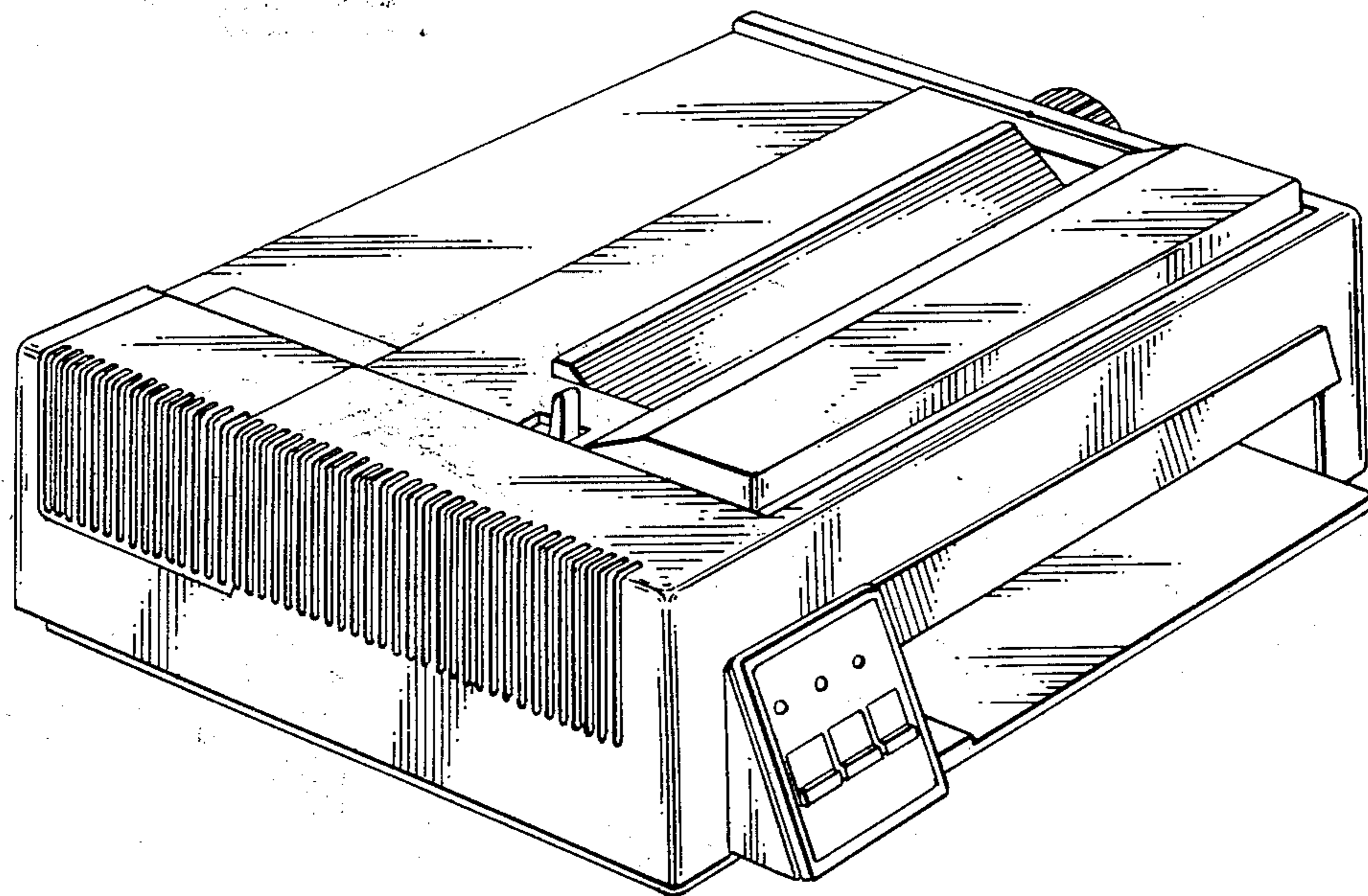

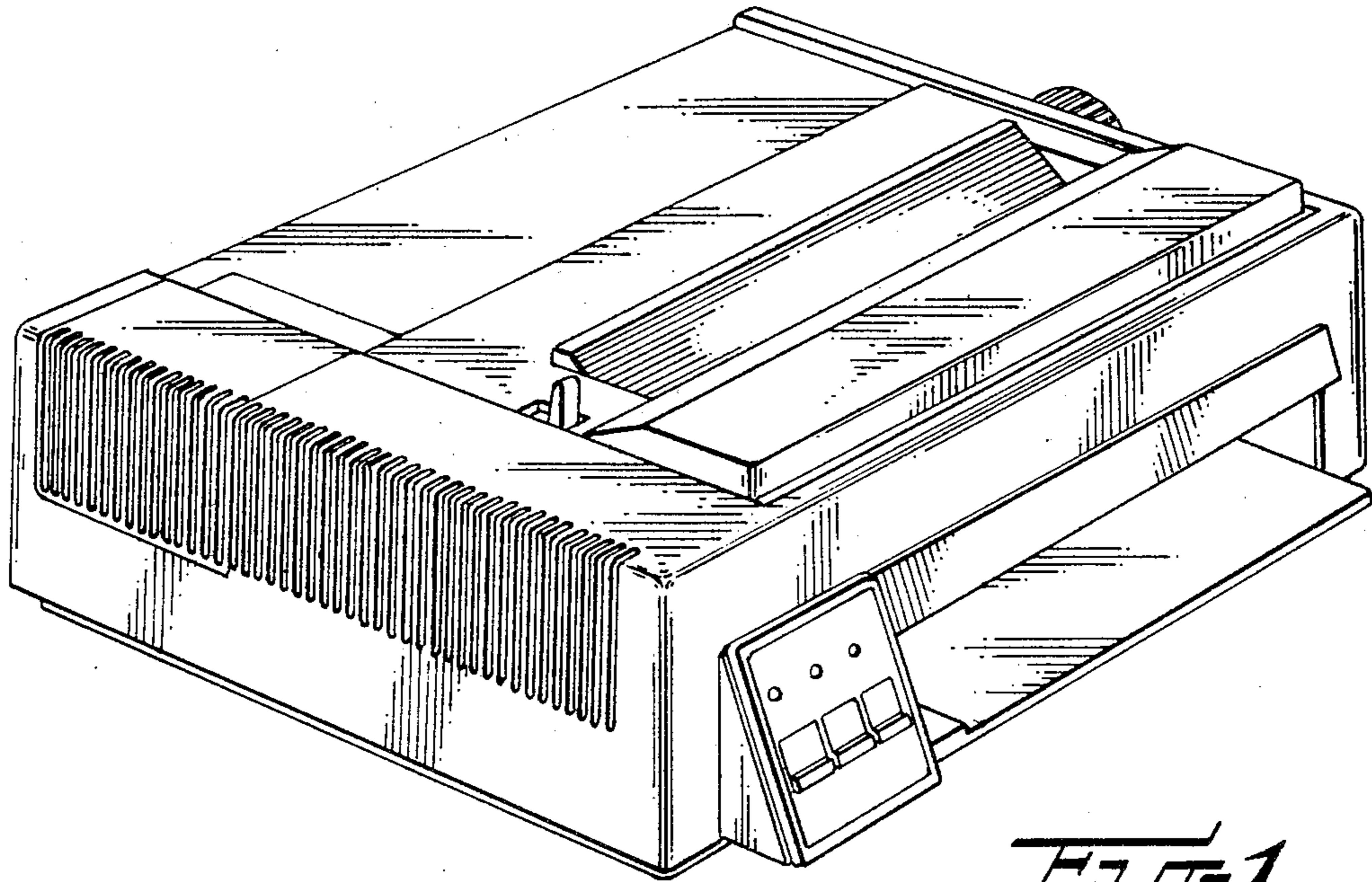

FIG-1

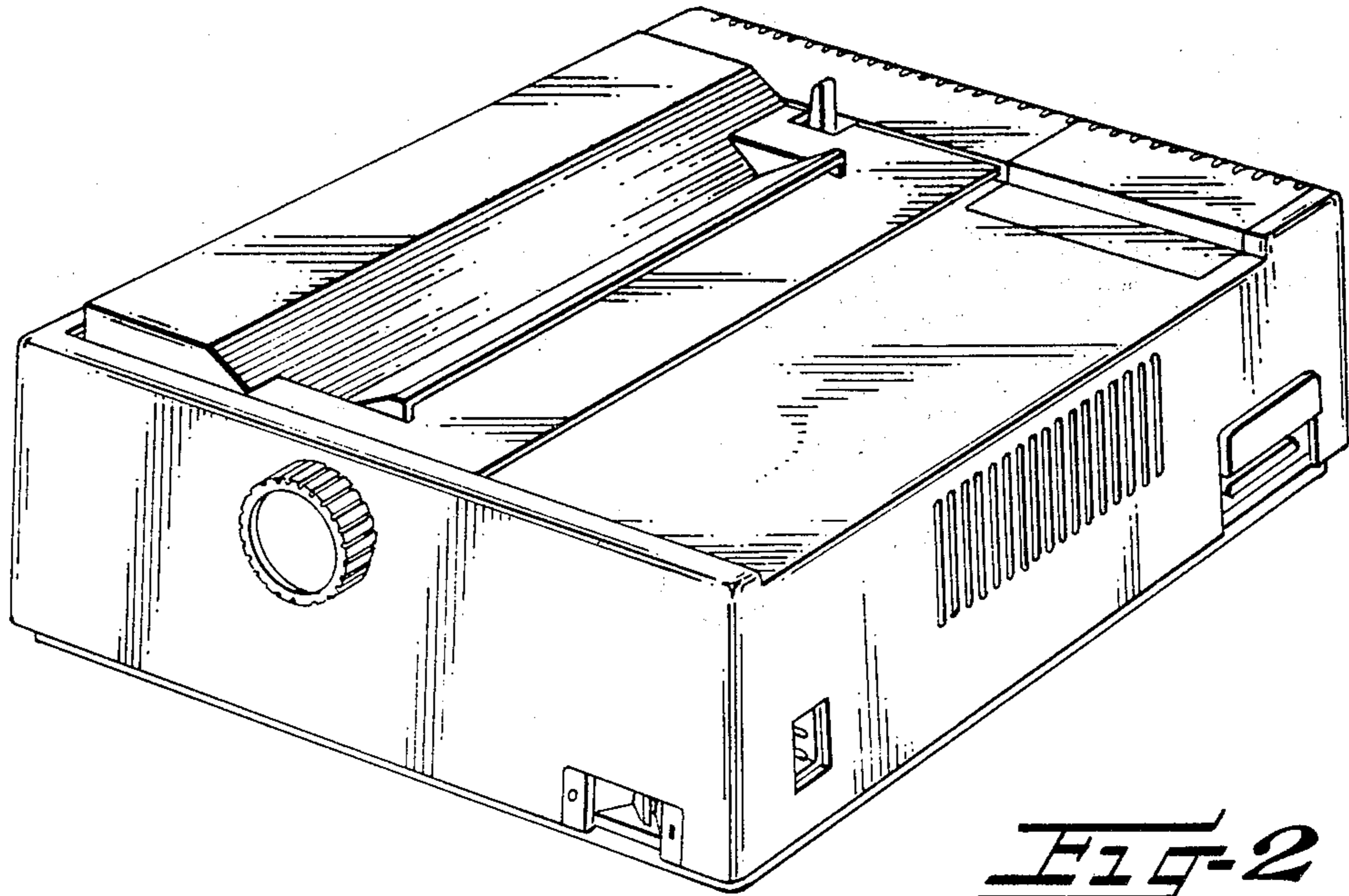

FIG-2

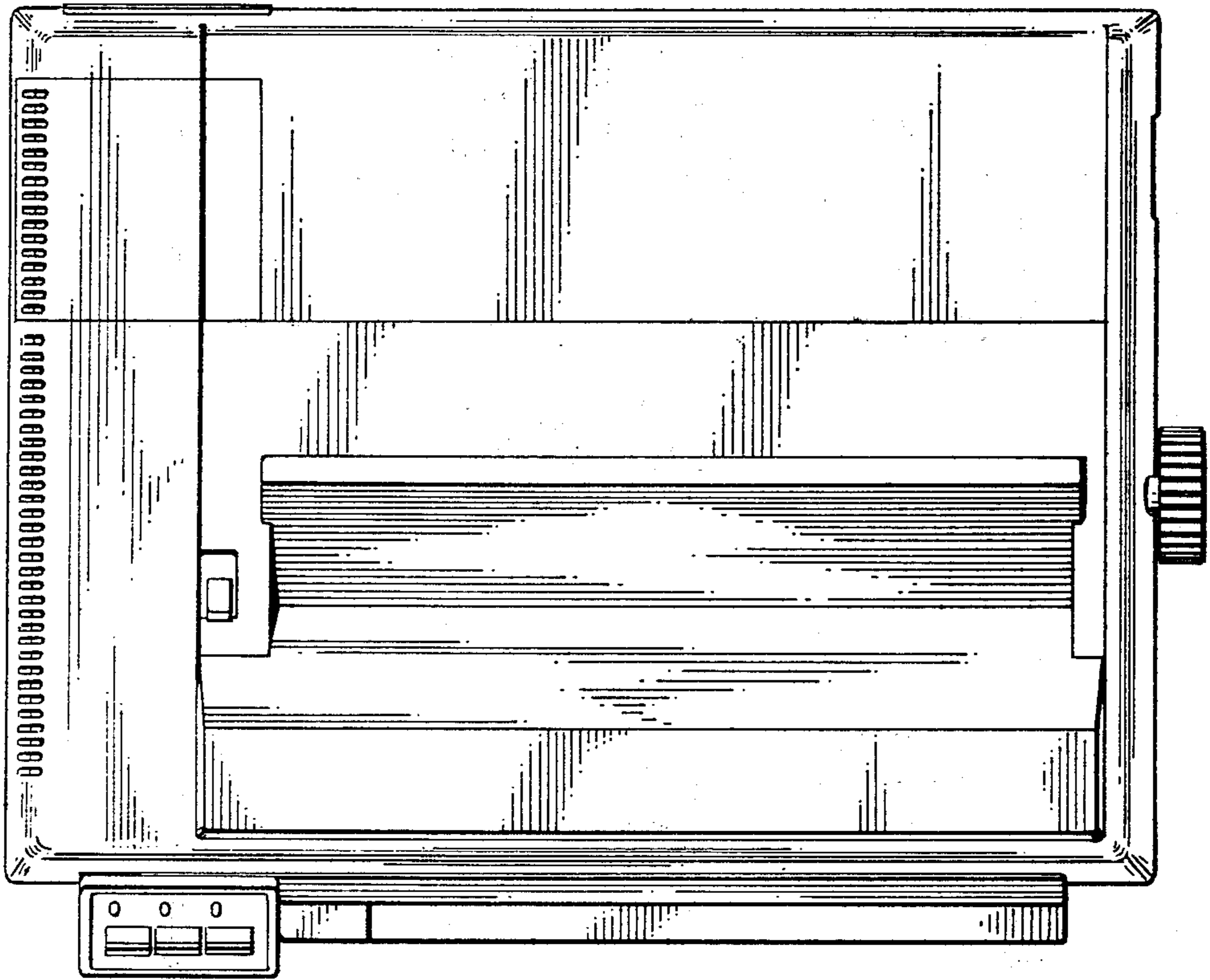

FIG-3

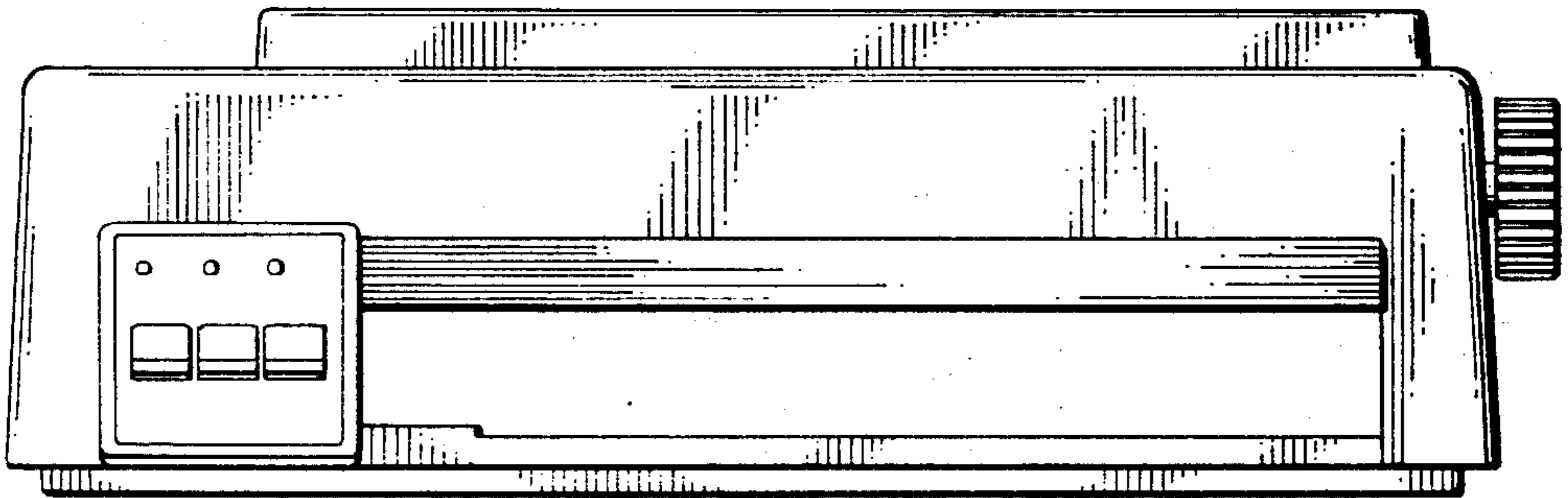

FIG-4

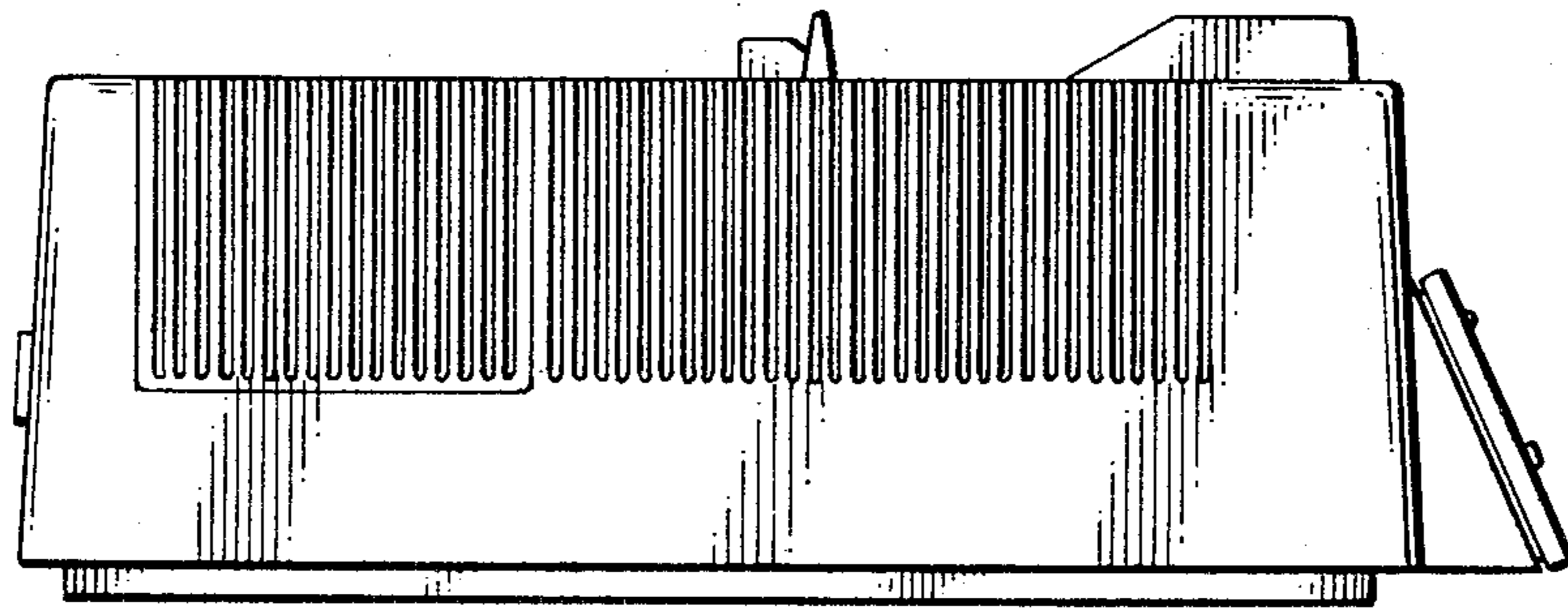

FIG-5

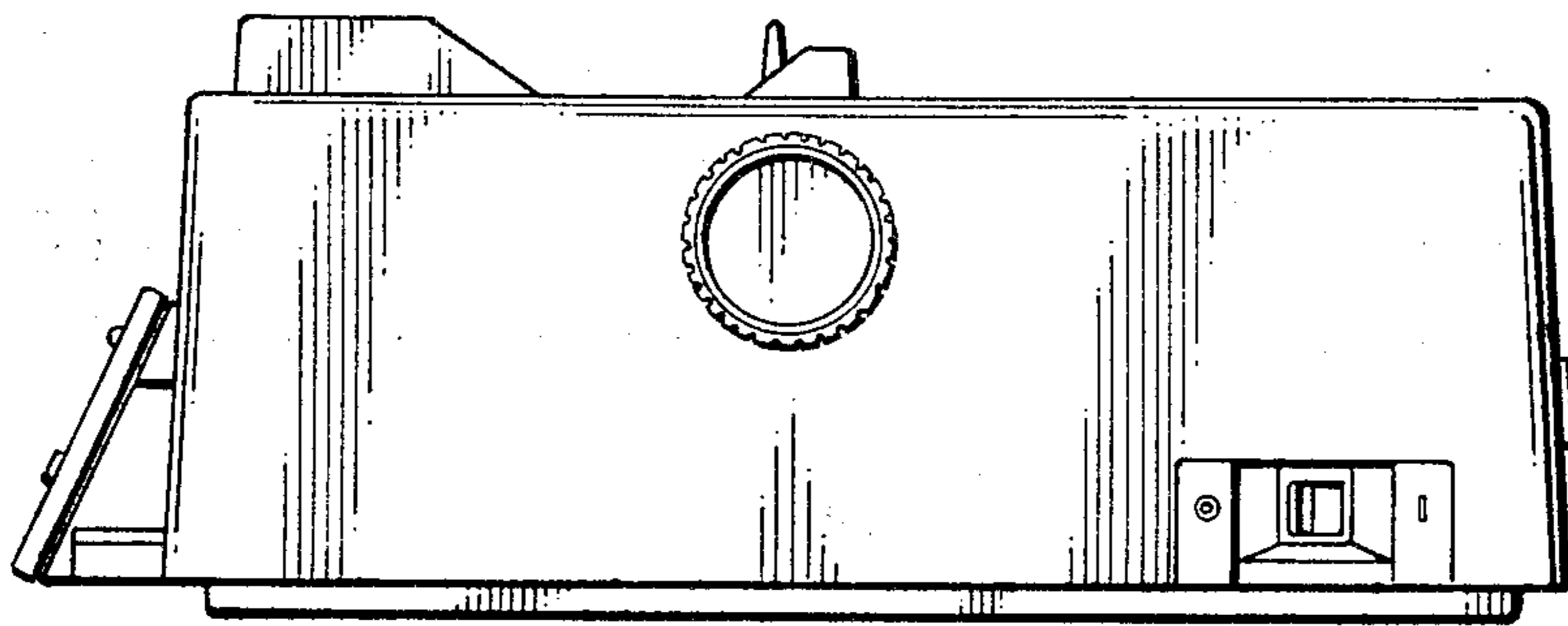

FIG-6

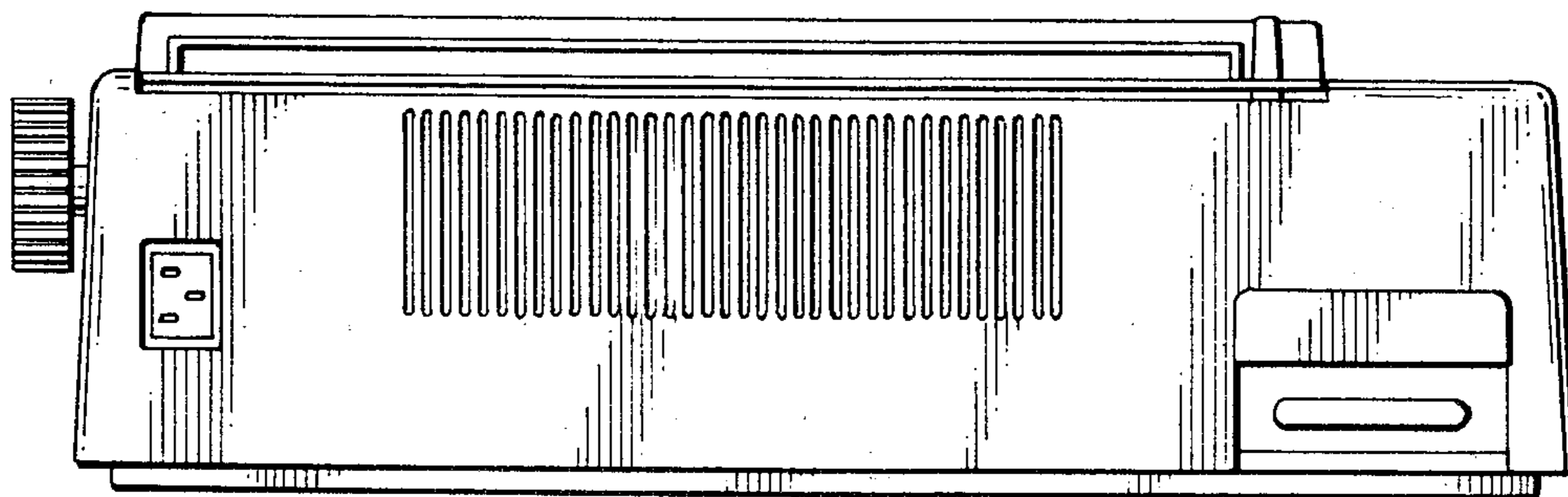

FIG-7