

[54] BOAT

[76] Inventor: Frank R. Goodman, 72 Whittingham Road, Mapperley, Nottingham, England

[\*\*] Term: 14 Years

[21] Appl. No.: 664,558

[22] Filed: Oct. 25, 1984

[30] Foreign Application Priority Data

May 18, 1984 [GB] United Kingdom ..... 1019751  
[52] U.S. Cl. .... D12/303  
[58] Field of Search ..... D12/300, 302, 303, 304, D12/306; 114/39, 56, 357, 39 R, 283

[56] References Cited

FOREIGN PATENT DOCUMENTS

2128153 4/1984 United Kingdom ..... 114/39

OTHER PUBLICATIONS

Marine Concepts Brochure, p. 2, Sea Pearl 21, (upper left).

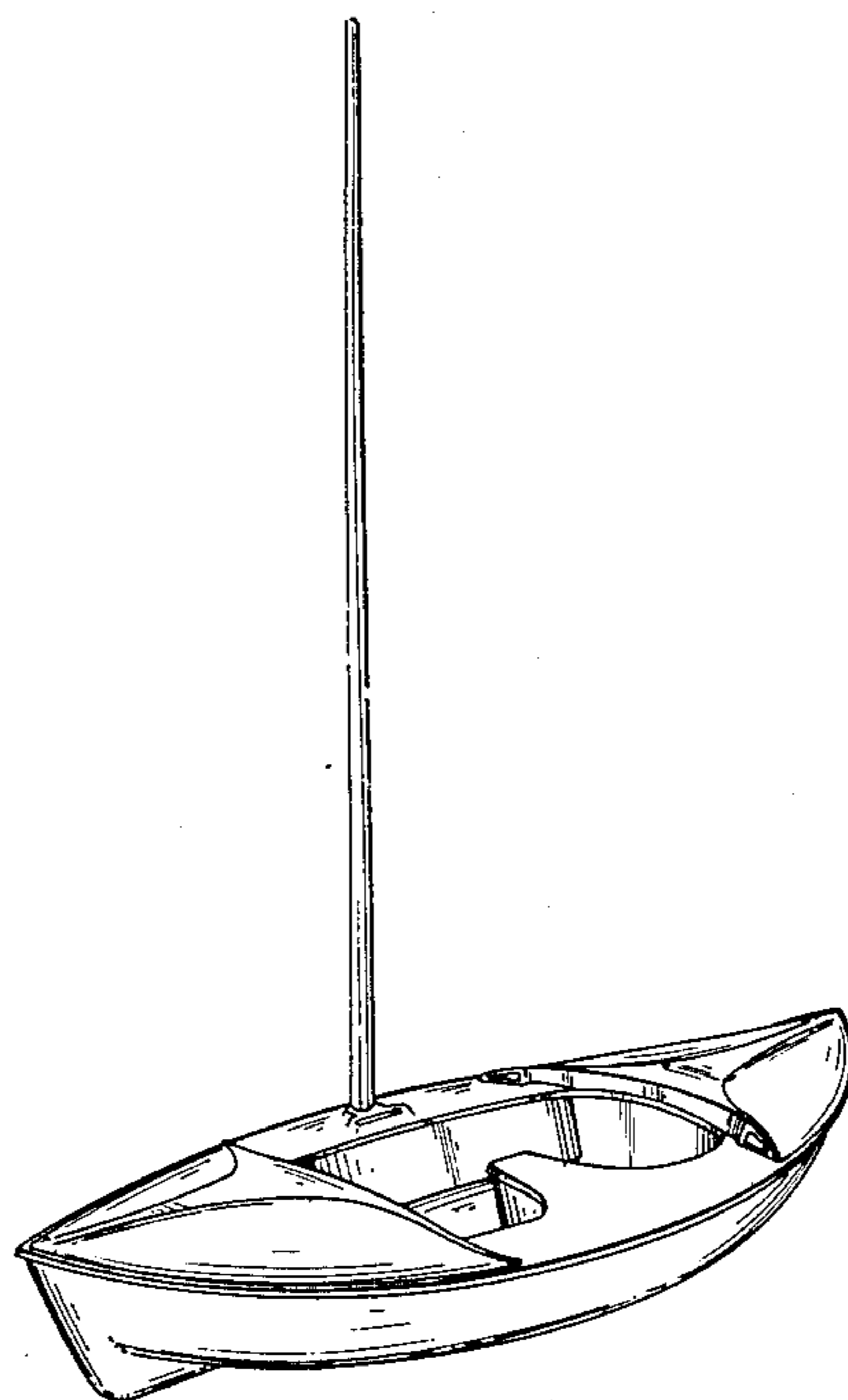
Primary Examiner—James M. Gandy  
Assistant Examiner—Kay H. Chin  
Attorney, Agent, or Firm—Bachman & LaPointe

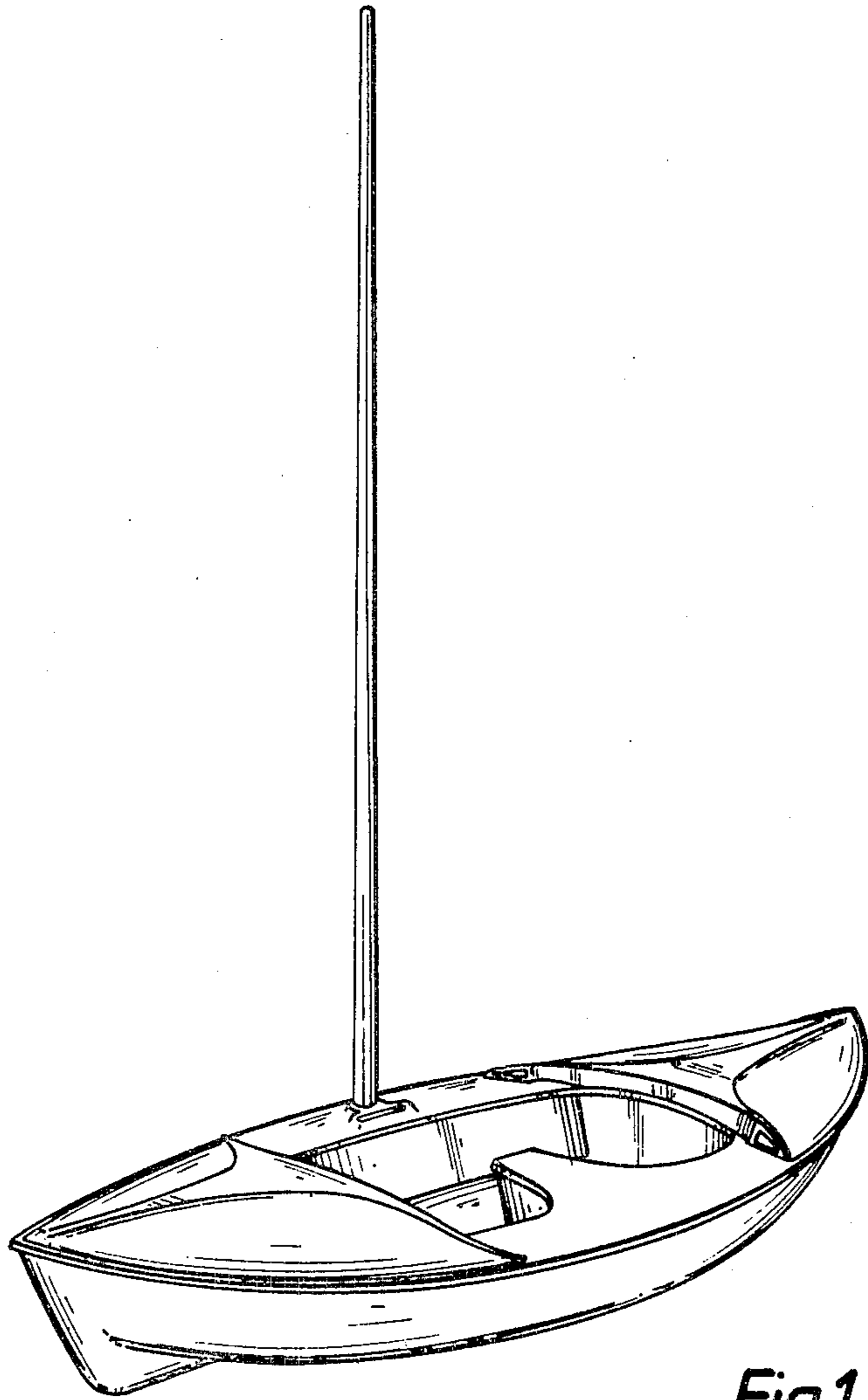
[57] CLAIM

The ornamental design for a boat, as shown and described.

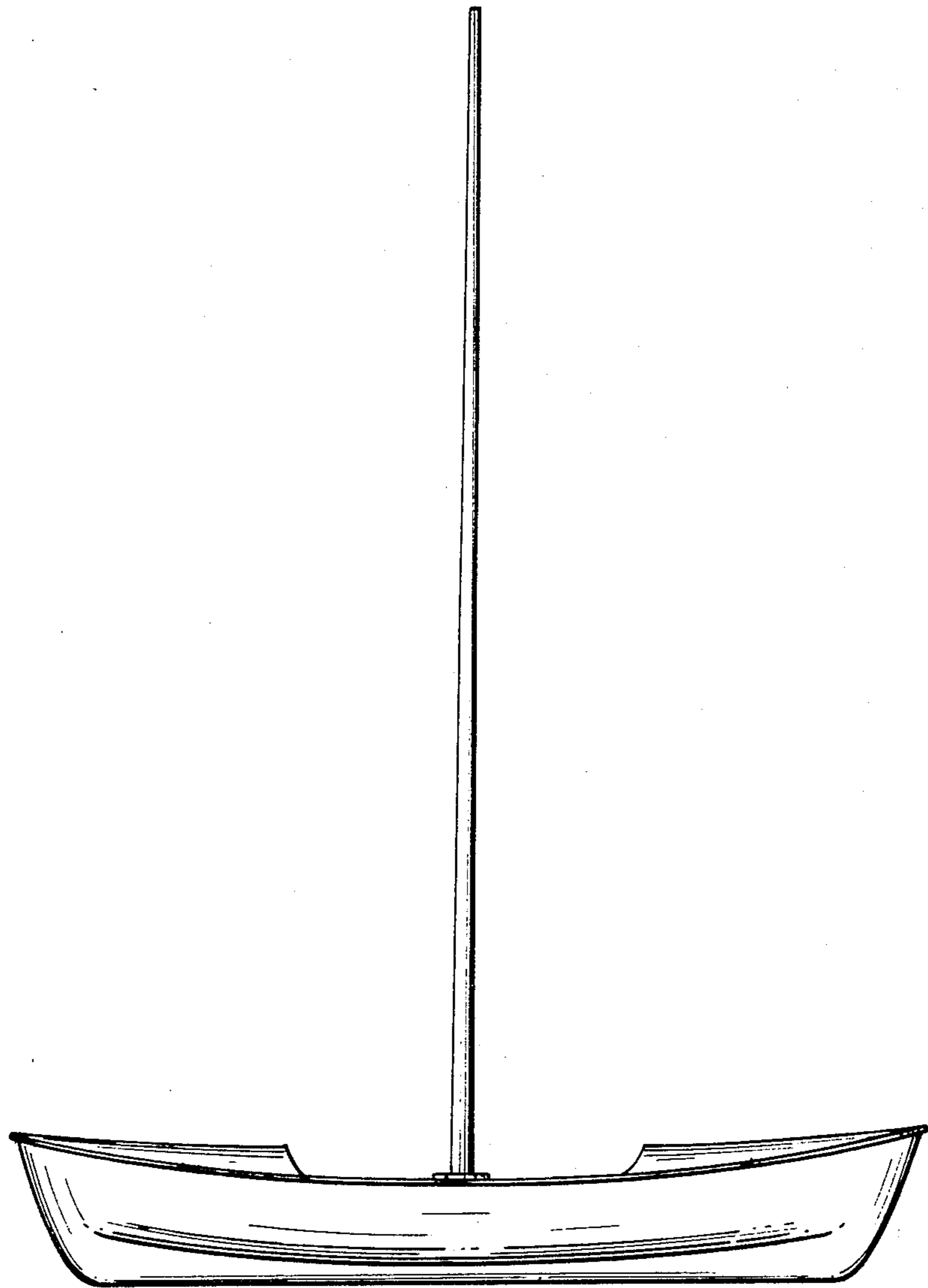
DESCRIPTION

FIG. 1 is a perspective view of a boat showing my new design;  
FIG. 2 is a side elevational view thereof, the opposite side being a mirror image of that shown;  
FIG. 3 is a bottom plan view thereof;  
FIG. 4 is a top plan view thereof;  
FIG. 5 is a front elevational view thereof;  
FIG. 6 is a sectional view thereof, taken along the line 6—6 of FIG. 4; and  
FIG. 7 is a sectional view thereof, taken along the line 7—7 of FIG. 4.

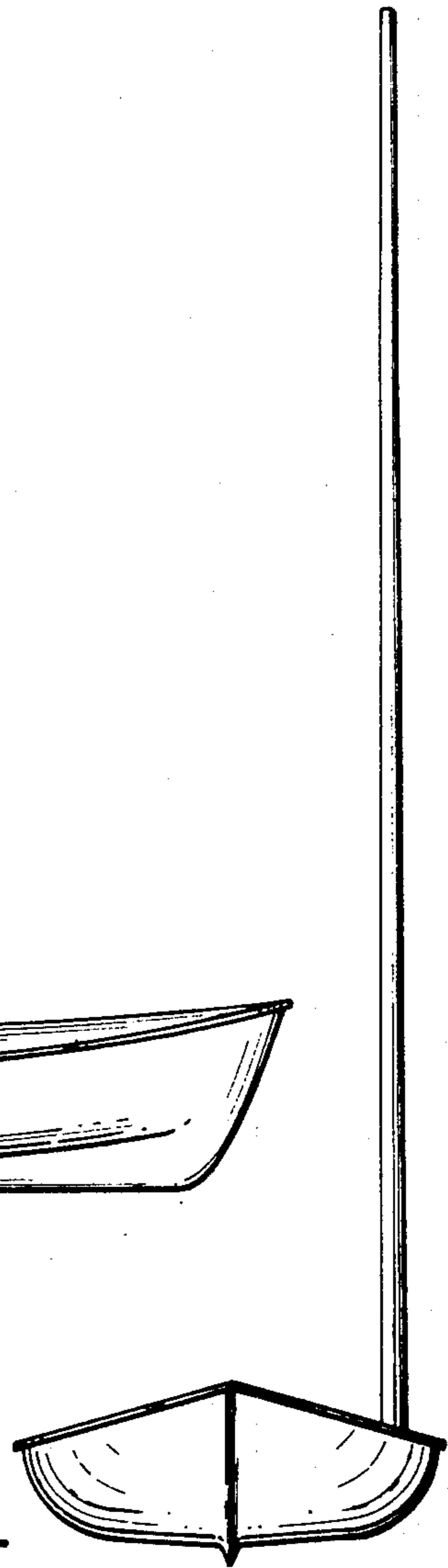




*Fig.1.*



*Fig. 2.*



*Fig. 5.*

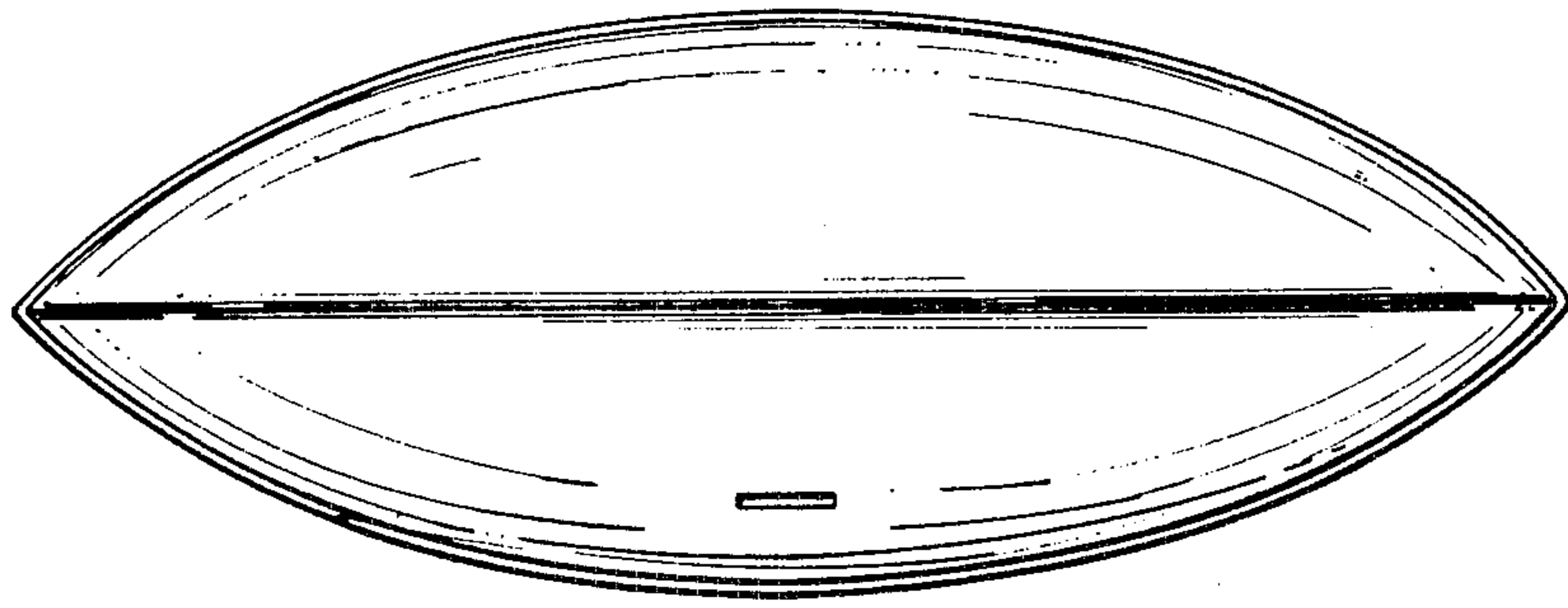


Fig. 3.

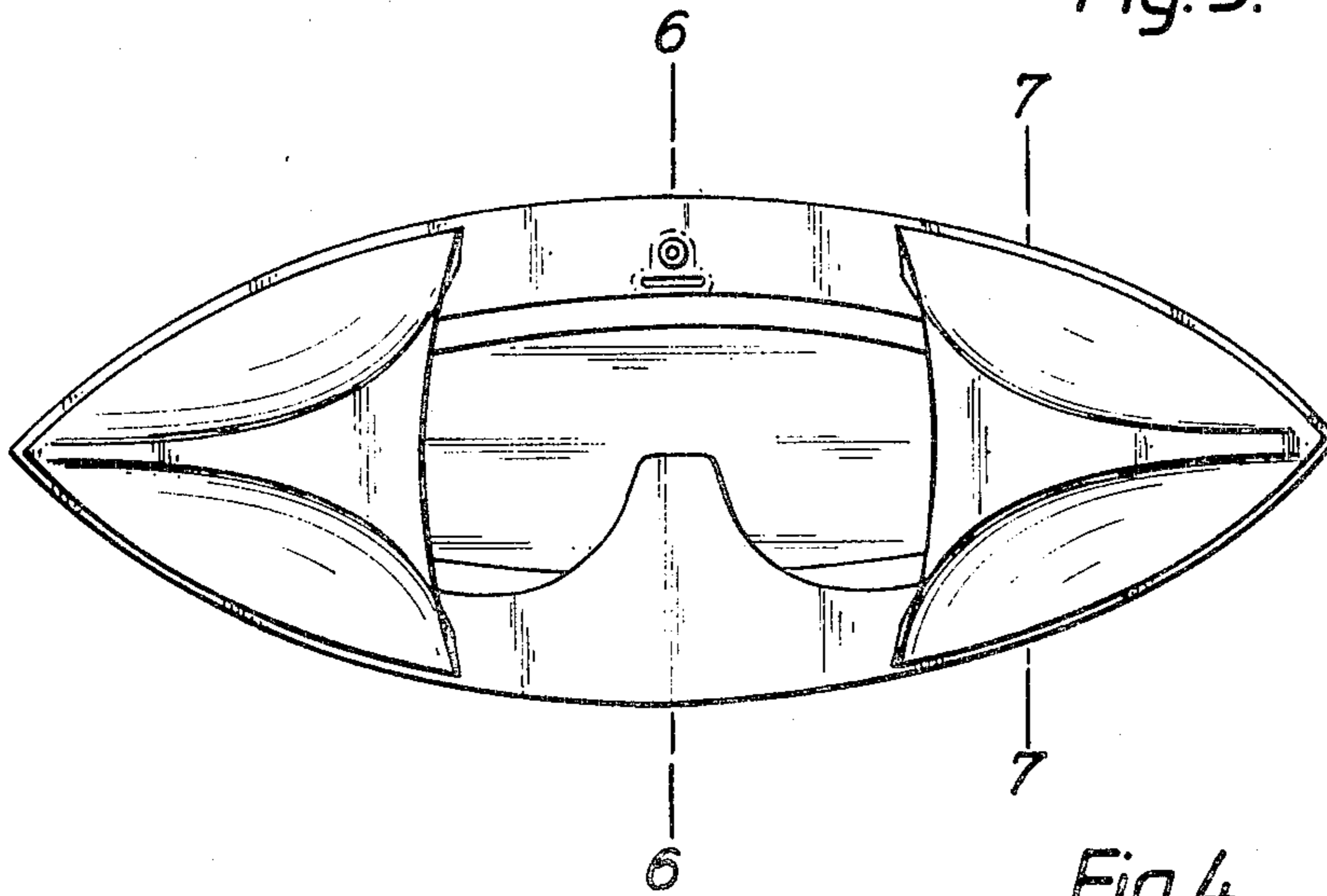


Fig. 4.

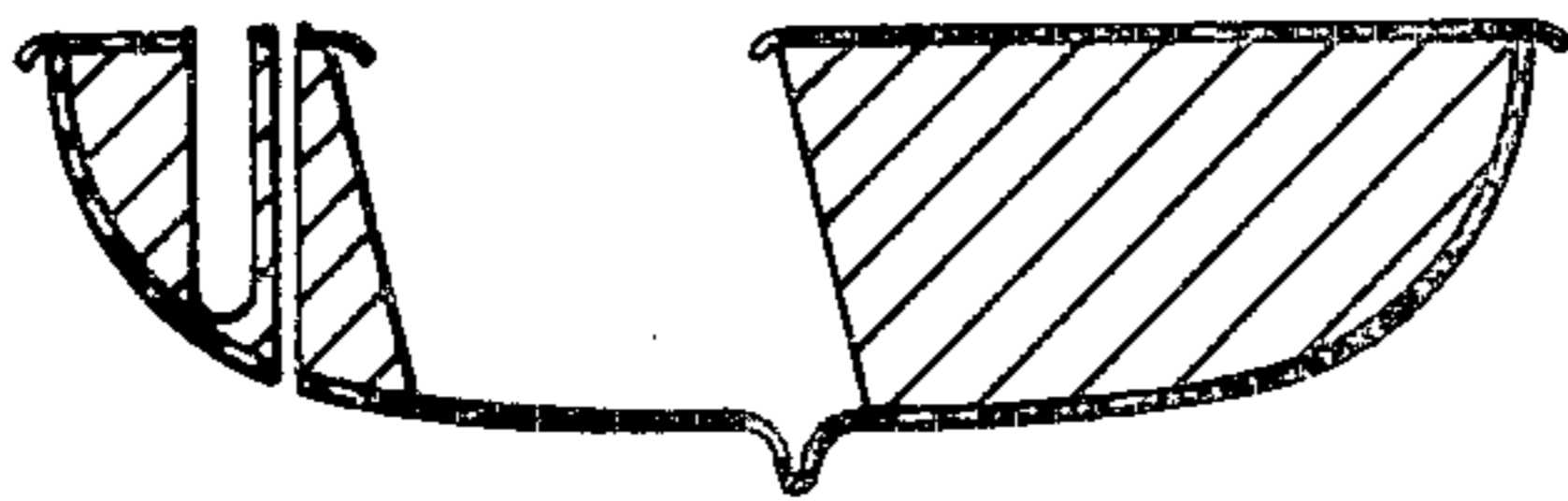


Fig. 6.

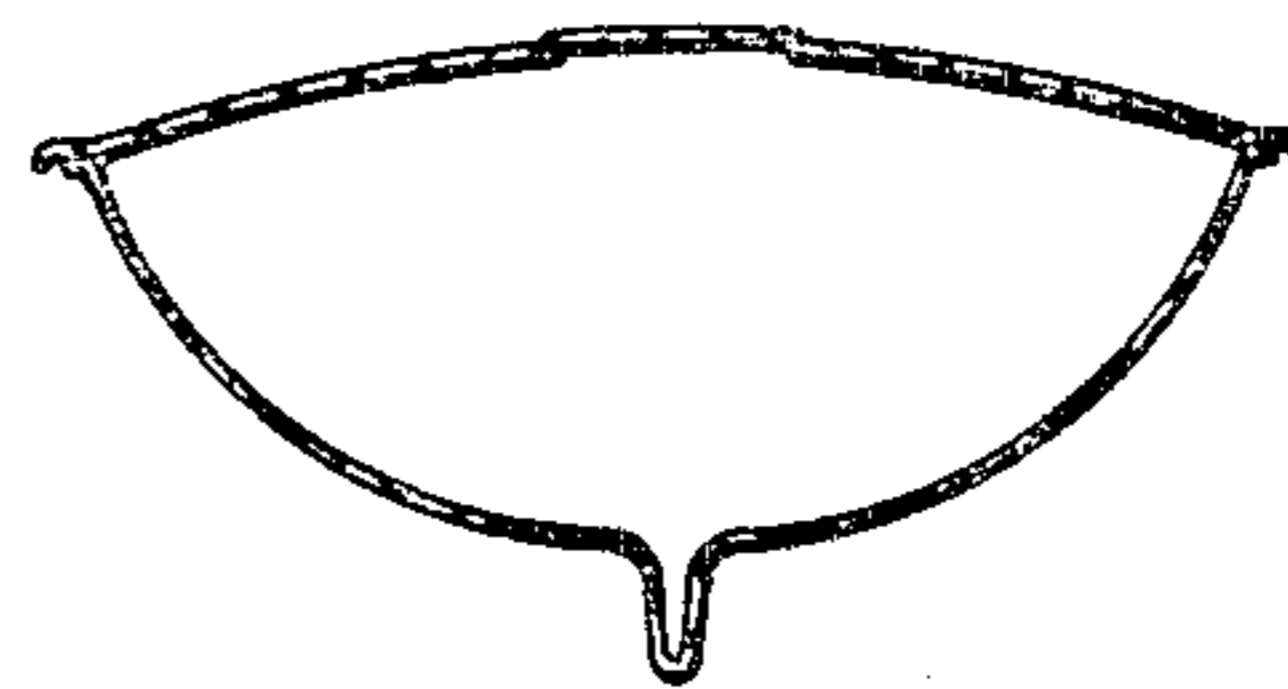


Fig. 7.