

[54] APPARATUS FOR AESTHETIC TREATMENTS OF FACE AND BODY

[75] Inventor: Koichi Takigawa, Tokyo, Japan

[73] Assignee: Takigawa Kabushiki-Kaisha, Tokyo, Japan

[\*\*] Term: 14 Years

[21] Appl. No.: 626,627

[22] Filed: Jul. 2, 1984

[52] U.S. Cl. .... D28/9; D24/40

[58] Field of Search ..... D28/9-11, D28/99; D24/36, 40; 132/1 R, 9; 219/222

[56] References Cited

U.S. PATENT DOCUMENTS

D. 100,493	7/1936	Gaire .....	D28/11
D. 103,574	3/1937	Jacobsen .....	D28/11
2,384,670	9/1945	Fisher et al. ....	D24/40 X
3,043,310	7/1962	Milinowski .....	D24/40 X

OTHER PUBLICATIONS

Modern Salon, 9/1983, p. 7-Esty 2000 Console at center left.

Modern Salon, 9/1983, p. 50-Pibbs Maxi-Vapor #2200 & Complete Skin Care System #2500.

Primary Examiner—Louis S. Zarfes  
Attorney, Agent, or Firm—Ladas & Parry

[57] CLAIM

The ornamental design for an apparatus for aesthetic treatments of face and body, as shown.

DESCRIPTION

FIG. 1 is a top isometric view of an apparatus for aesthetic treatments of face and body embodying our new design;

FIG. 2 is a top plan view thereof;

FIG. 3 is a front elevational view thereof;

FIG. 4 is a rear elevational view thereof;

FIG. 5 is a bottom plan view thereof;

FIG. 6 is a right end elevational view thereof; and

FIG. 7 is a left elevational view thereof.

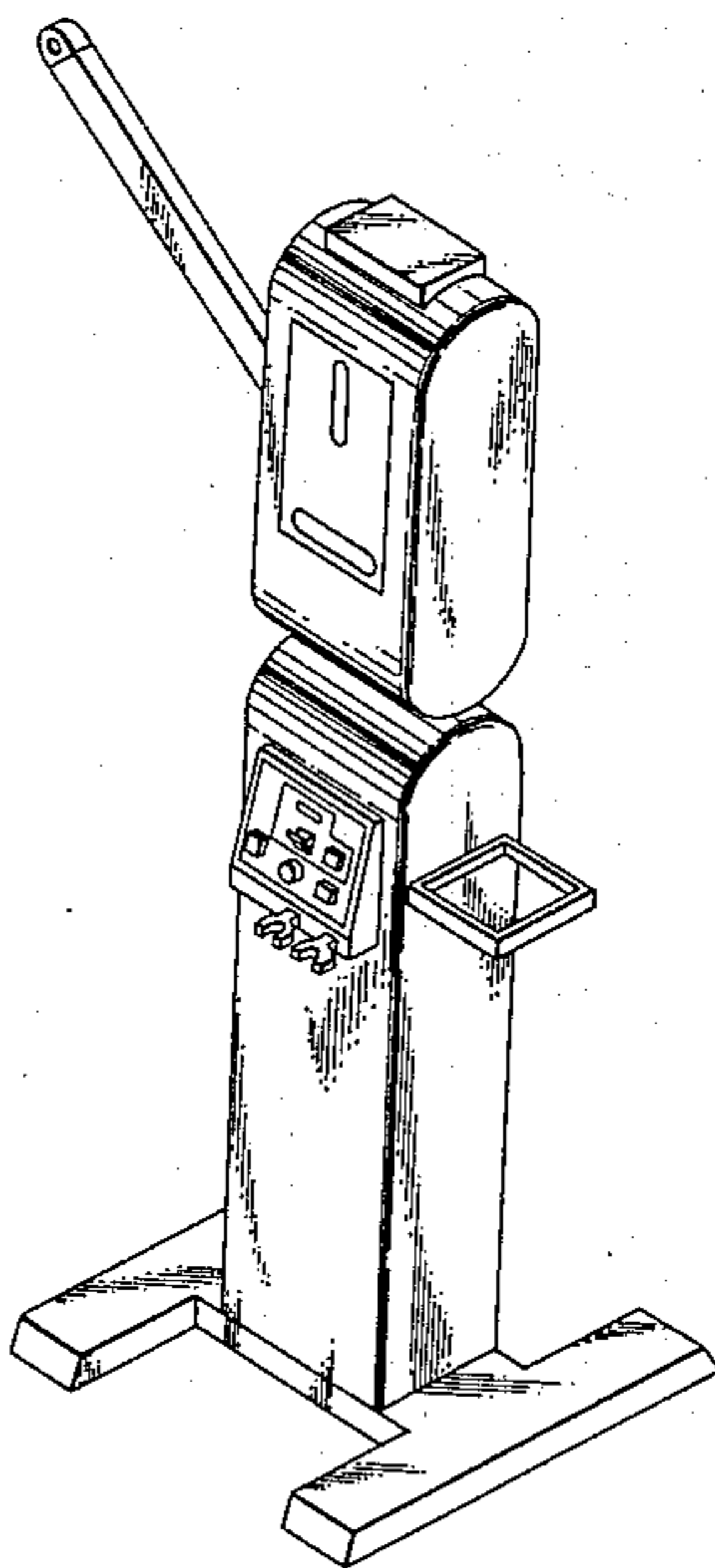
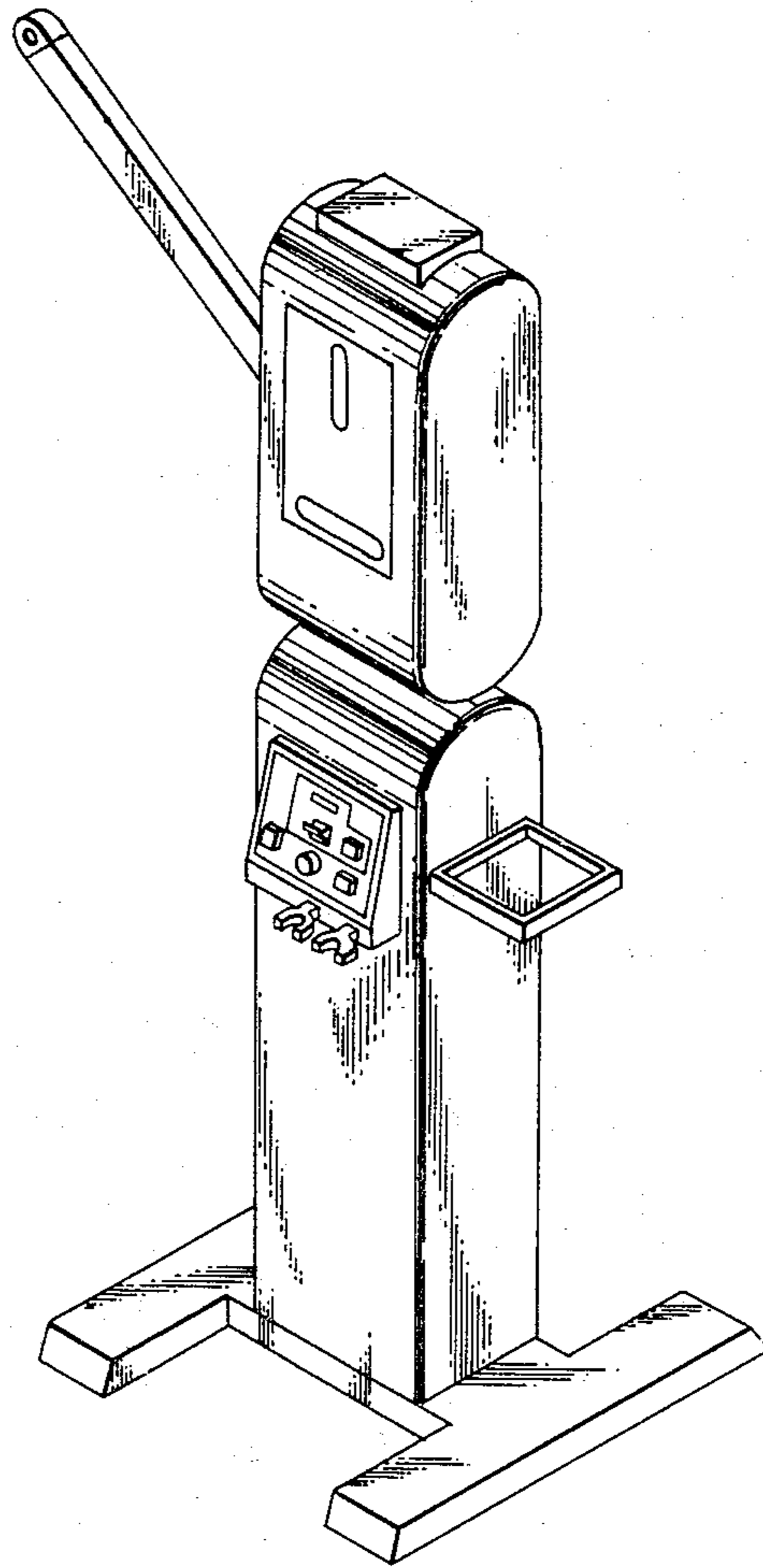

FIG. 1



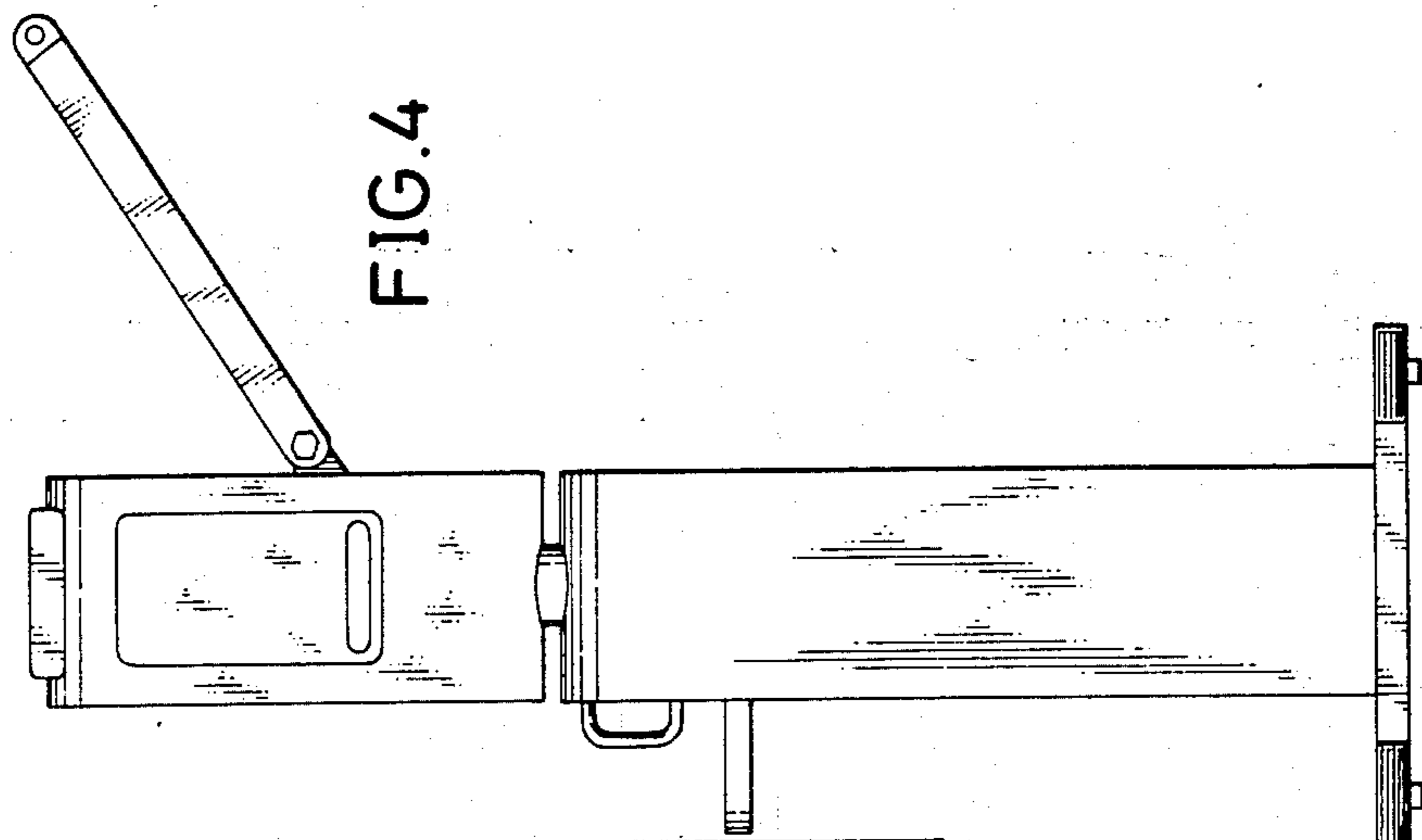

FIG. 4

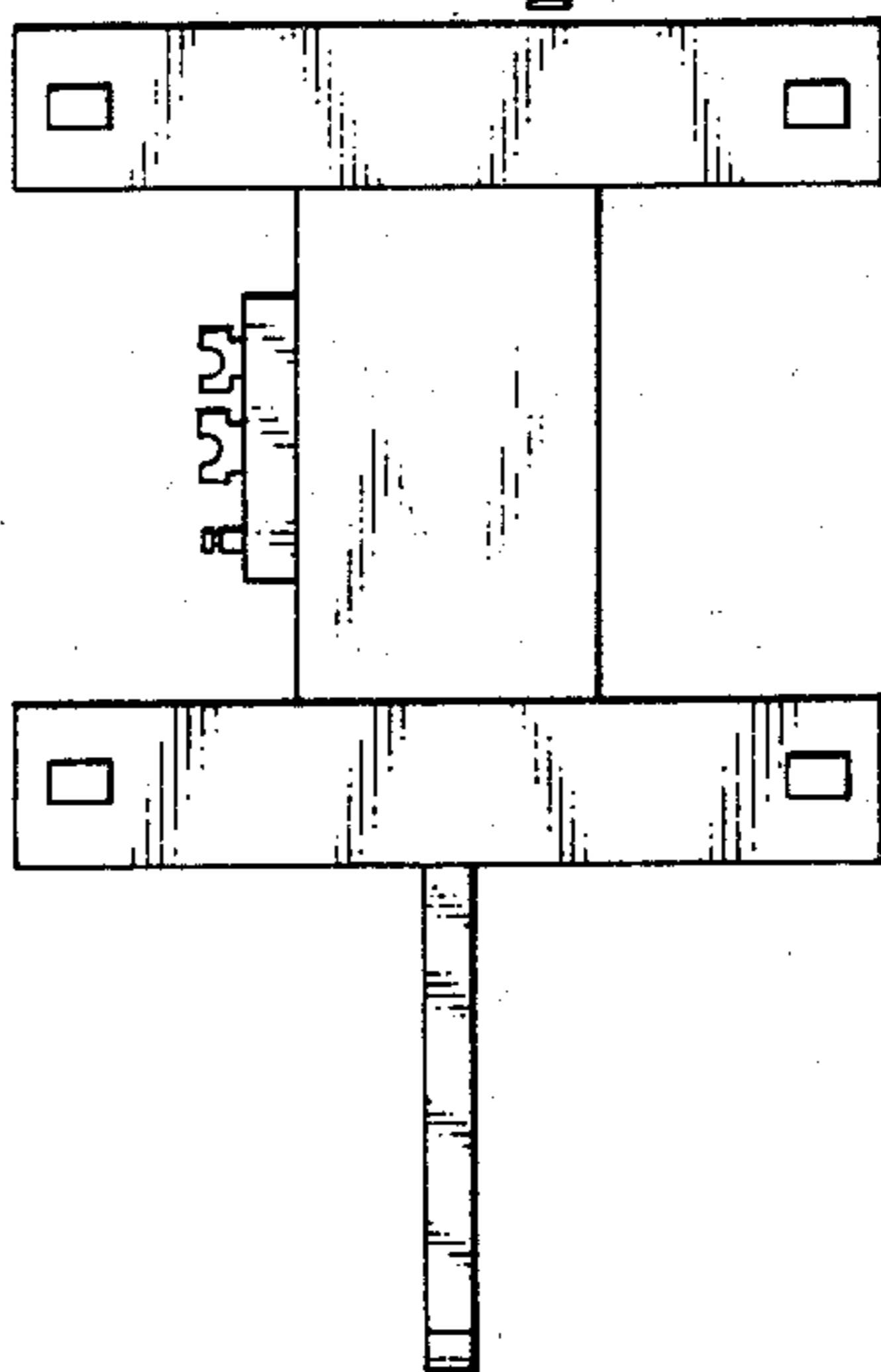

FIG. 5

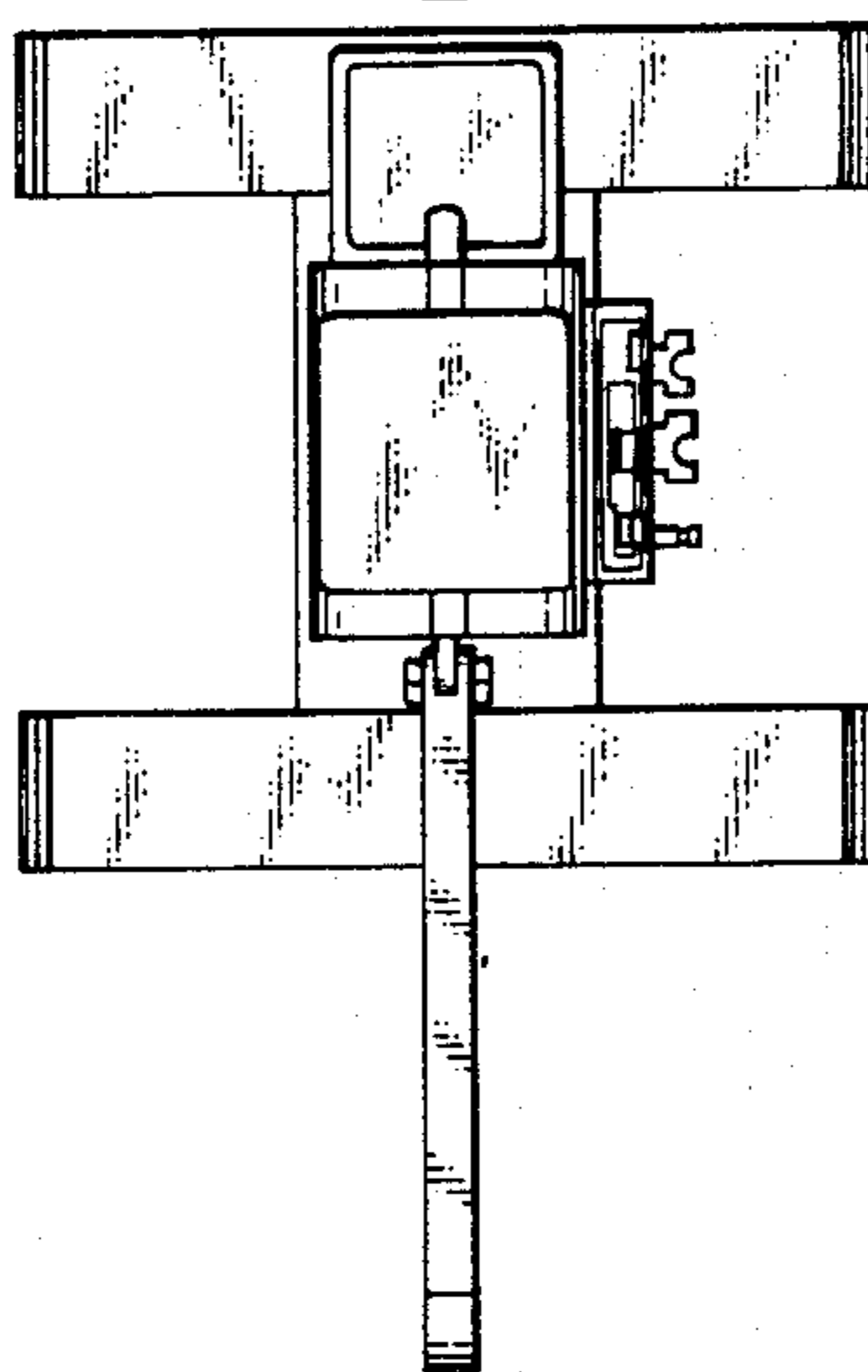

FIG. 2

FIG. 7

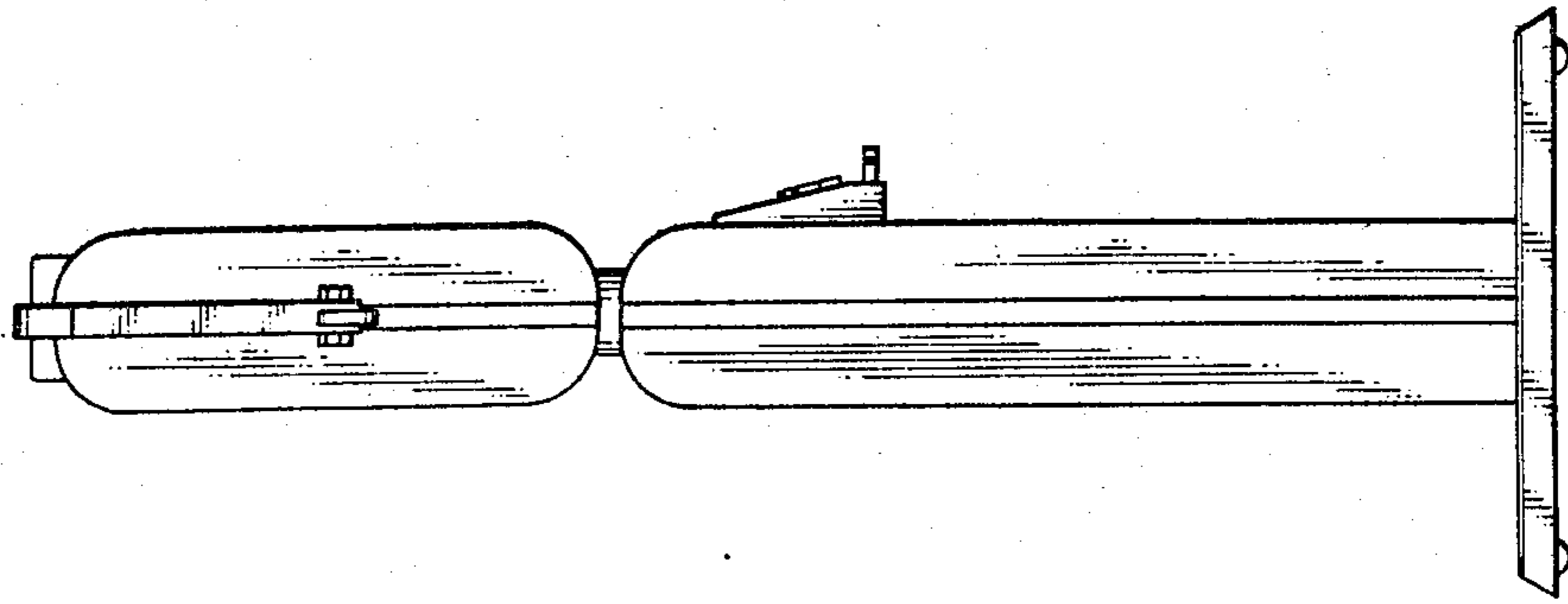

FIG. 6

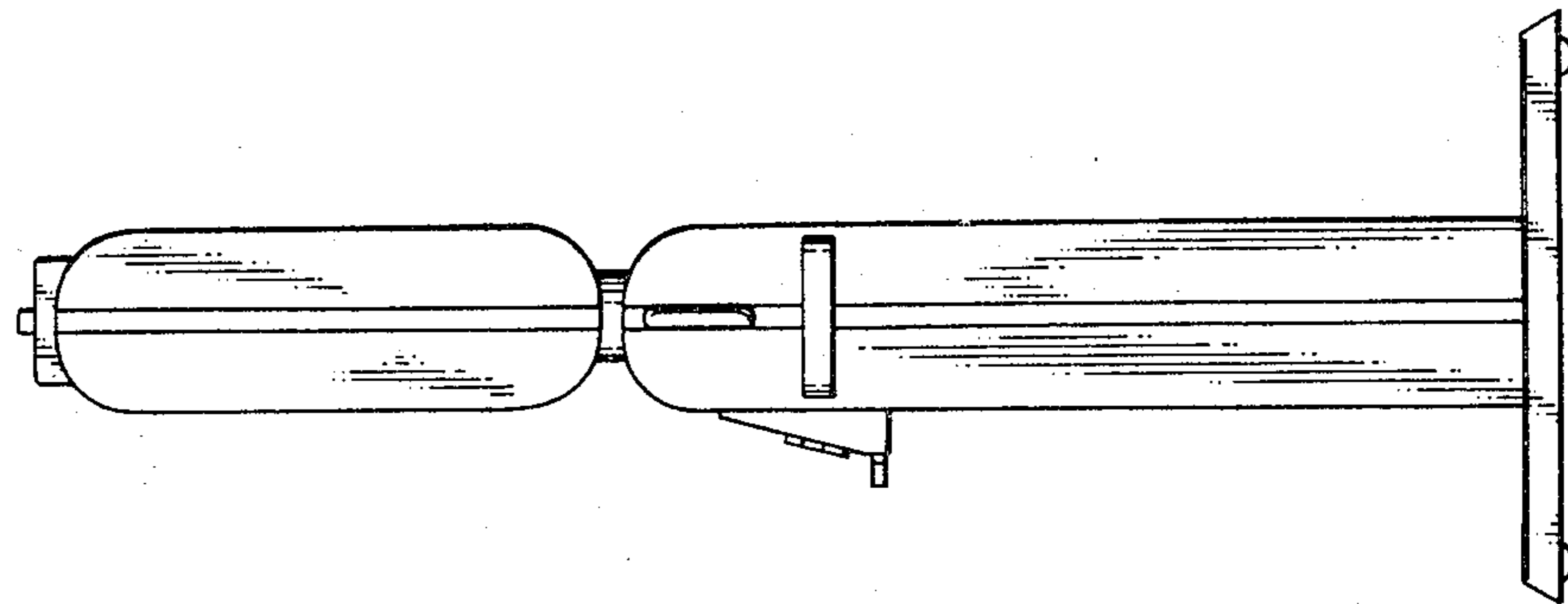

FIG. 3

