

[54] APPARATUS FOR AESTHETIC TREATMENTS OF FACE AND BODY

[75] Inventor: Koichi Takigawa, Tokyo, Japan

[73] Assignee: Takigawa Kabushiki-Kaisha, Tokyo, Japan

[**] Term: 14 Years

[21] Appl. No.: 626,550

[22] Filed: Jul. 2, 1984

[52] U.S. Cl. D28/9; D24/40

[58] Field of Search D28/9, 10, 11, 99; D24/36, 40; 132/1 R, 9; 219/222

[56] References Cited

U.S. PATENT DOCUMENTS

D. 169,491	5/1953	Isham	D24/40
2,384,670	9/1945	Fisher et al.	D24/40 X
3,043,310	7/1962	Milinowski	D24/40 X

OTHER PUBLICATIONS

Modern Salon, 6/1983, p. 97—Bodytone Labs ad at right.

Modern Salon, 9/1983, p. 7—Esty 2000 Console at center left.

Primary Examiner—Louis S. Zarfes
Attorney, Agent, or Firm—Ladas & Parry

[57] CLAIM

The ornamental design for an apparatus for aesthetic treatments of face and body, as shown.

DESCRIPTION

FIG. 1 is a top isometric view of an apparatus for aesthetic treatments of face and body embodying our new design;

FIG. 2 is a top plan view thereof;

FIG. 3 is a front elevational view thereof;

FIG. 4 is a rear elevational view thereof;

FIG. 5 is a bottom plan view thereof;

FIG. 6 is a right and elevational view thereof; and

FIG. 7 is a left and elevational view thereof.

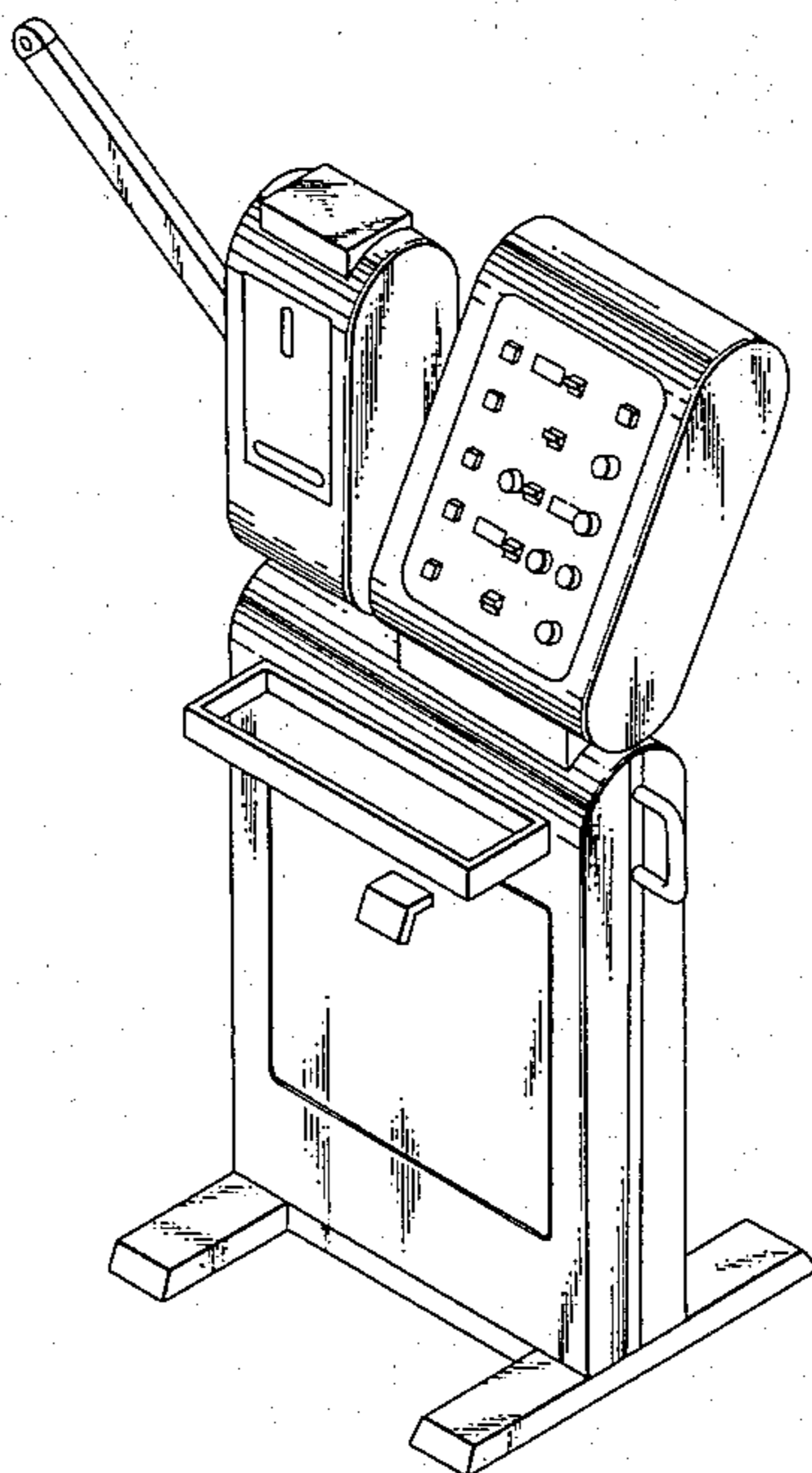

FIG. 1

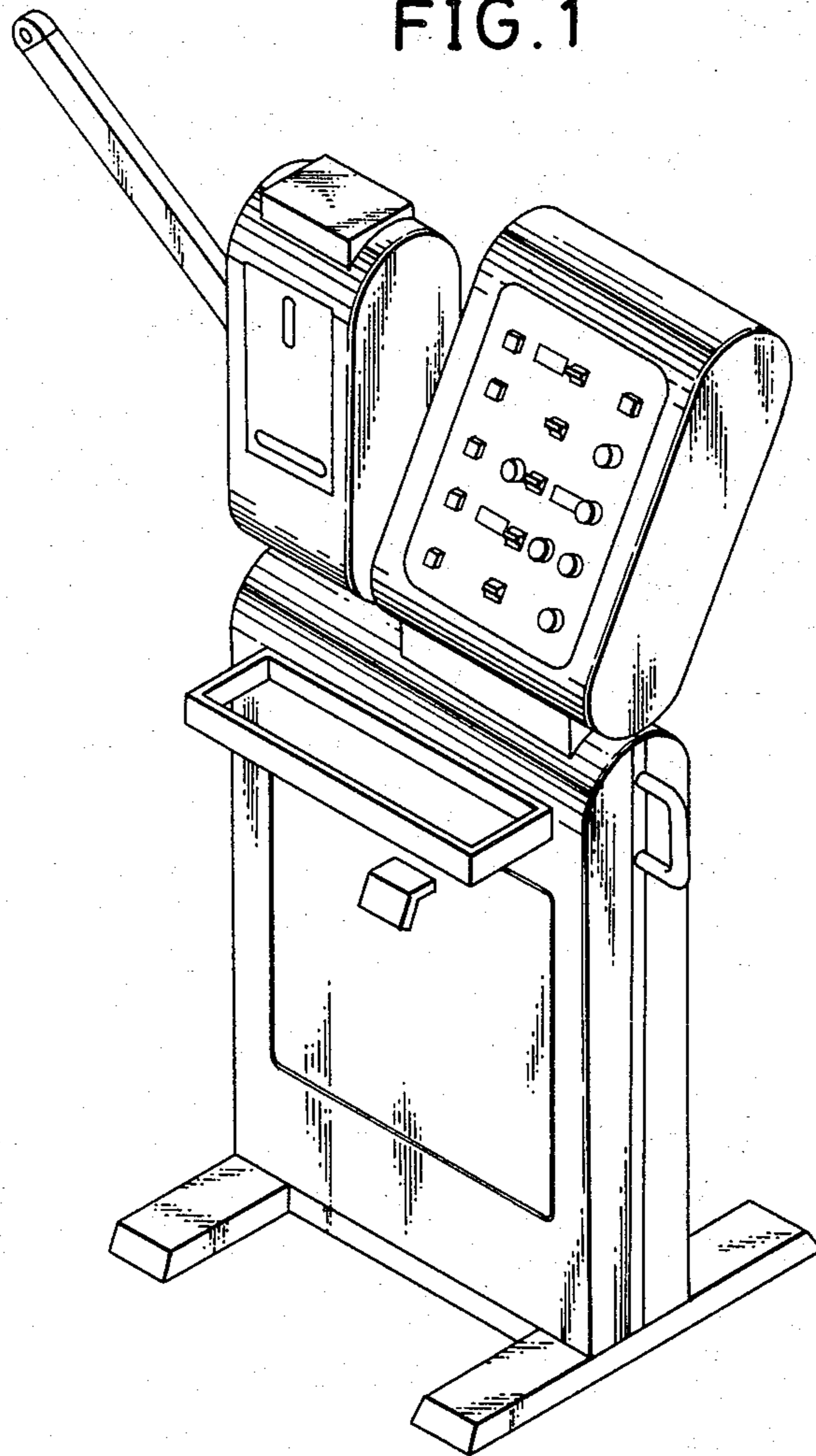

FIG. 4

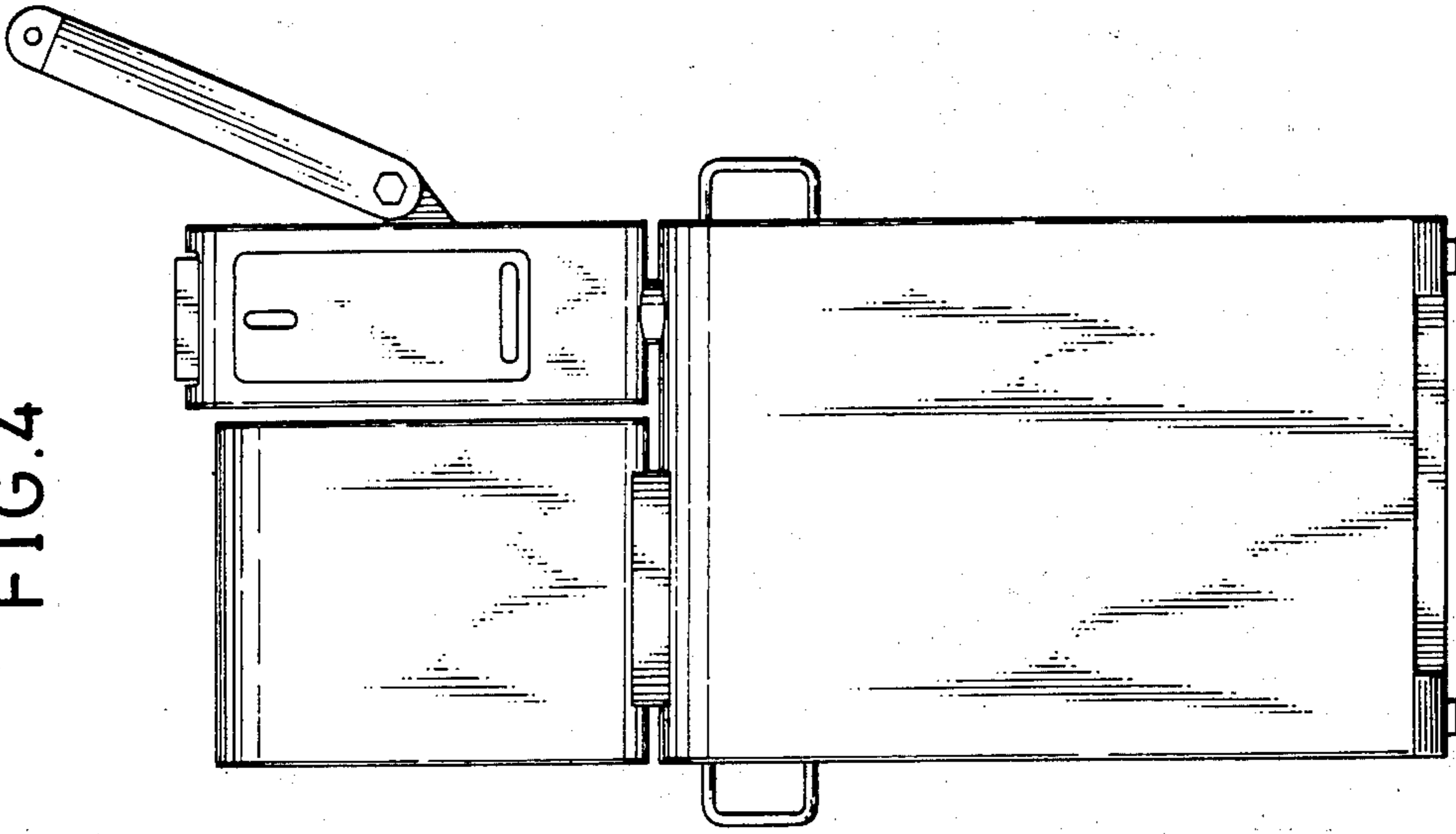

FIG. 2

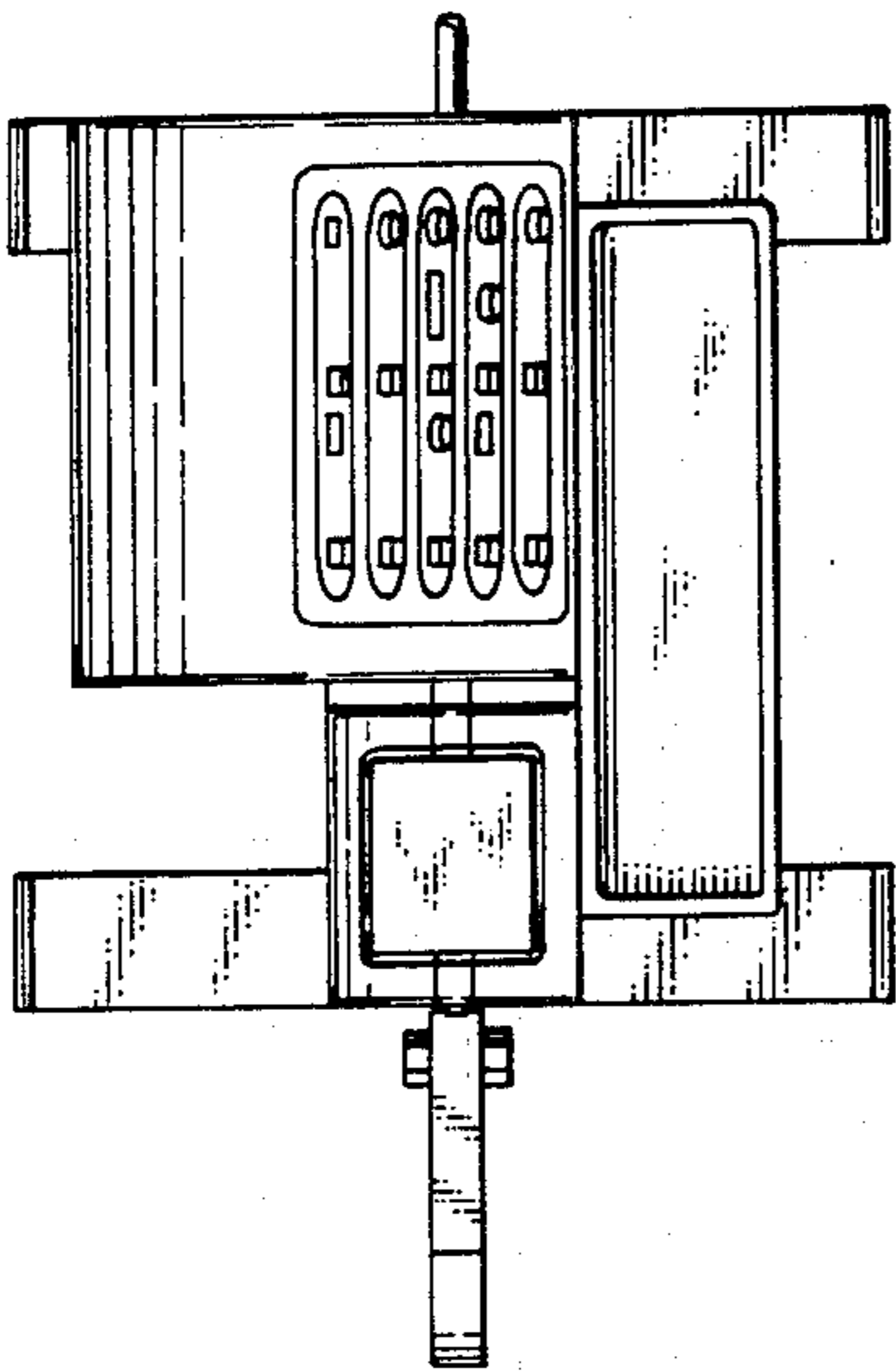

FIG. 5

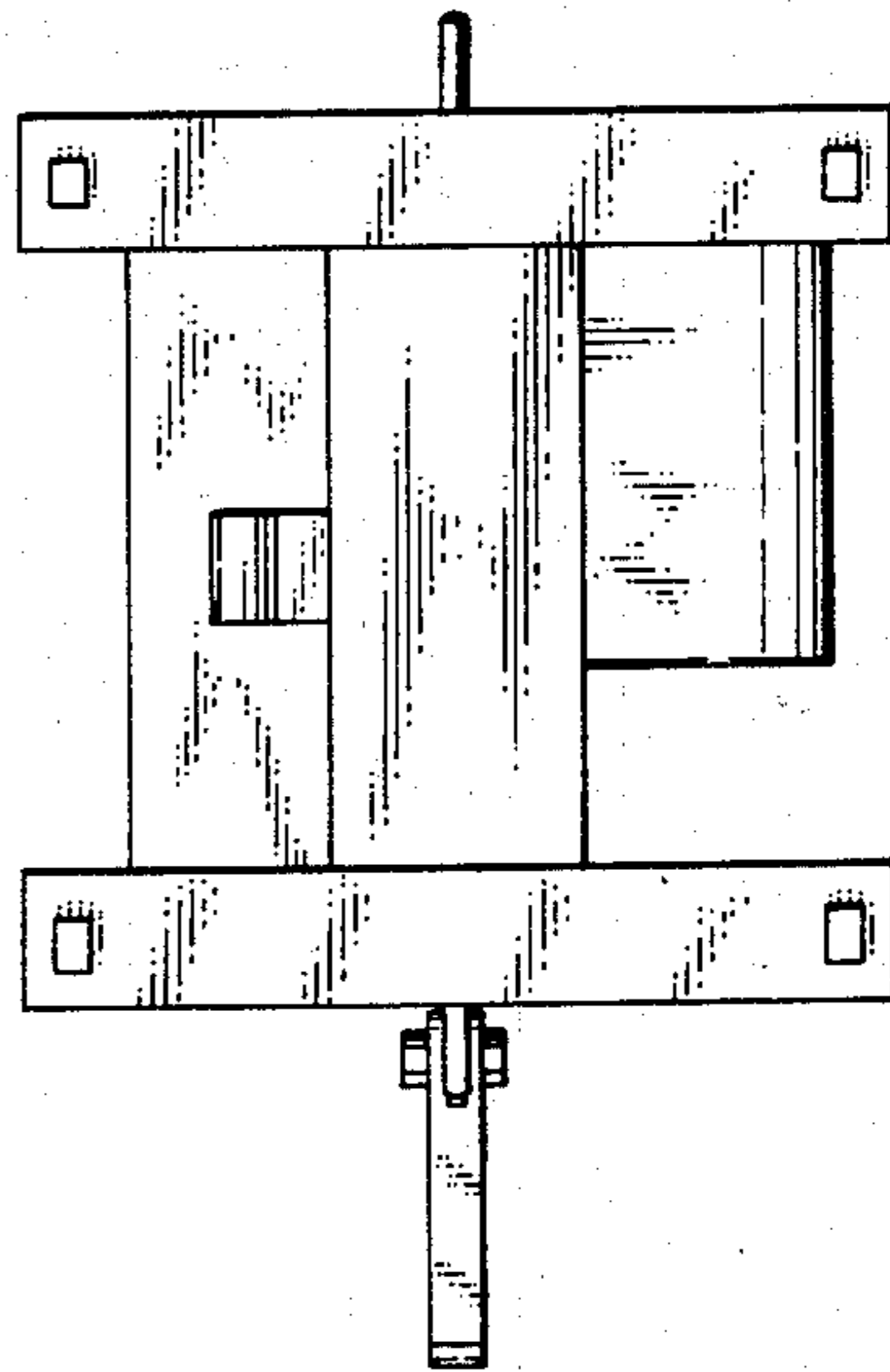

FIG. 7

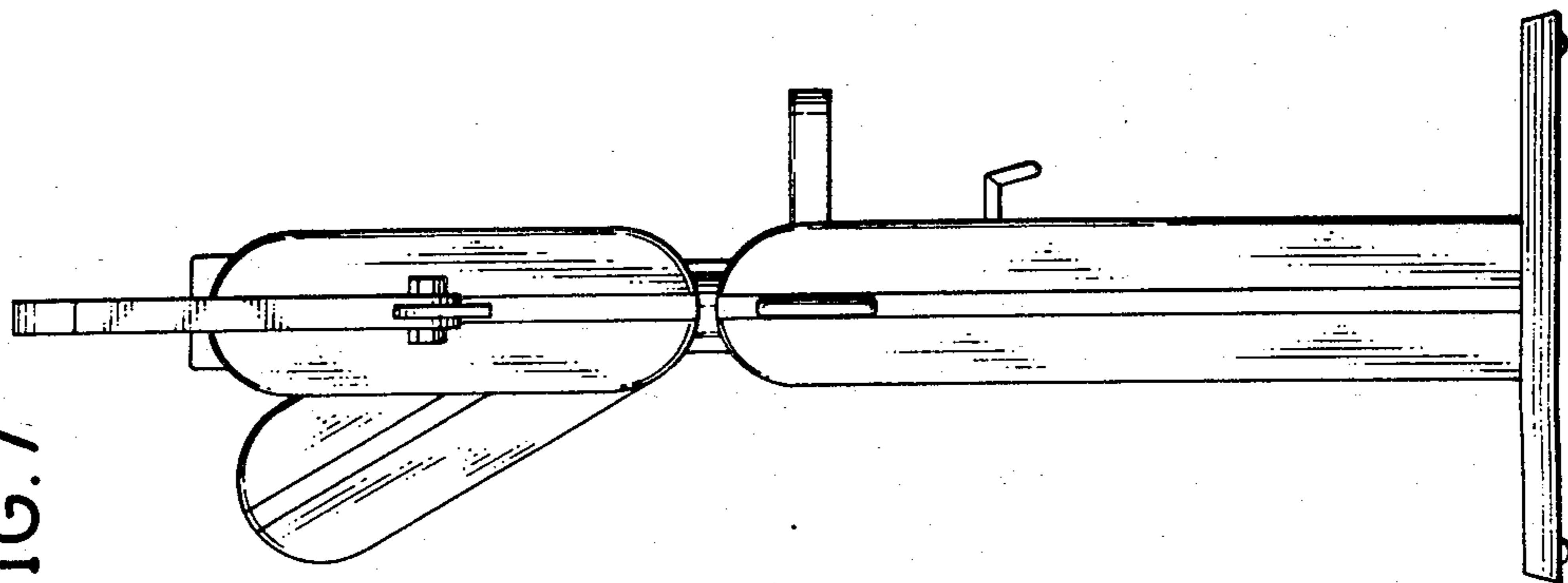

FIG. 6

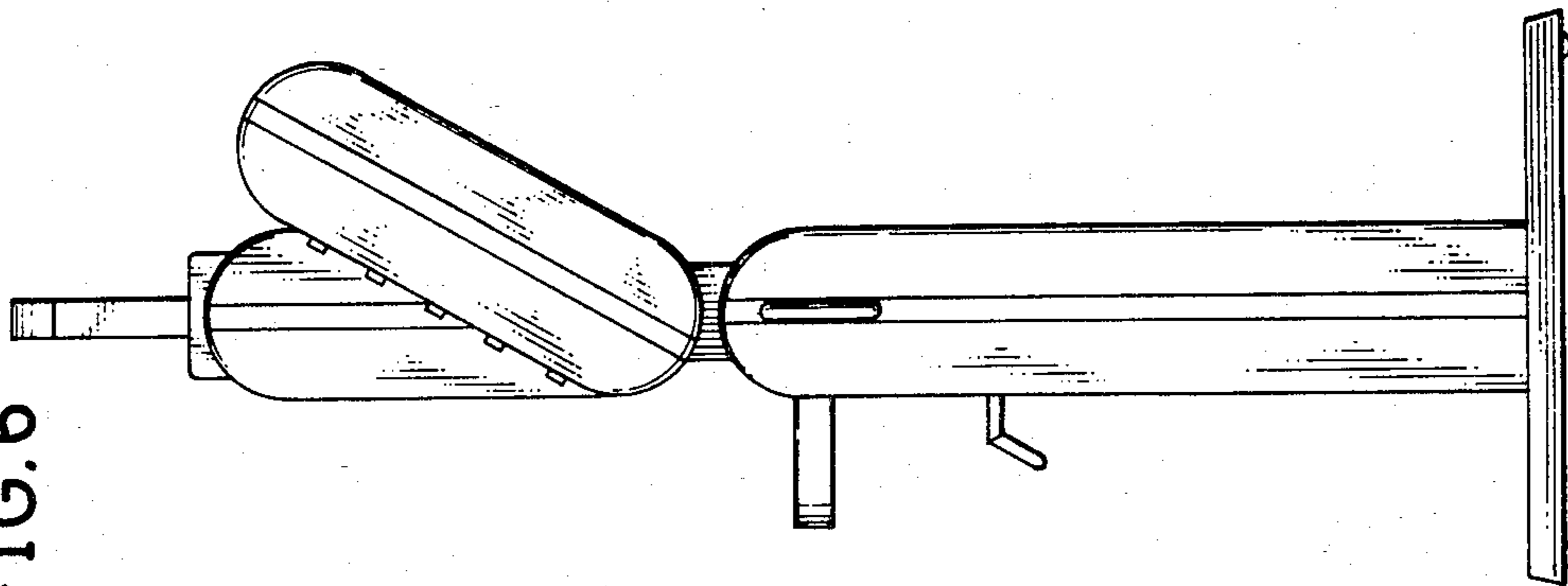

FIG. 3

