

[54] ELECTRIC HOT BEVERAGE MAKER

2,767,640 10/1956 Holland D7/310 X
4,069,751 1/1978 Gronwick et al. D7/310 X

[75] Inventor: Monte L. Levin, New York, N.Y.

[73] Assignee: Hamilton Beach Inc., Waterbury, Conn.

[**] Term: 14 Years

[21] Appl. No.: 630,753

[22] Filed: Jul. 13, 1984

[52] U.S. Cl. D7/309; D7/305; D7/319

[58] Field of Search D7/308, 309, 310, 311, D7/300, 319, 305

[56] References Cited

U.S. PATENT DOCUMENTS

- D. 181,266 10/1957 Alvarez D7/311 X
- D. 201,949 8/1965 Bloomfield D7/309
- D. 234,285 2/1975 Wickenberg D7/309
- D. 253,387 11/1979 Tomaro D7/309

OTHER PUBLICATIONS

Home Furnishings Daily, Jul. 14, 1975, Sec. 2, p. 24, Drip Coffeemaker, The Metal Ware Corp.

Home Furnishings Daily, May 14, 1971, Sec. I, p. 13, Wall-Mounted Coffeemaker, Kristian Kirk Elec., Ltd., "Kirk Automatic".

Primary Examiner—Winifred E. Herrmann
Attorney, Agent, or Firm—Dallett Hoopes

[57] CLAIM

The ornamental design for an electric hot beverage maker, substantially as shown.

DESCRIPTION

FIG. 1 is a perspective view showing my new design; FIG. 2 is a top plan view; FIG. 3 is a front elevational view; FIG. 4 is a side elevational view; and FIG. 5 is a rear elevational view.

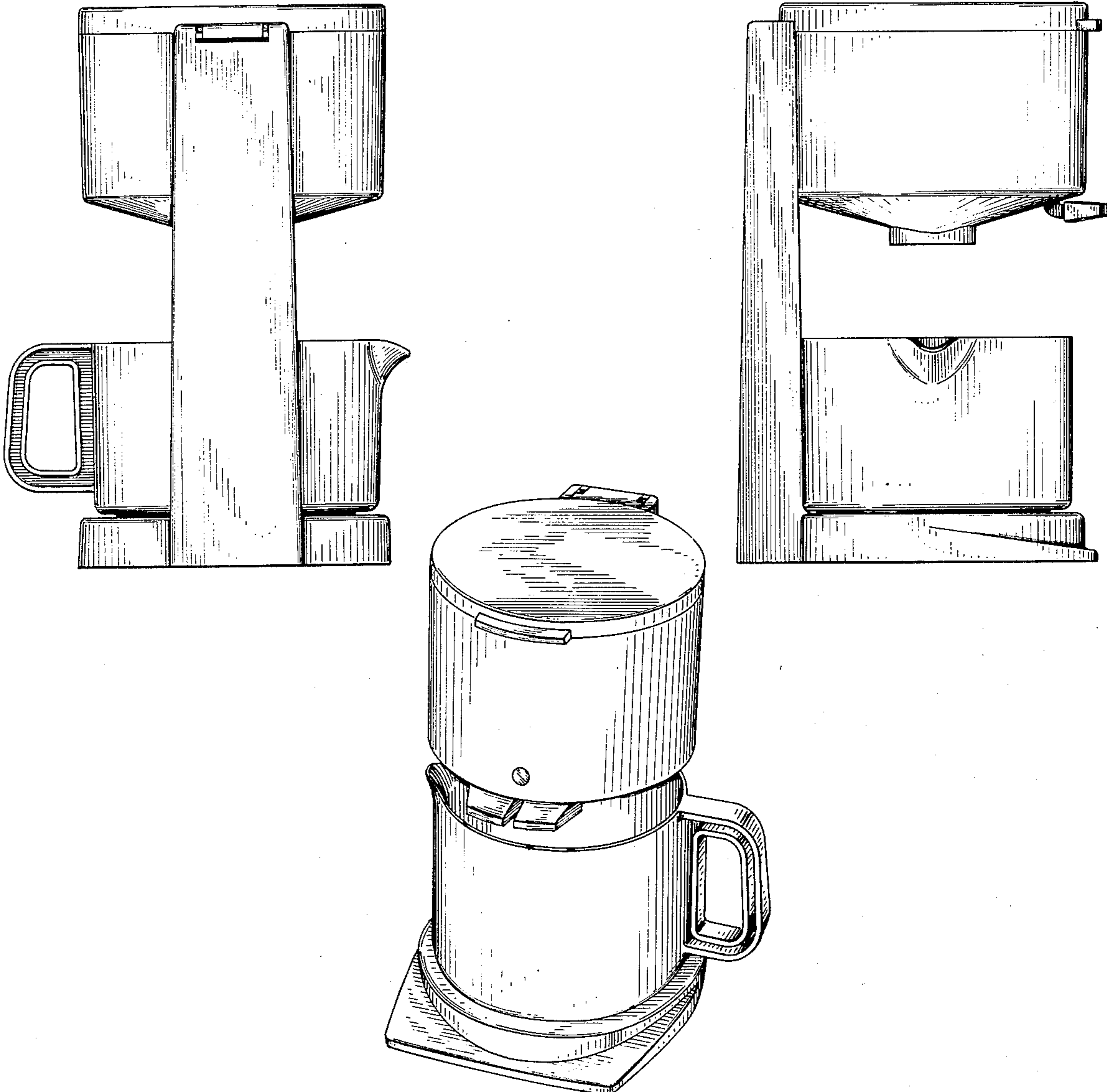

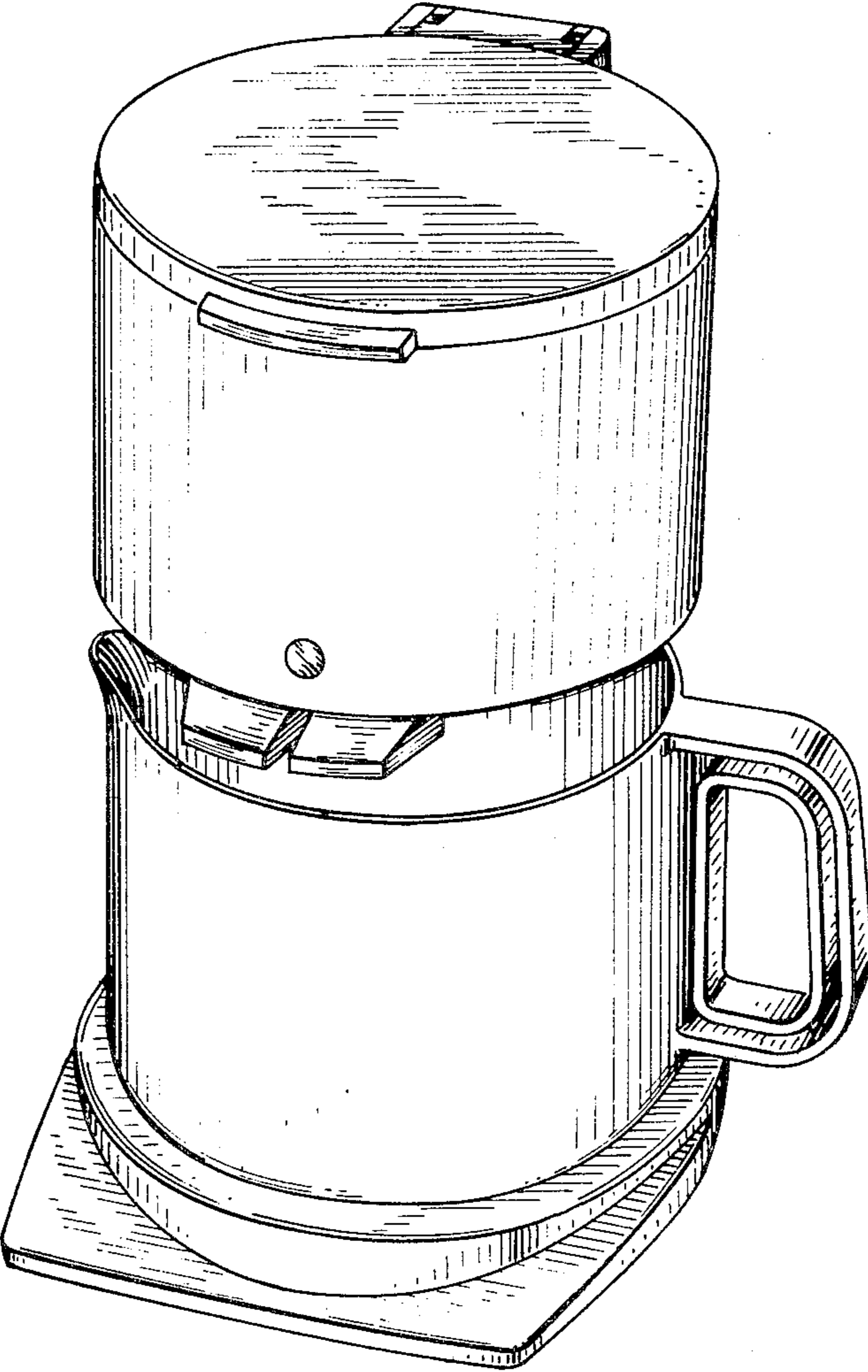

Fig. 1

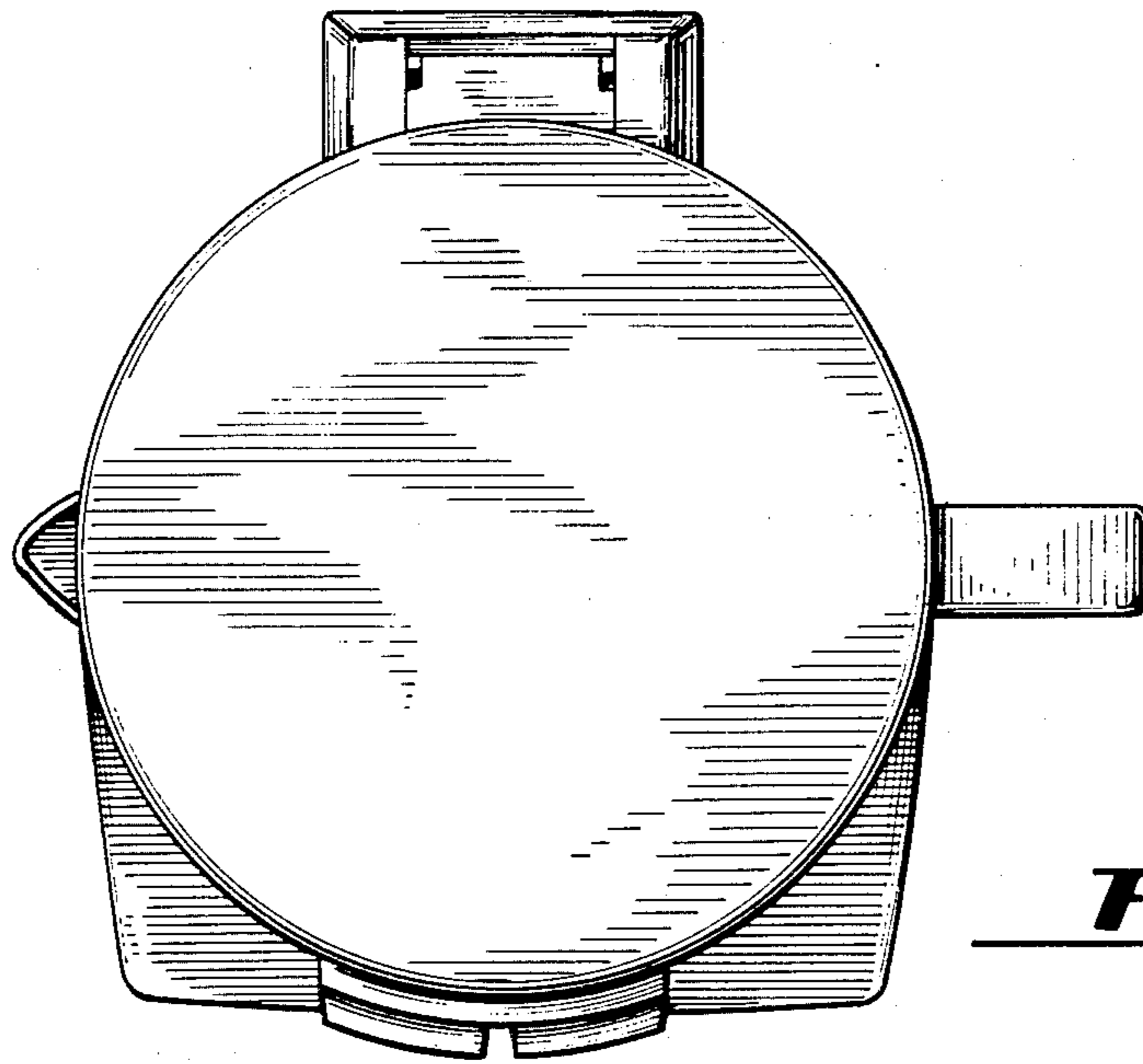

Fig. 2

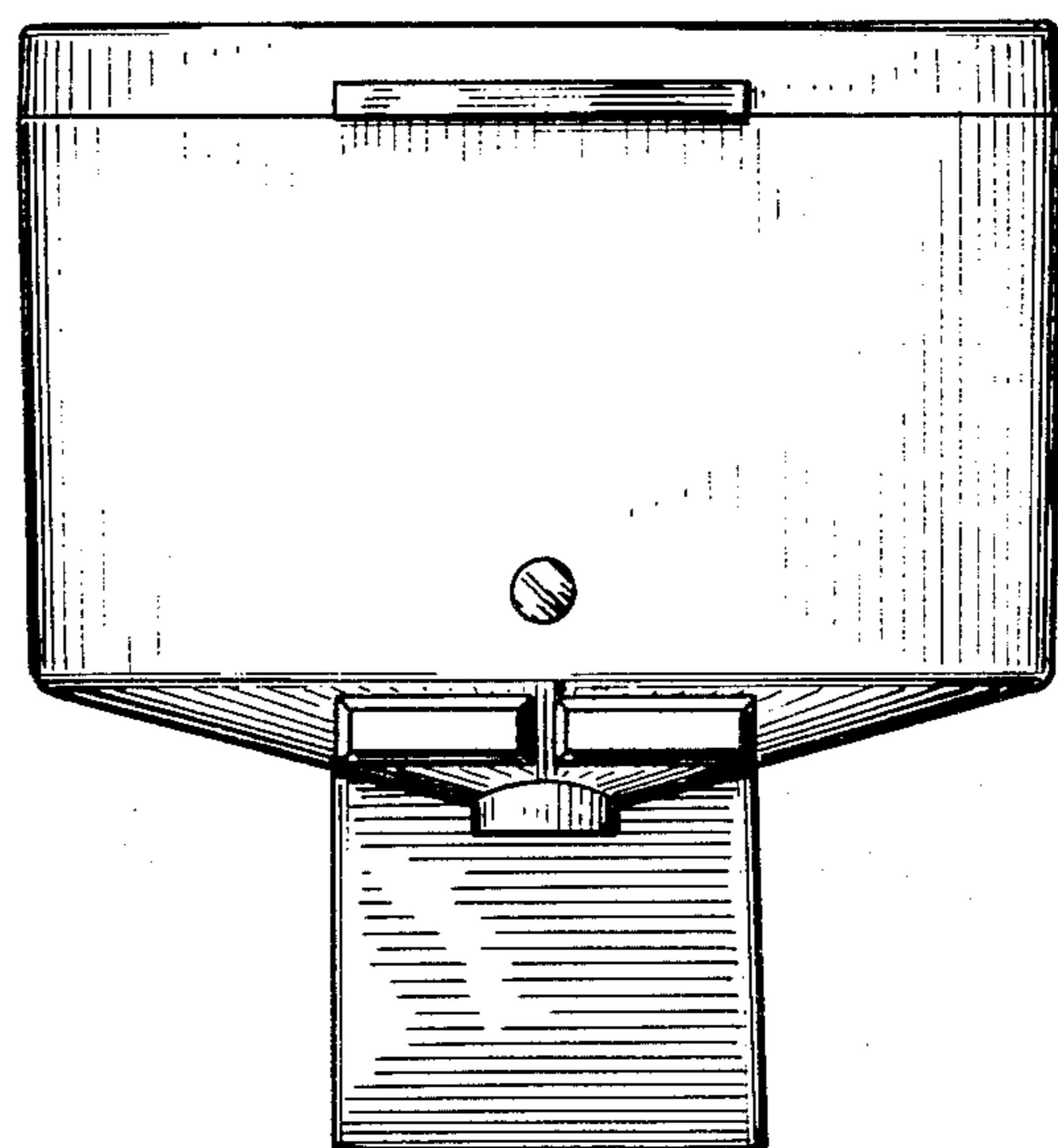
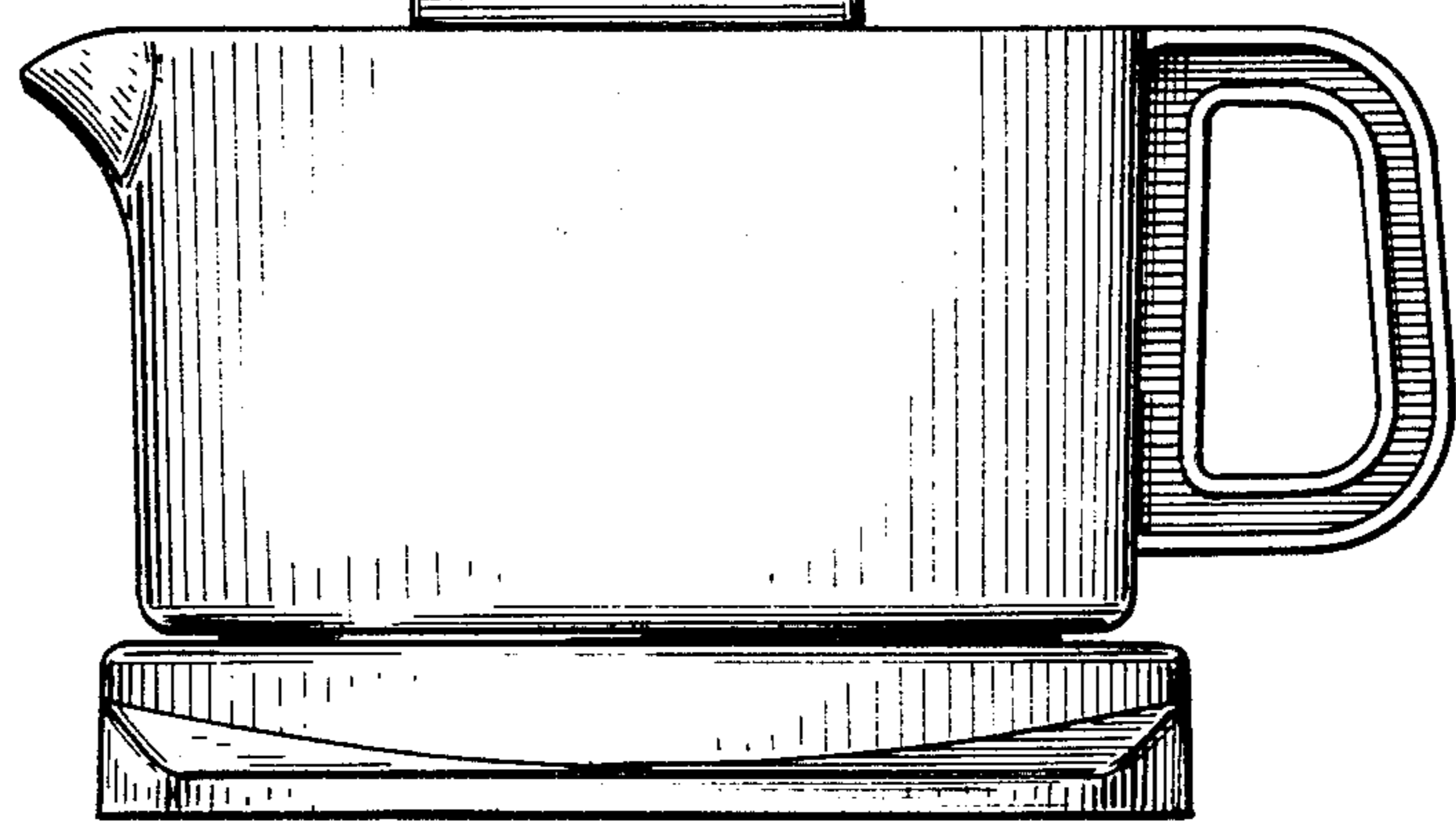

Fig. 3



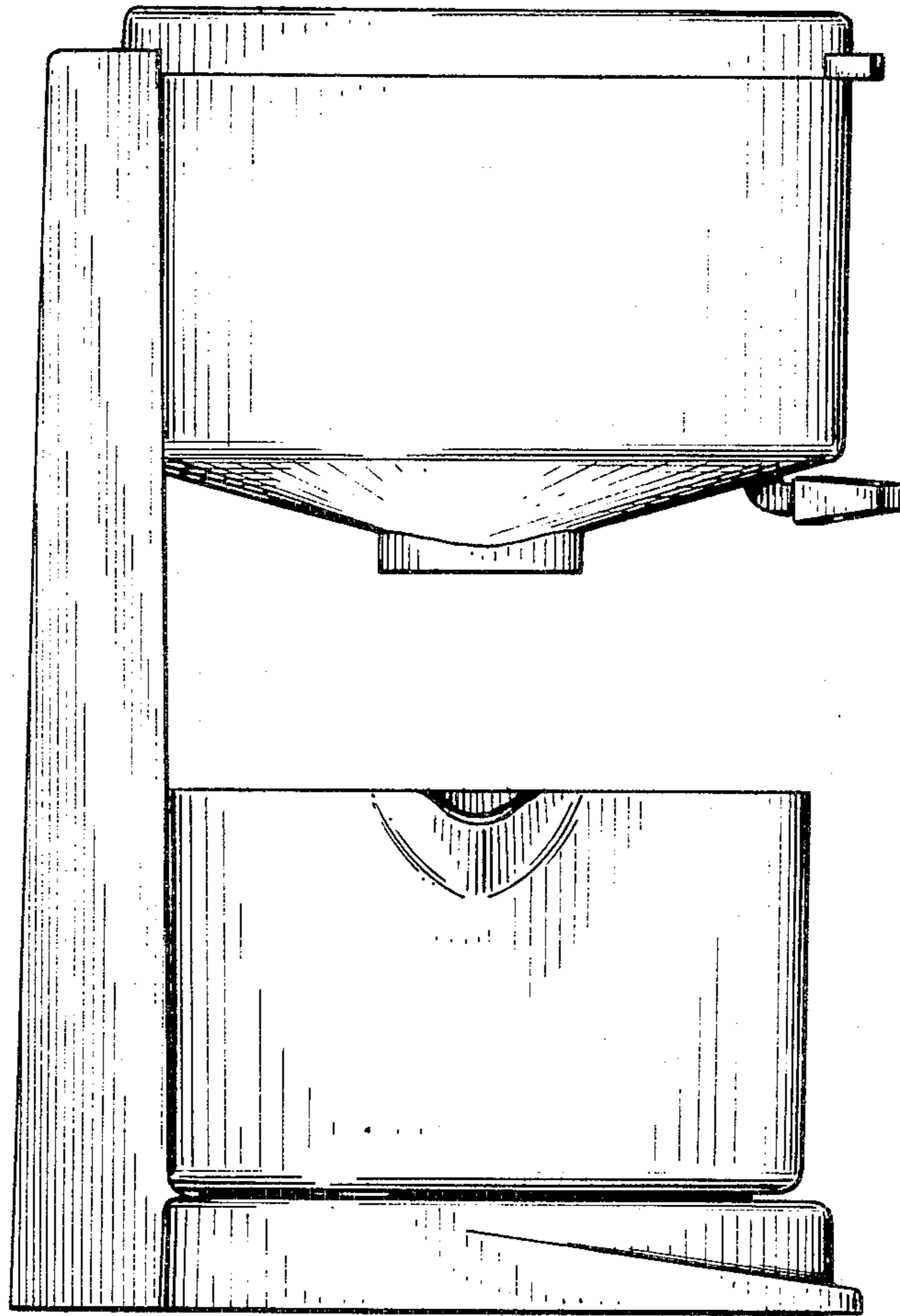

Fig. 4

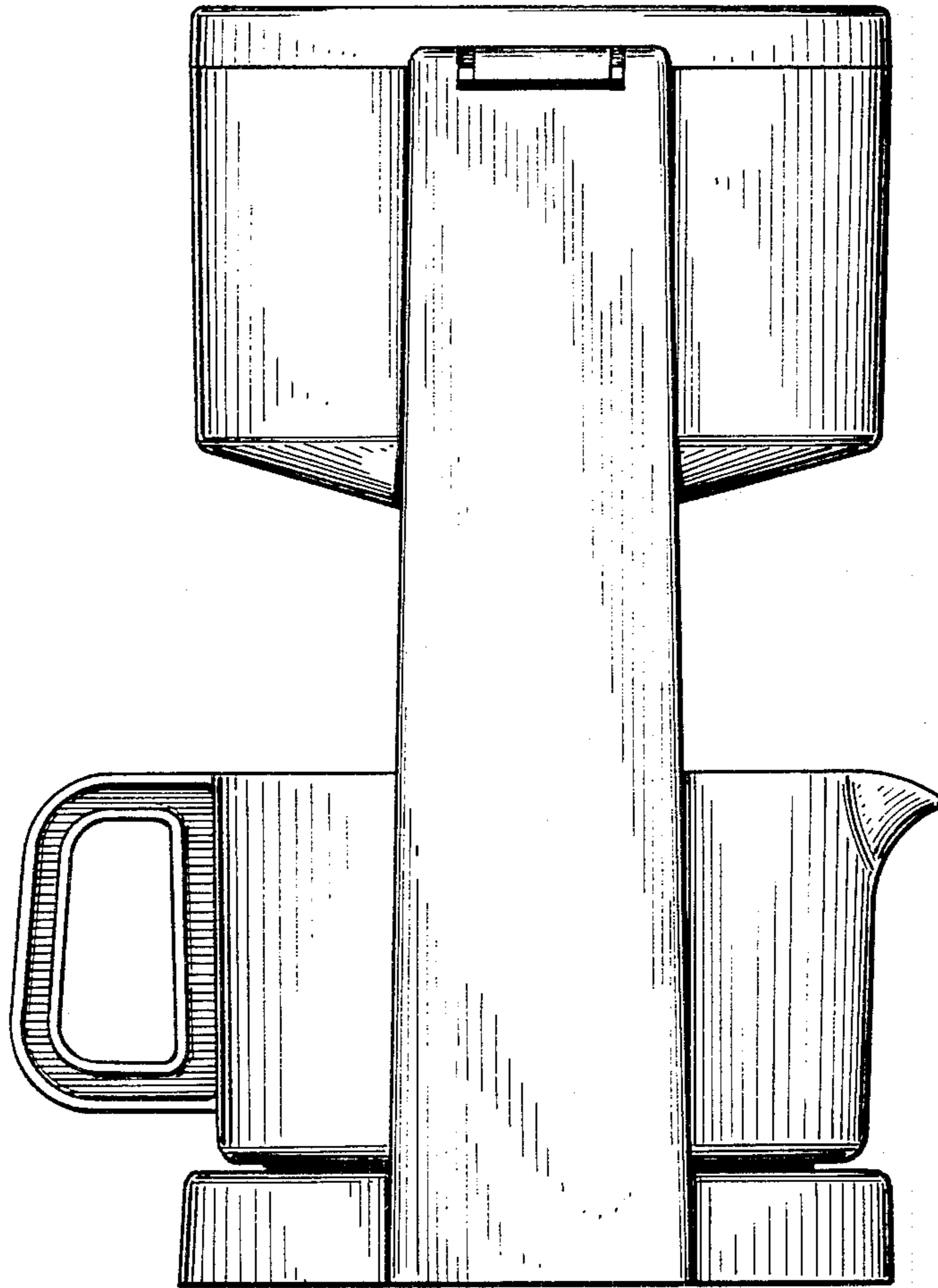

Fig. 5