

[54] PURGING PUMP FOR PLUMBING SYSTEMS

4,445,236 5/1984 Nadolny et al. .... 4/255

[75] Inventor: Desmond C. Drummond, Newmarket, England

Primary Examiner—Wallace R. Burke  
Assistant Examiner—Brian N. Vinson  
Attorney, Agent, or Firm—Staas & Halsey

[73] Assignee: Desmond C. Drummond, Suffolk, England

[57] CLAIM

[\*\*] Term: 14 Years

The ornamental design for a purging pump for plumbing systems, as shown and described.

[21] Appl. No.: 631,292

DESCRIPTION

[22] Filed: Jul. 16, 1984

[52] U.S. Cl. .... D23/15

FIG. 1 is a front elevation of a purging pump for plumbing systems showing my new design, the rear elevation being substantially identical;

[58] Field of Search ..... D23/14-16; 4/255-257; D32/35

FIG. 2 is a side elevation thereof, the opposite side being substantially identical;

[56] References Cited

U.S. PATENT DOCUMENTS

D. 202,979	11/1965	Krusche	.....	D32/35
D. 203,345	12/1965	Sukert et al.	.....	D23/18
2,939,154	6/1960	Gasser	.....	4/255
3,644,943	2/1972	Parodi fu Leonardo et al.	.....	4/255
3,952,341	4/1976	Cain	.....	4/255
4,186,451	2/1980	Ruo	.....	4/255

FIG. 3 is a top plan view thereof;

FIG. 4 is a bottom plan view thereof;

FIG. 5 is a front elevation thereof showing the nozzle in an alternate position, the rear elevation being substantially identical;

FIG. 6 is a side elevation of FIG. 5, the opposite side being substantially identical;

FIG. 7 is a top plan view of FIG. 5; and

FIG. 8 is a bottom plan view of FIG. 5.

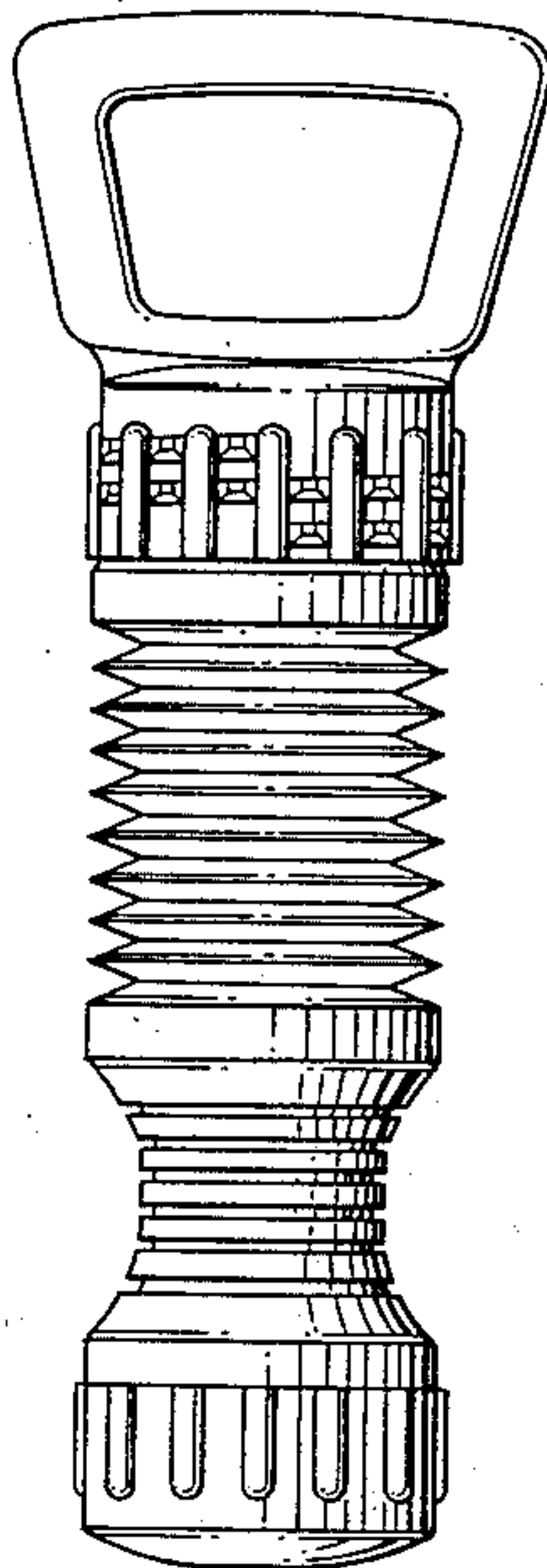

FIG. 1.

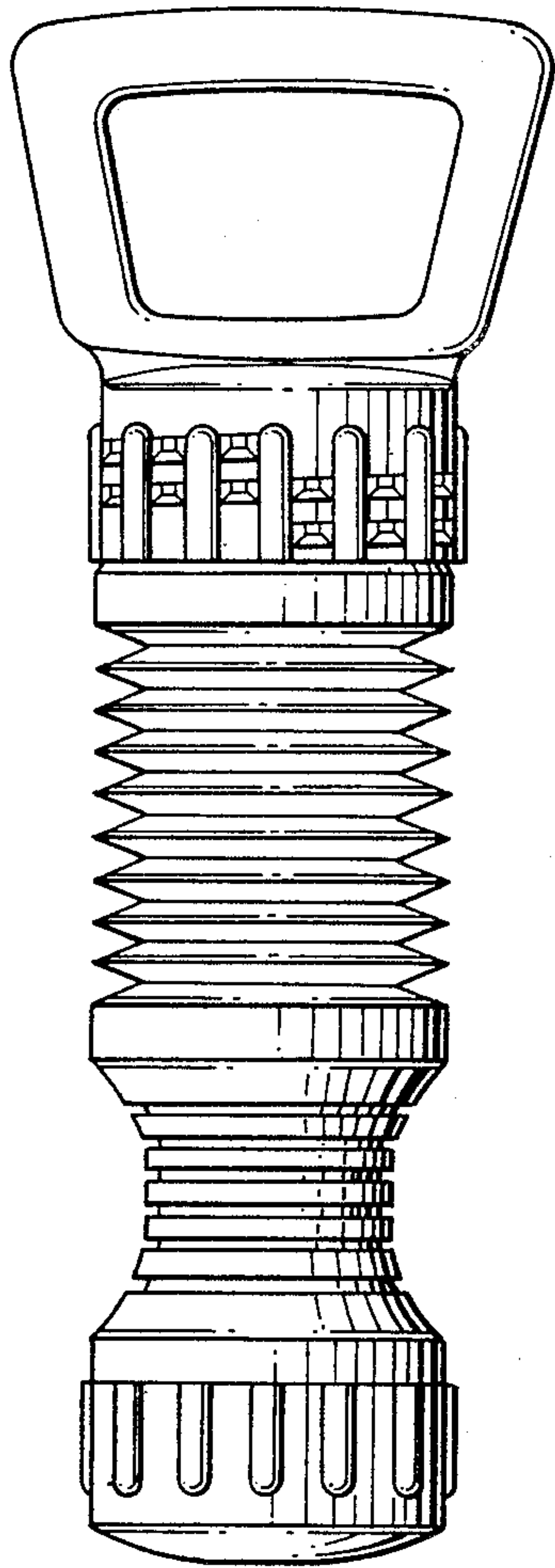

FIG. 2.

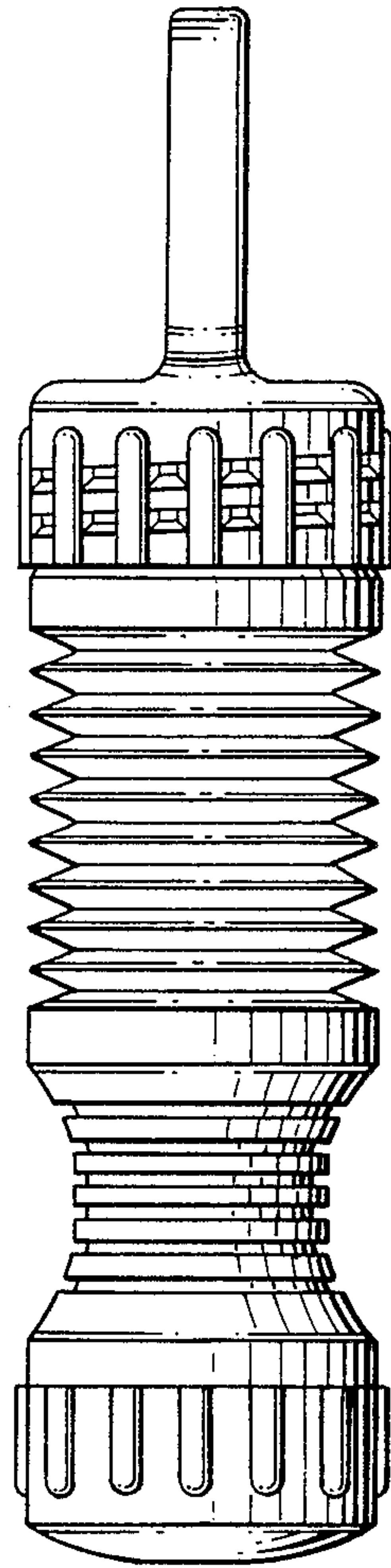

FIG. 3.

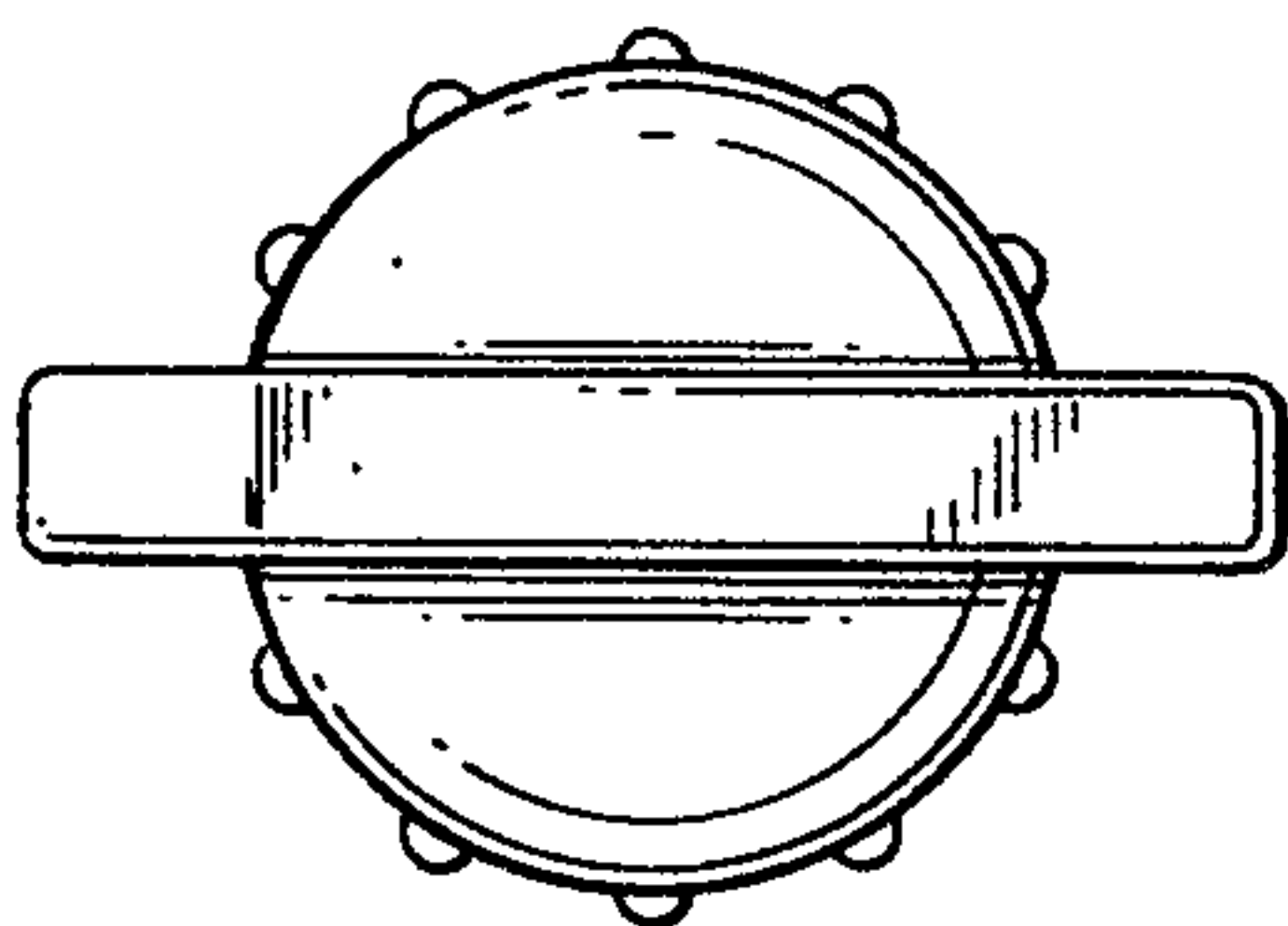

FIG. 4.

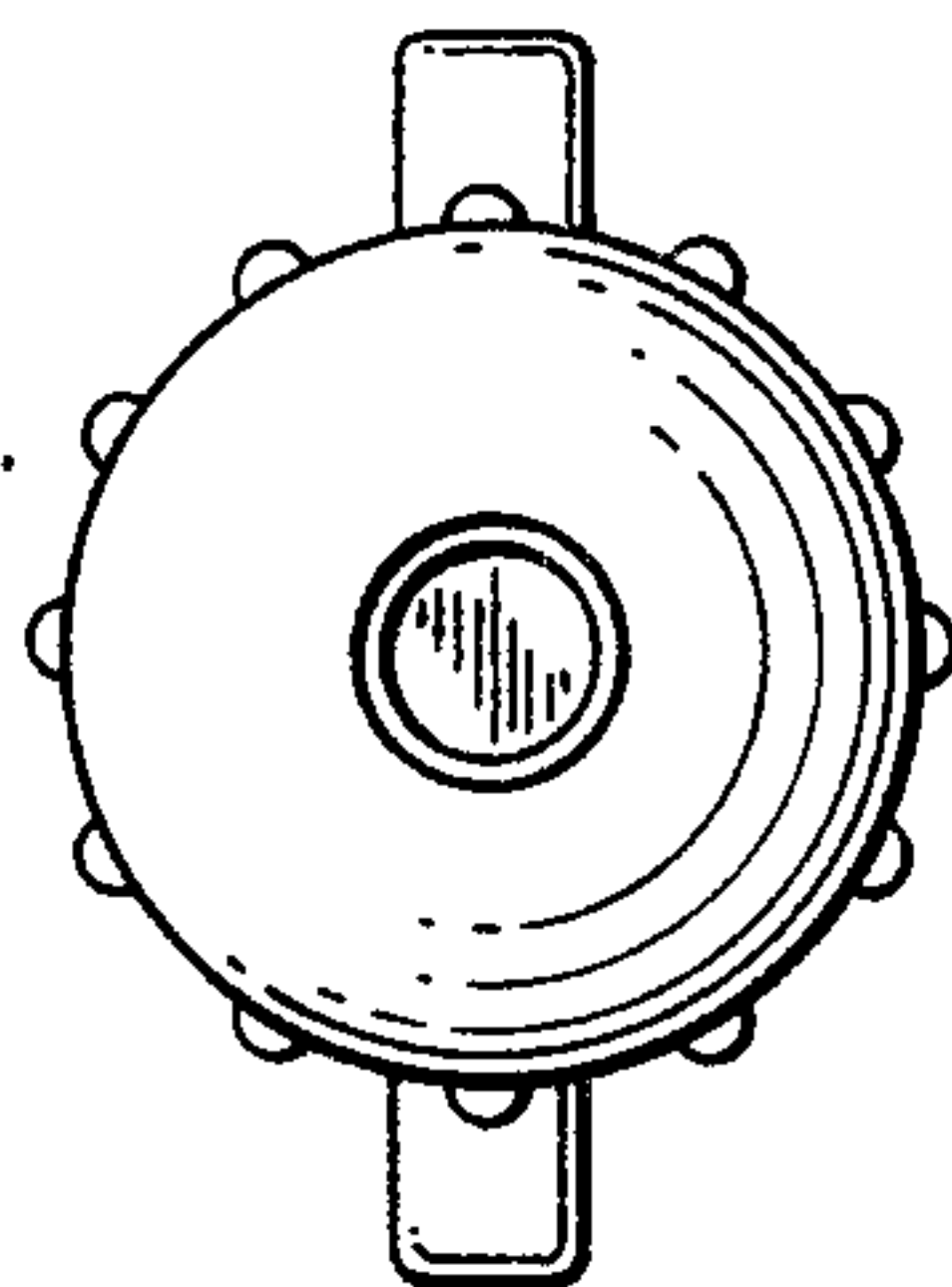

FIG. 5.

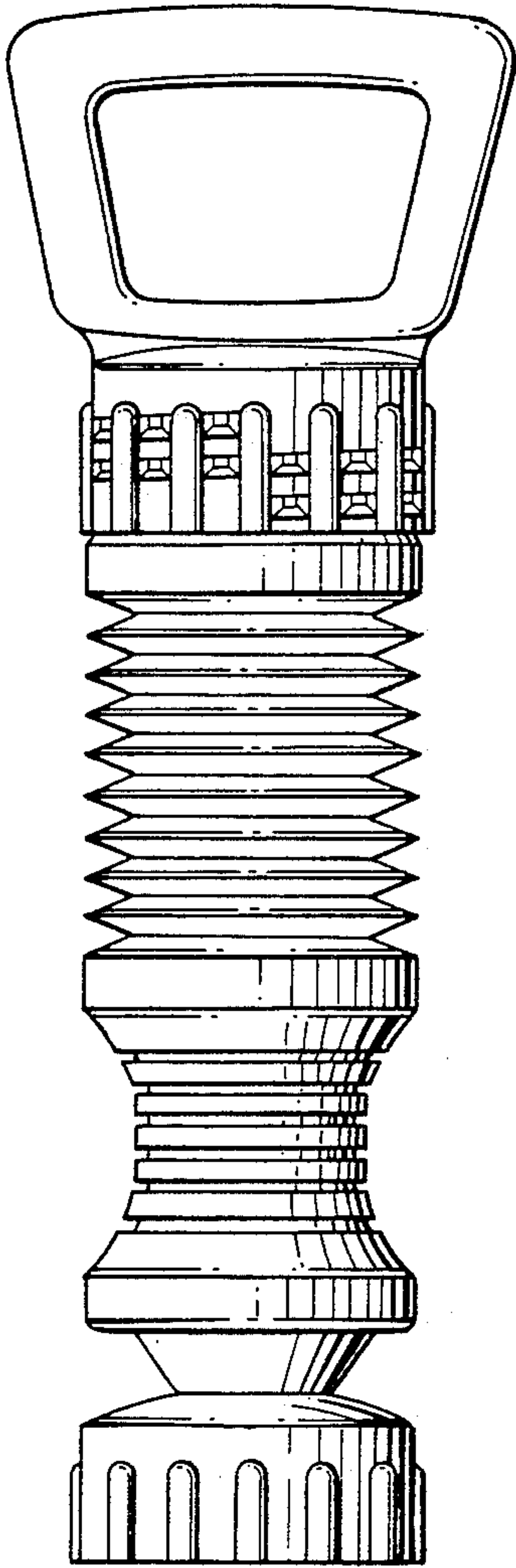

FIG. 6.

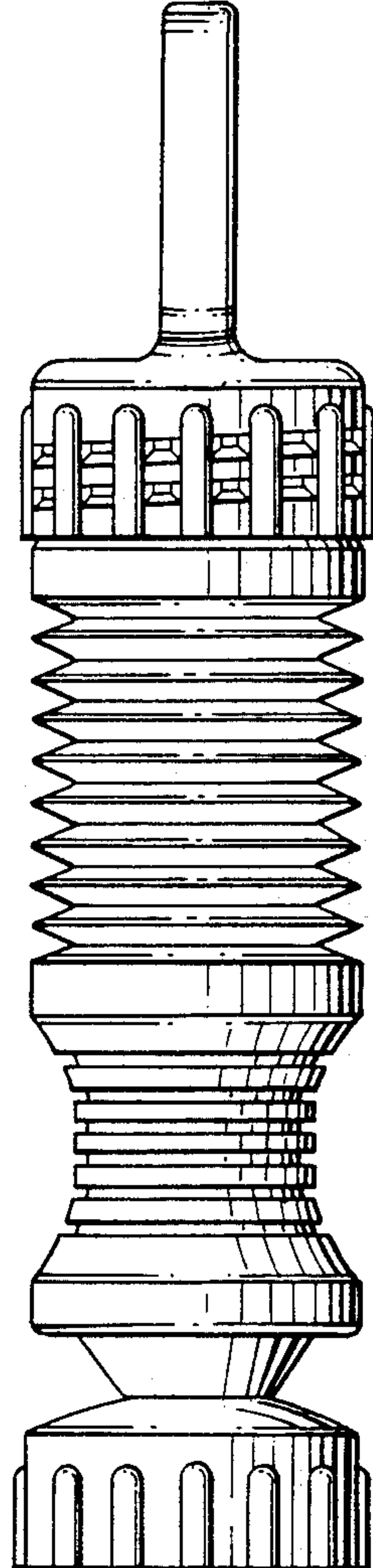

FIG. 7.

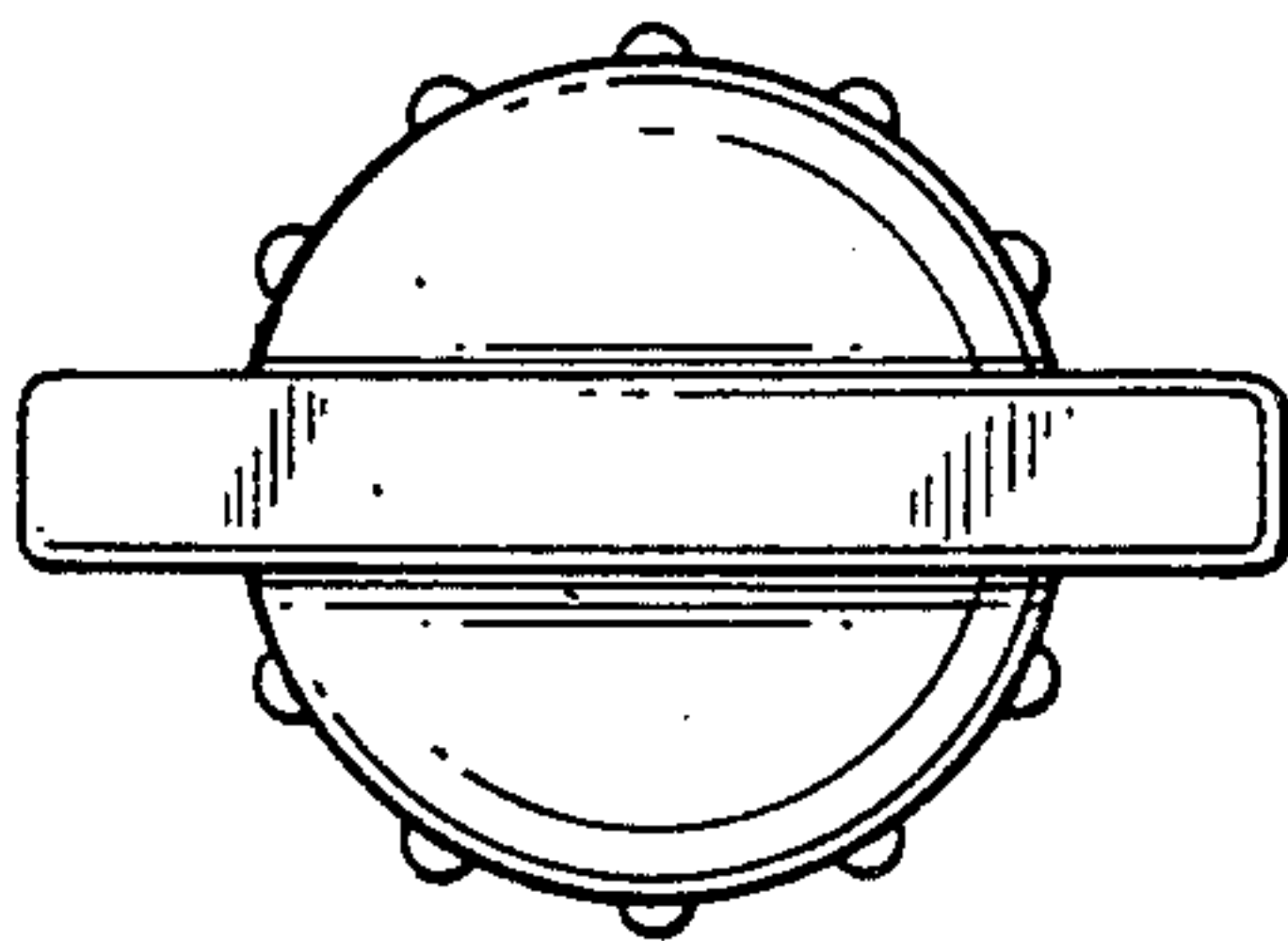

FIG. 8.

