

[54] GOBLET OR SIMILAR ARTICLE

[76] Inventor: Jean-Jacques Durand, LaBute 62510, Arques, France

[\*\*] Term: 14 Years

[21] Appl. No.: 680,794

[22] Filed: Dec. 12, 1984

[52] U.S. Cl. .... D7/11; D9/13

[58] Field of Search ..... D7/6, 11-15

[56] References Cited

U.S. PATENT DOCUMENTS

- D. 77,952 3/1929 Gunthel ..... D7/14 X
- D. 80,810 3/1930 Schaub ..... D7/13
- D. 87,761 9/1932 Smith ..... D7/13
- D. 105,759 8/1937 Cunningham ..... D7/12
- D. 160,354 10/1950 Yutzey ..... D7/12

OTHER PUBLICATIONS

*Fostoria Glass Co. 1936 Cat.*, Jun. 17, 1936, p. 21—"Hermitage Pattern," #2449-4 oz. Claret, left col. 2nd. down.

Primary Examiner—Winifred E. Herrmann  
Attorney, Agent, or Firm—Kimmel, Crowell & Weaver

[57] CLAIM

The ornamental design for a goblet or similar article, substantially as shown and described.

DESCRIPTION

FIG. 1 is a side elevational view of a goblet or similar article showing my new design, the reverse side being a mirror image thereof;

FIG. 2 is a sectional view thereof, taken along the lines 2—2 of FIG. 1, looking in the direction of the arrows;

FIG. 3 is a top plan view thereof;

FIG. 4 is a sectional view thereof, taken along the lines 4—4 of FIG. 1, looking in the direction of the arrows;

FIG. 5 is a sectional view thereof, taken along the lines 5—5 of FIG. 3, looking in the direction of the arrows; and

FIG. 6 is a bottom plan view thereof.

The cut pattern on the bowl portion of the design in FIGS. 1 and 4 that would be visible through the bowl in FIGS. 2, 3, and 5 has been omitted for convenience of illustration.

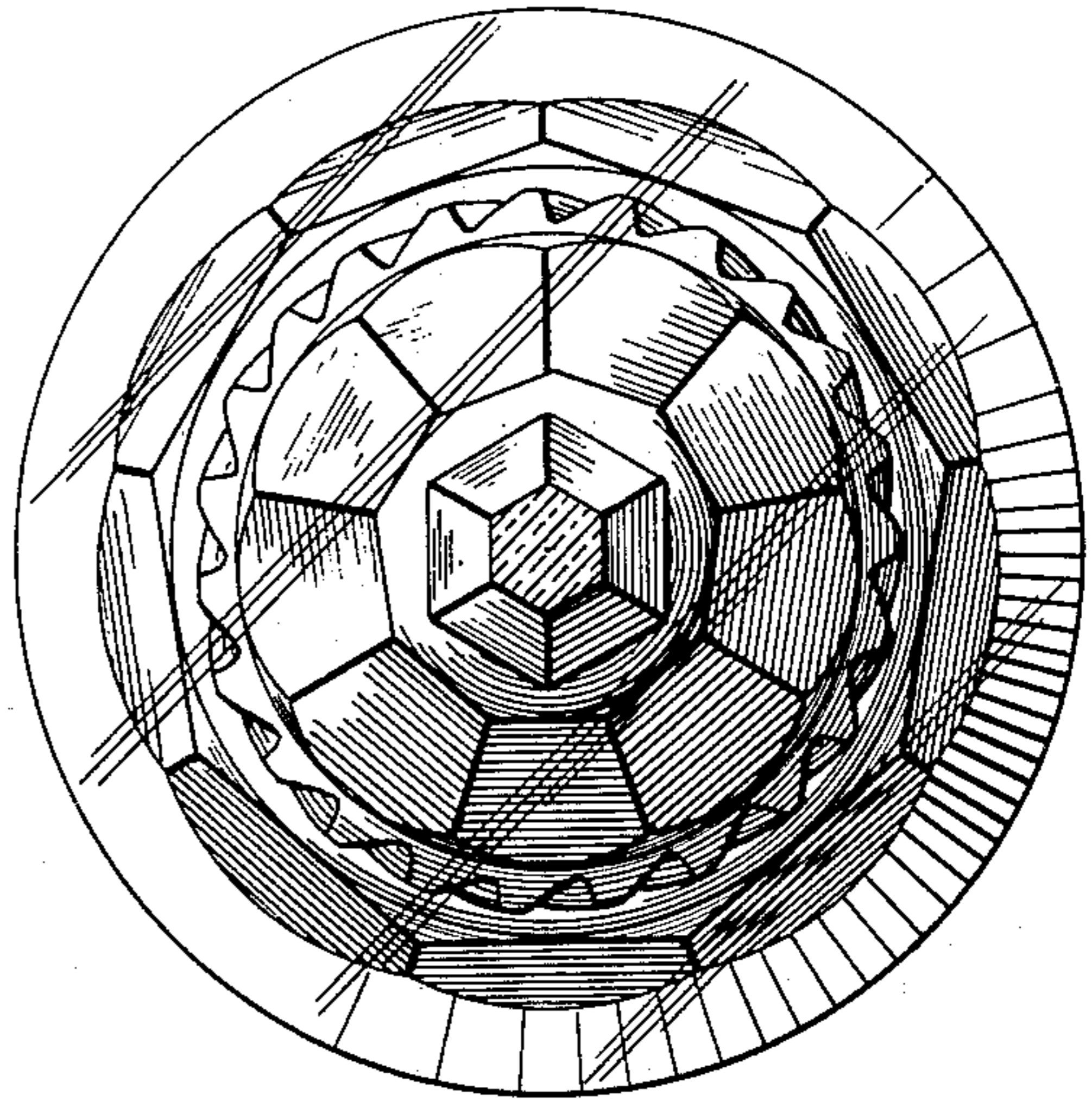
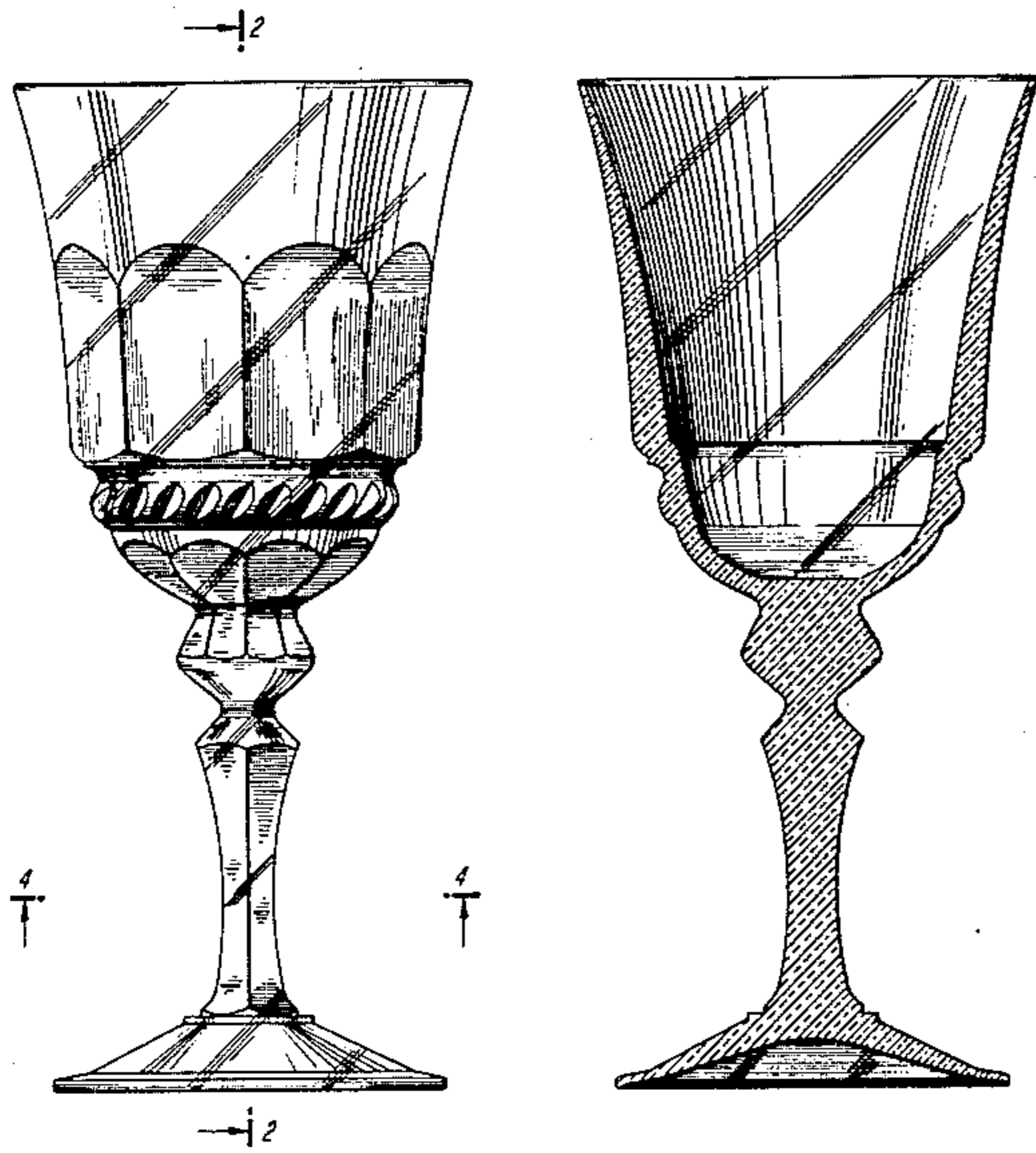

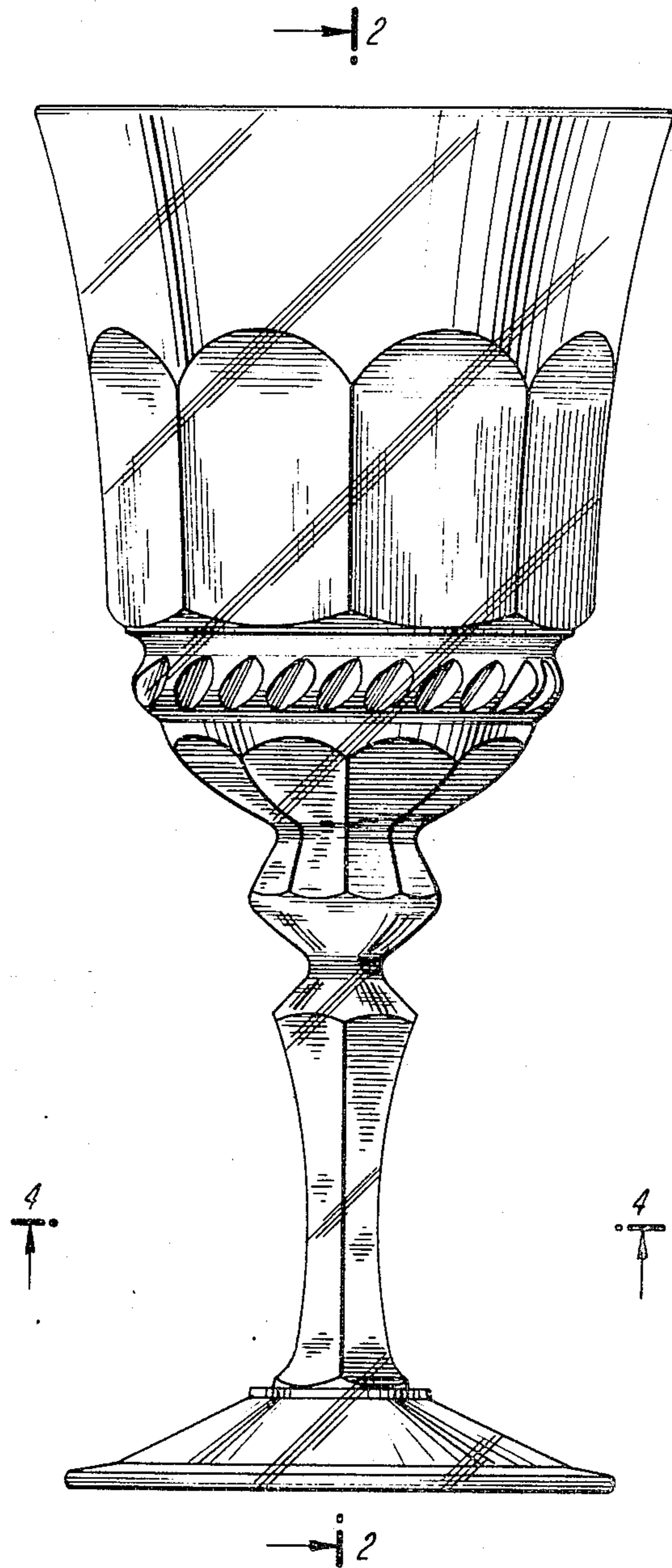

FIG. 1

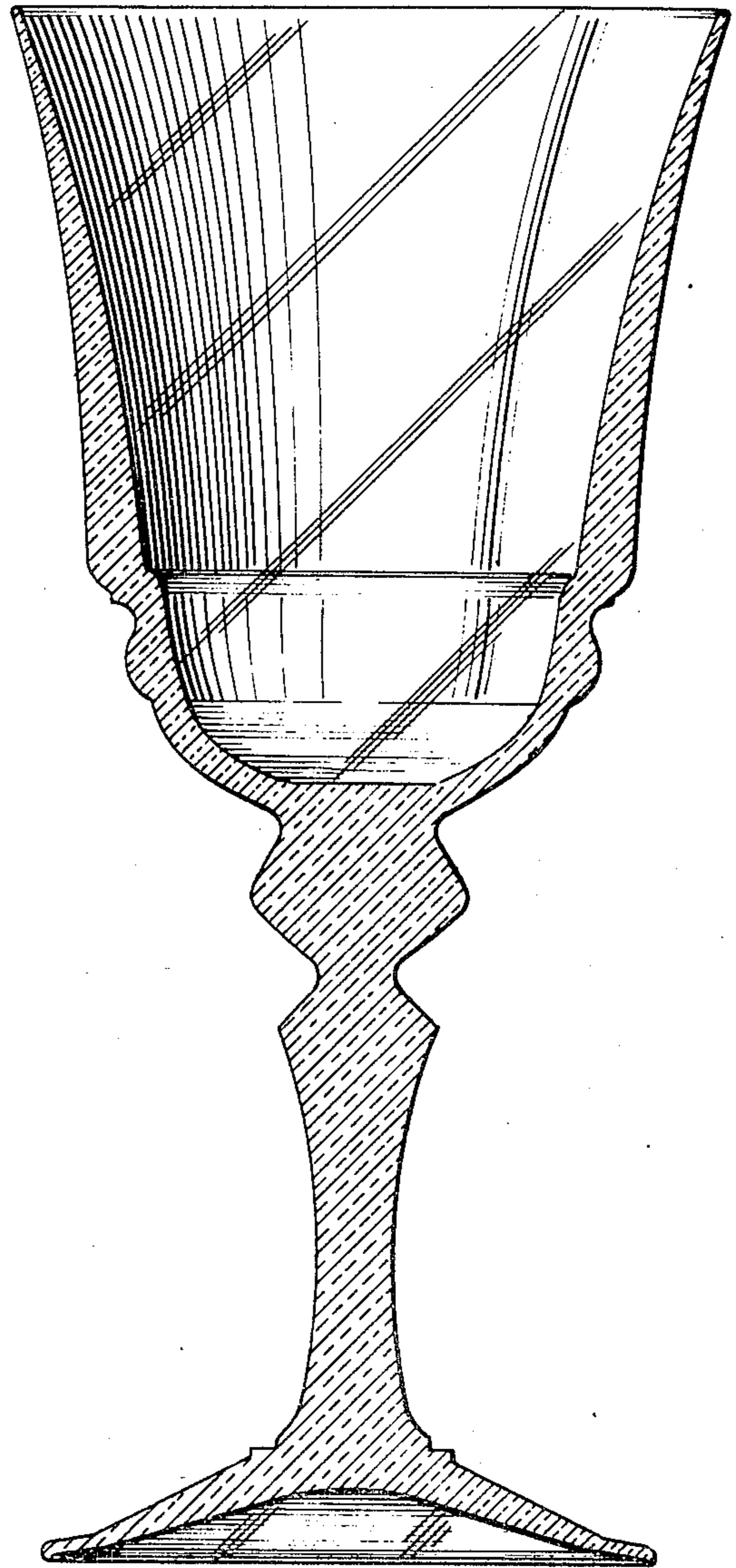

FIG. 2

FIG. 3

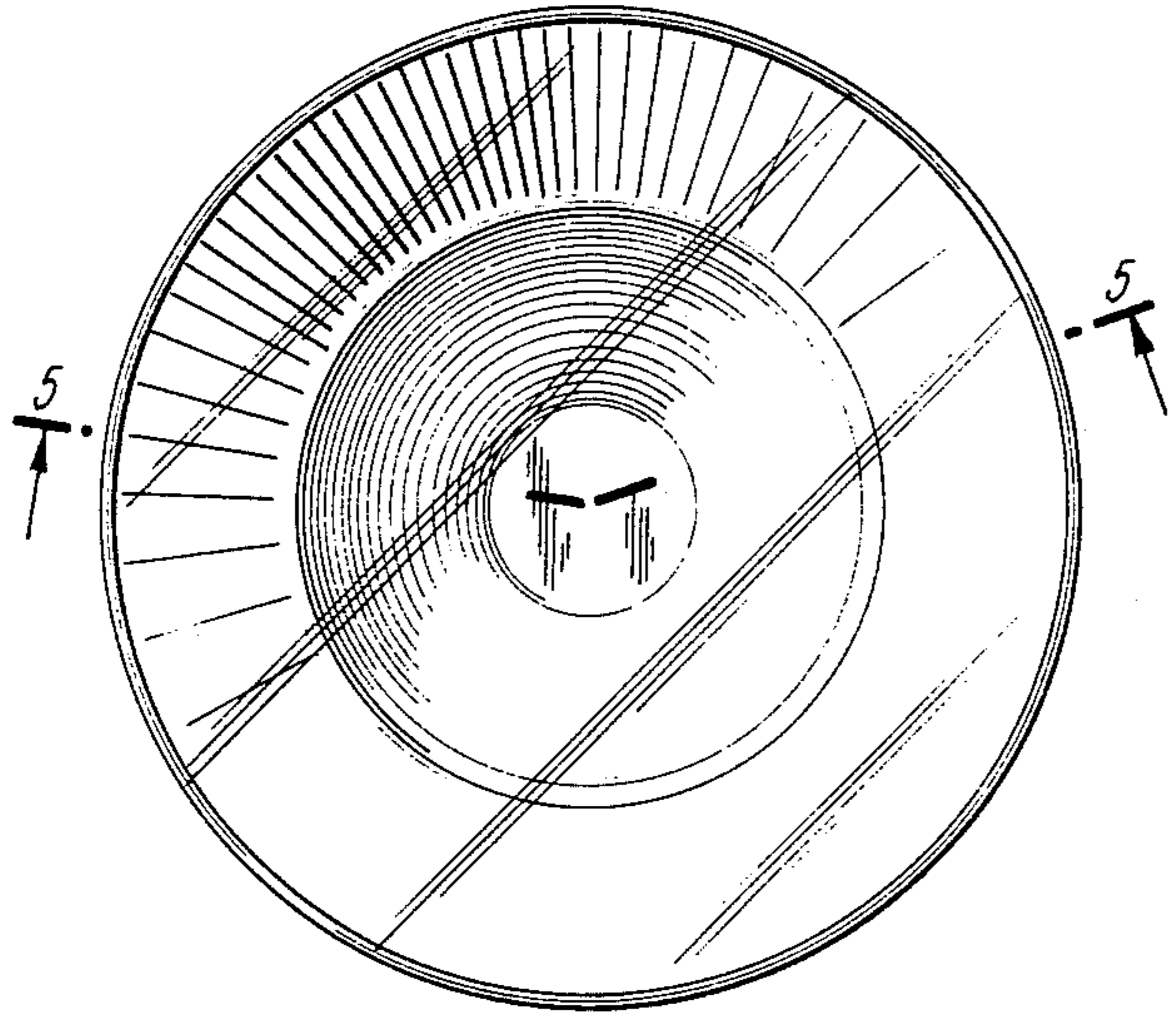

FIG. 5

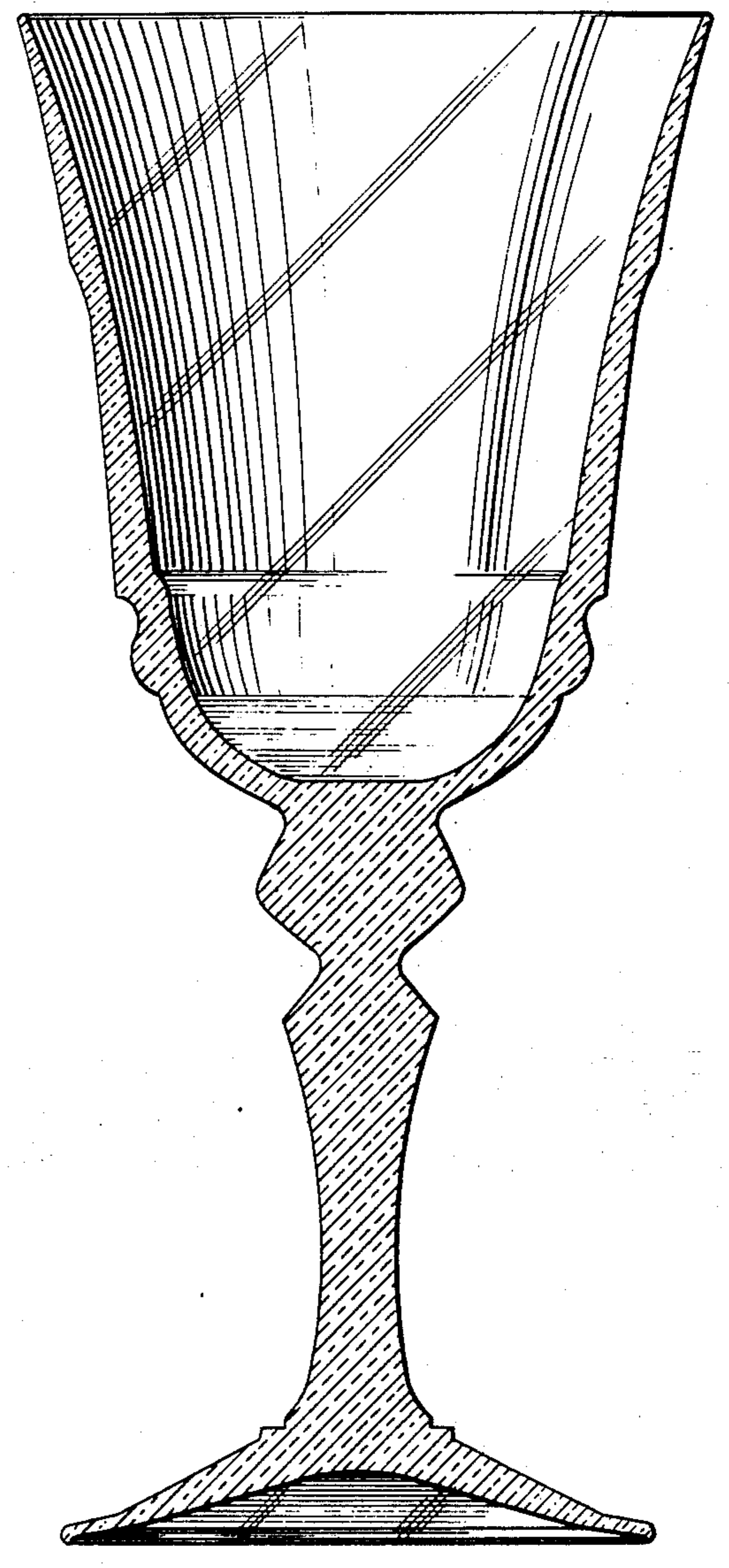

FIG. 4

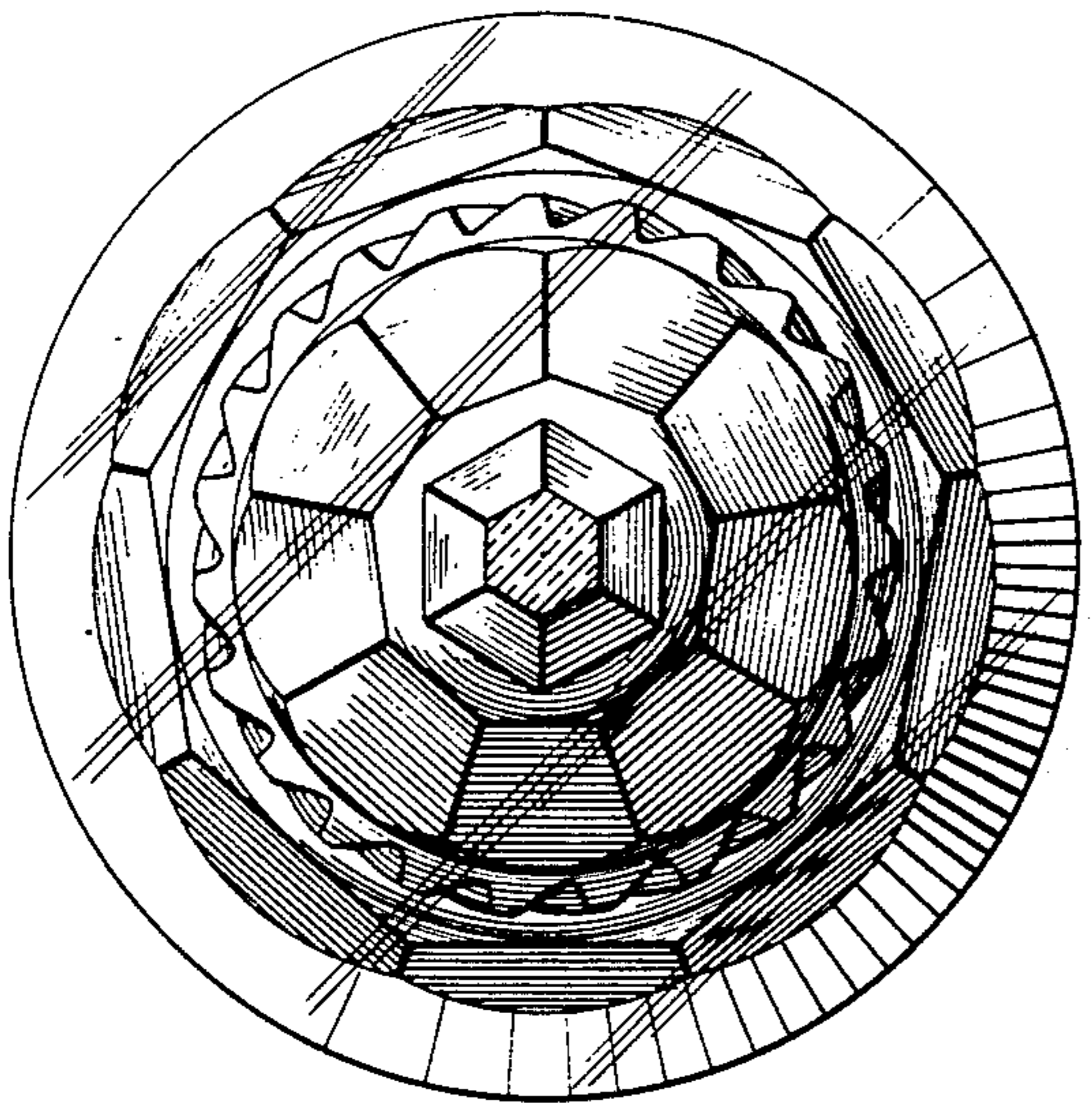

FIG. 6

