

[54] WHIRLPOOL BATHING SHELL

[75] Inventor: Robert C. Kingsley, Northridge, Calif.
[73] Assignee: Hydro-Spa Inc., Piru, Calif.
[**] Term: 14 Years
[21] Appl. No.: 663,770
[22] Filed: Oct. 23, 1984
[52] U.S. Cl. D24/38; D23/55
[58] Field of Search D24/38, 36; D23/55, D23/56, 49; 128/369, 66; 4/538, 546, 548, 552, 559, 560, 576, 580, 584, 566, 579, 488, 513, 568, 590

[56] References Cited
U.S. PATENT DOCUMENTS

D. 230,021	1/1974	Primault	D23/55
D. 251,920	5/1979	Ogden	D24/38
D. 254,206	2/1980	Ogden	D24/38
D. 255,932	7/1980	D'Innocente et al.	D23/55 X
3,736,924	6/1973	Jacuzzi et al.	D23/55 X

OTHER PUBLICATIONS

Sweets Catalog File-Products for General Building, ©1981, Whirlpool Bath Products, Section 15.7/RE, Regency Tub.

Primary Examiner—A. Hugo Word
Assistant Examiner—Stella M. Reid
Attorney, Agent, or Firm—Fulwider Patton Rieber Lee & Utecht

[57] CLAIM

The ornamental design for a whirlpool bathing shell, substantially as shown and described.

DESCRIPTION

FIG. 1 is a perspective view of a whirlpool bathing shell embodying my new design;
FIG. 2 is a top plan view thereof;
FIG. 3 is a right side elevational view thereof;
FIG. 4 is a rear side elevational view thereof;
FIG. 5 is a front elevational view thereof;
FIG. 6 is a left side elevational view thereof;
FIG. 7 is a bottom plan view thereof.
FIG. 8 is a sectional view taken on the line 8—8 of FIG. 2;
FIG. 9 is a fragmentary sectional view thereof, taken on the line 9—9 of FIG. 8;
FIG. 10 is a fragmentary sectional view thereof, taken on the line 10—10 of FIG. 8;
FIG. 11 is a perspective view of a second embodiment of the whirlpool bathing shell embodying my new design;
FIG. 12 is a perspective view of a third embodiment of the whirlpool bathing shell embodying my new design;
FIG. 13 is a top plan view of the third embodiment;
FIG. 14 is a right side elevational view of the third embodiment;
FIG. 15 is a rear elevational view of the third embodiment;
FIG. 16 is a front elevational view of the third embodiment;
FIG. 17 is a left side elevational view of the third embodiment;
FIG. 18 is a bottom plan view of the third embodiment.
FIG. 19 is a fragmentary sectional view of the third embodiment, taken on the line 19—19 of FIG. 13;
FIG. 20 is a fragmentary sectional view of the third embodiment, taken on the line 20—20 of FIG. 19;
FIG. 21 is a fragmentary sectional view of the third embodiment, taken on the line 21—21 of FIG. 19;
FIG. 22 is a perspective view of a fourth embodiment of the whirlpool bathing shell embodying my new design.

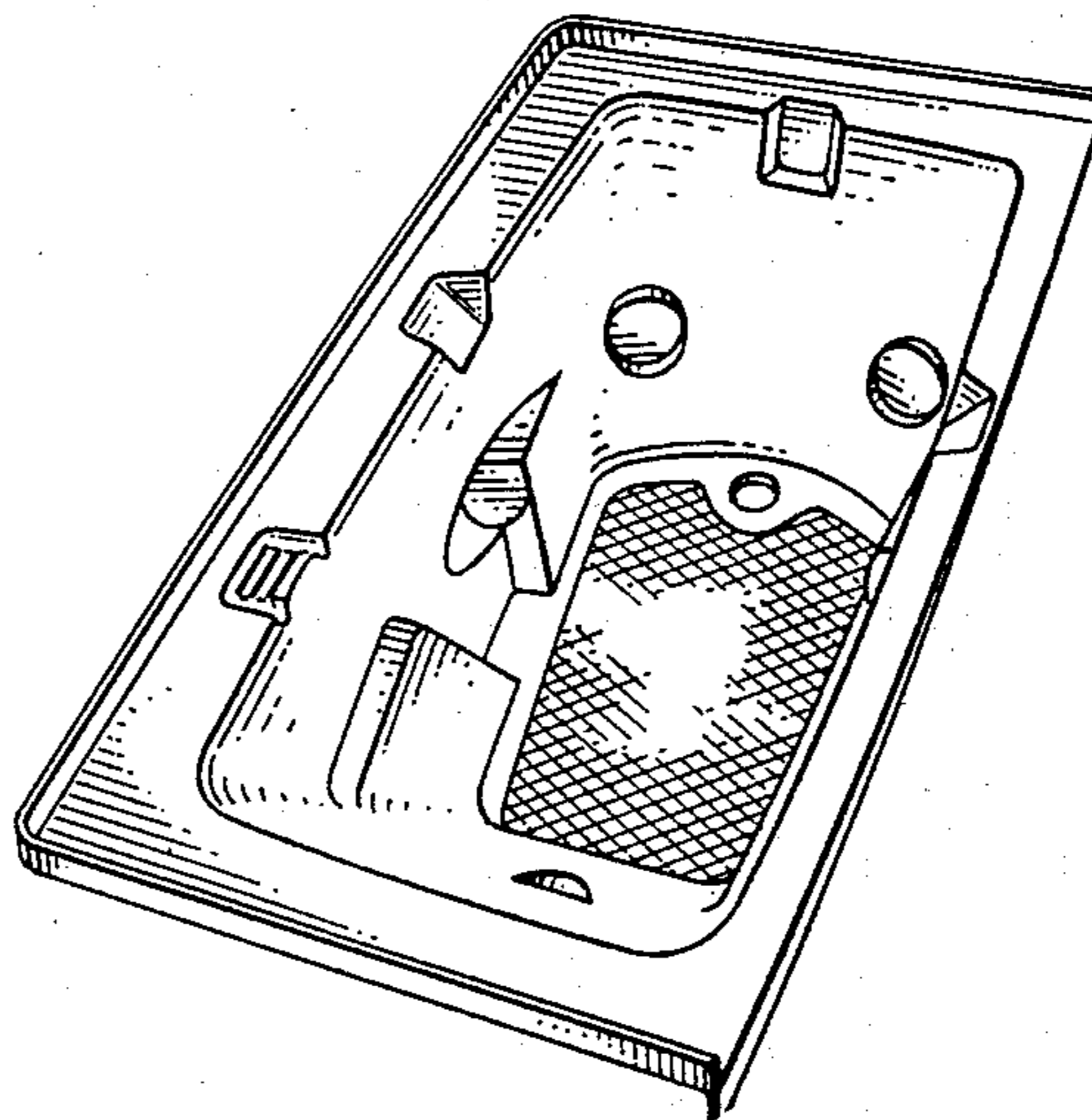

Fig. 1

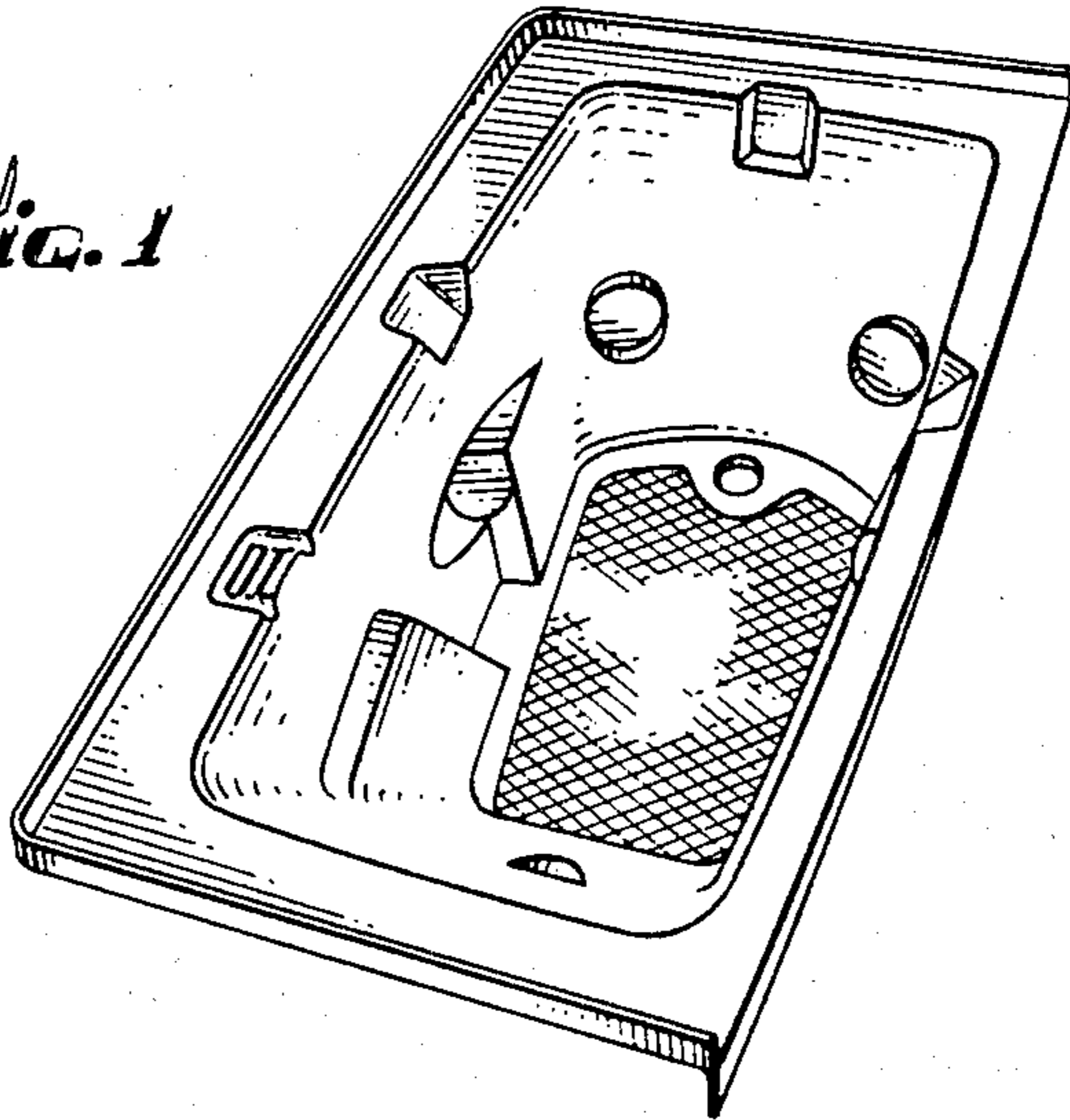

Fig. 2

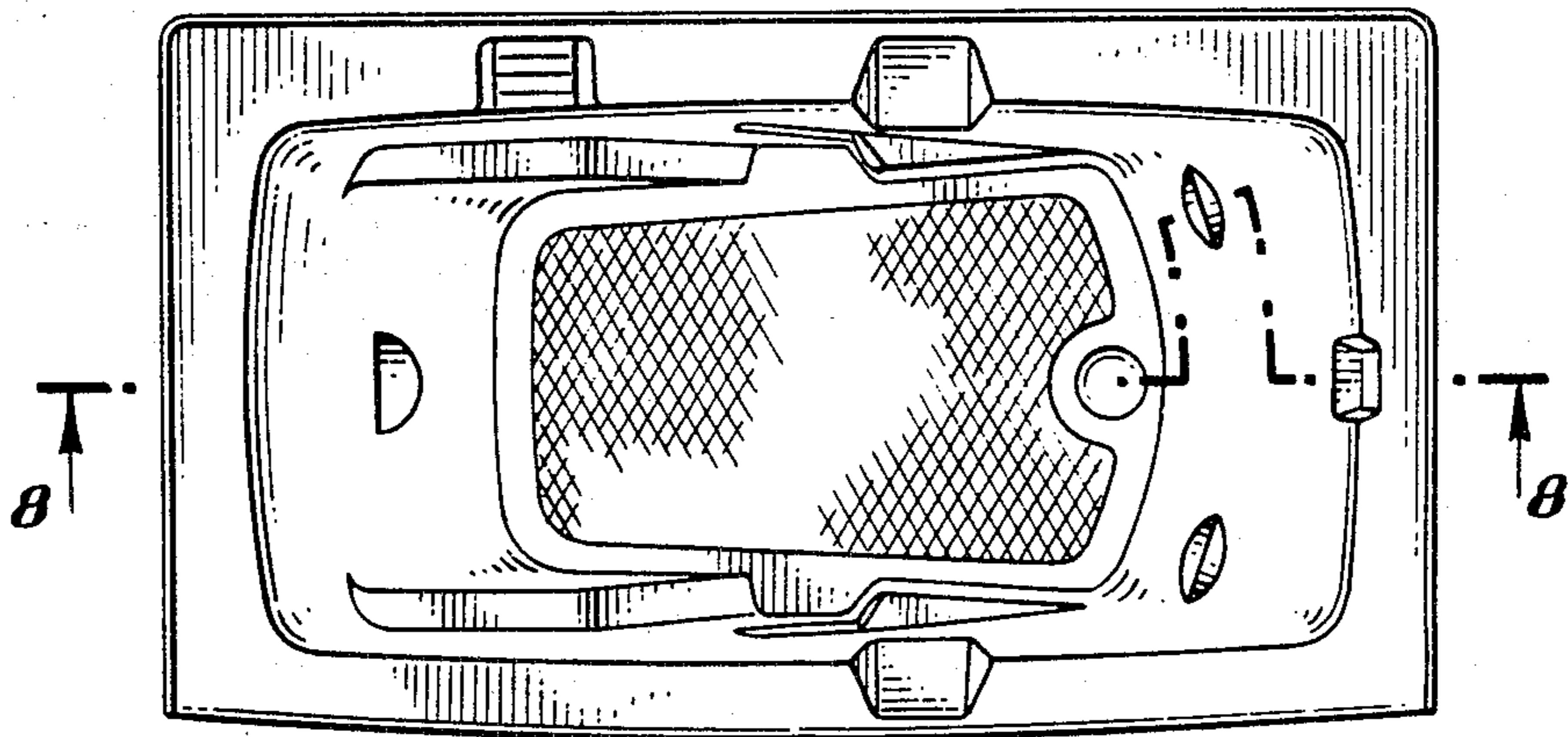

Fig. 3

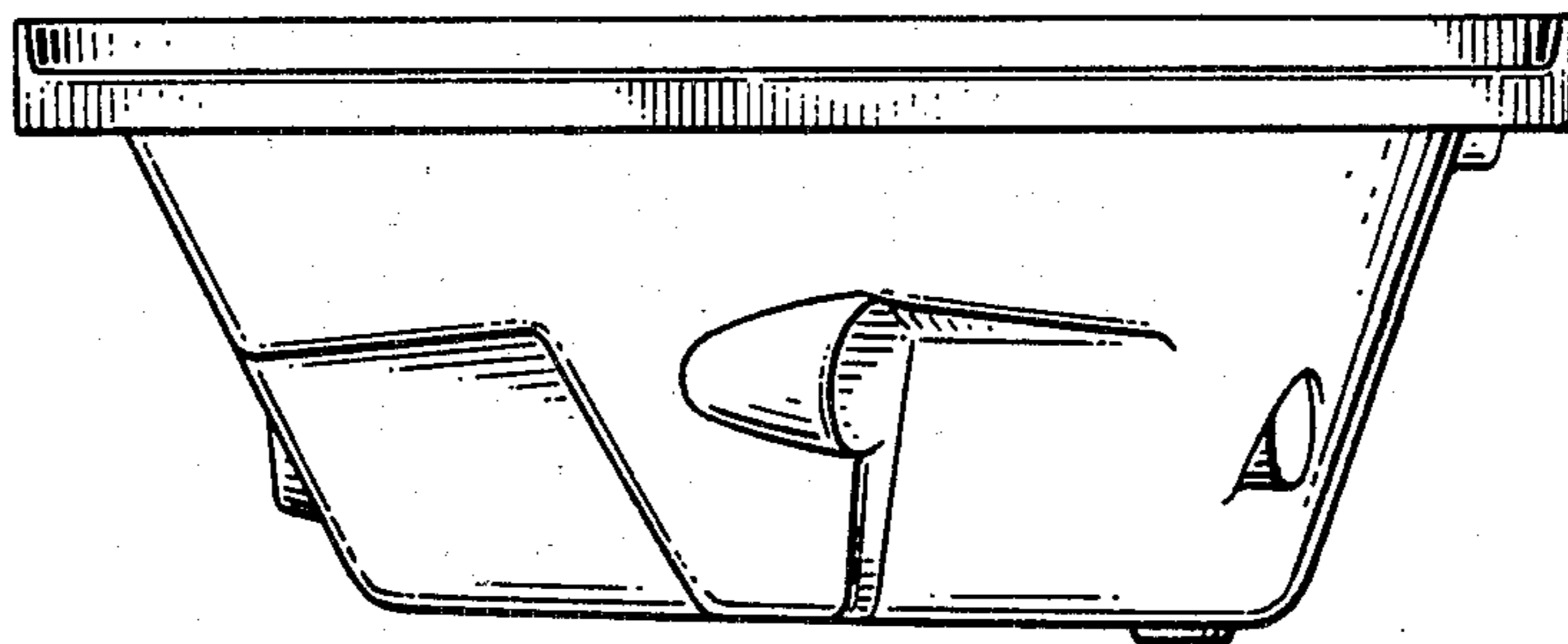

Fig. 4

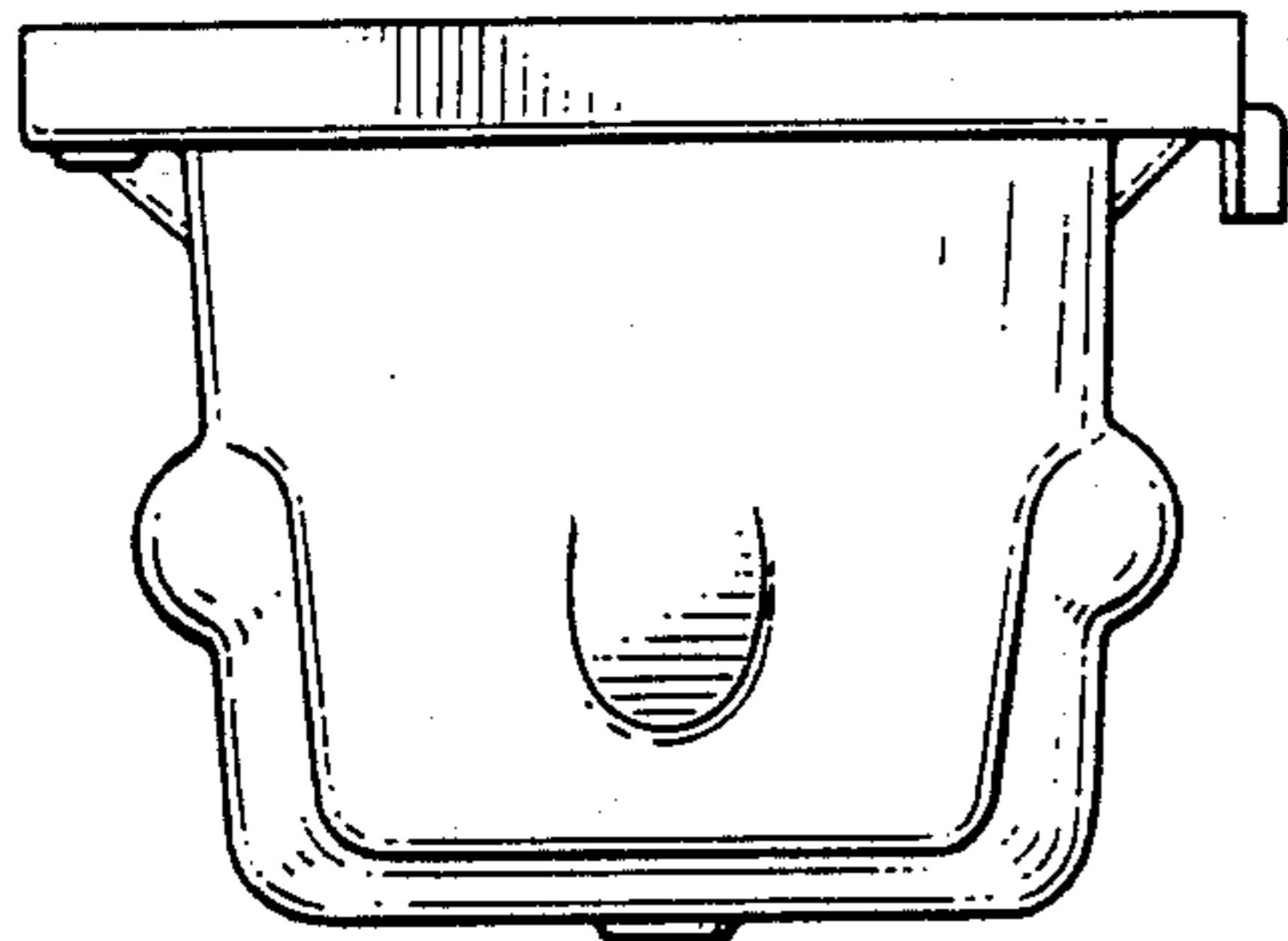

Fig. 5

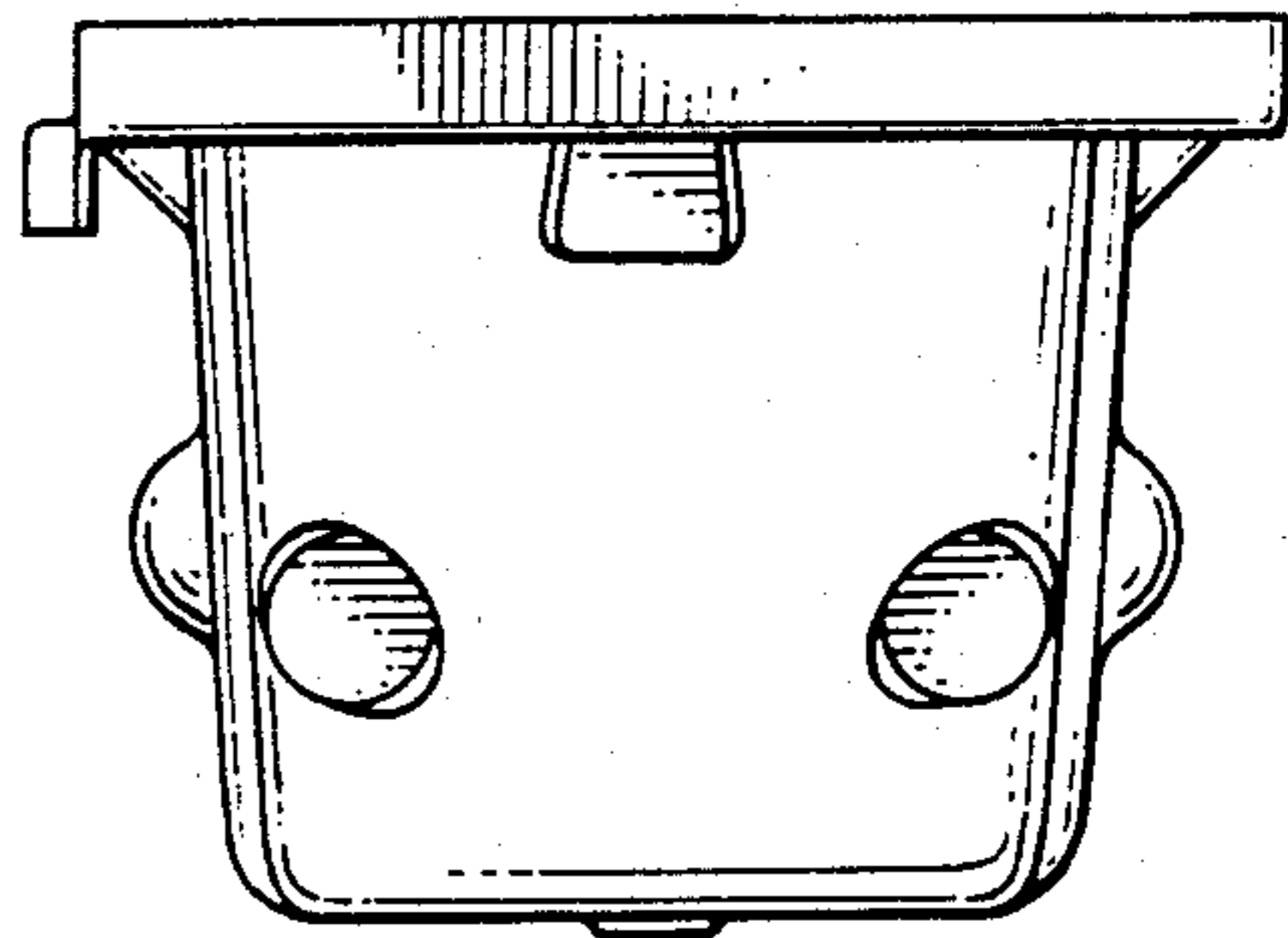

Fig. 6

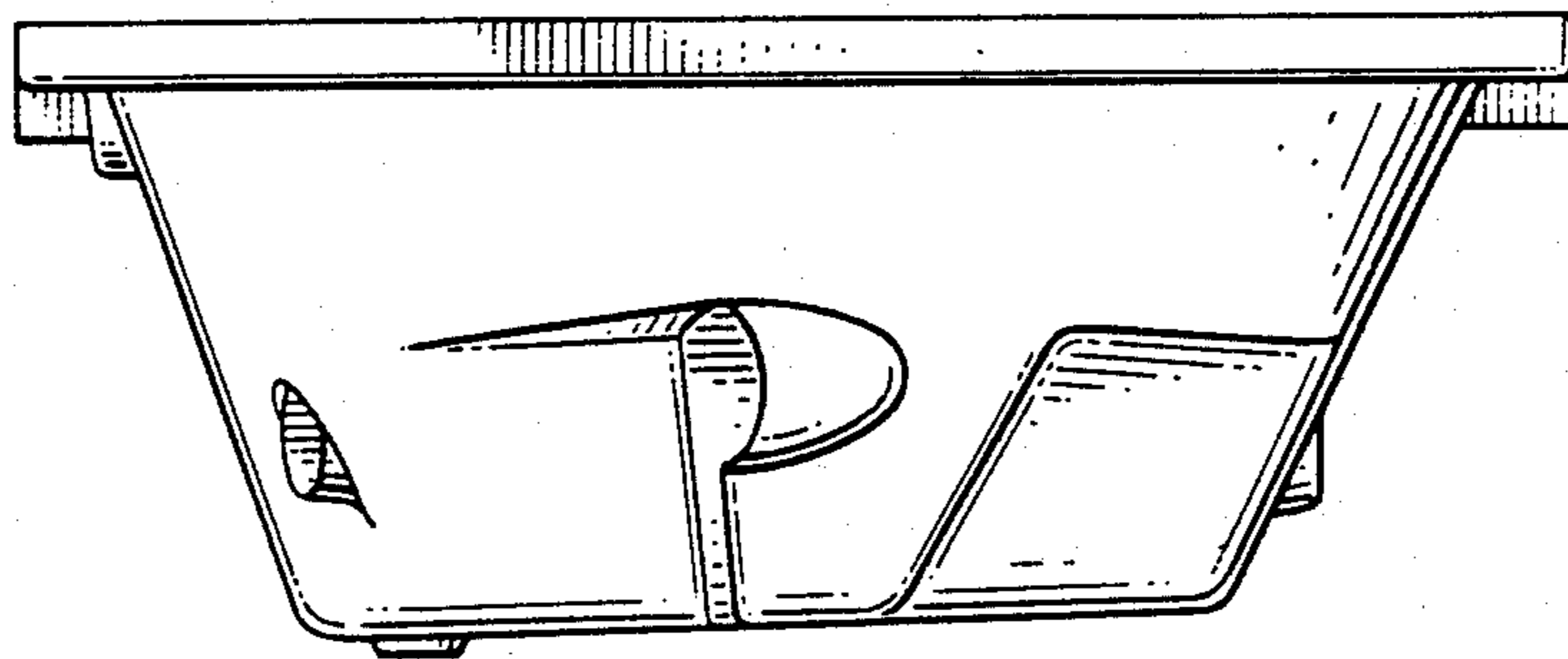

Fig. 7

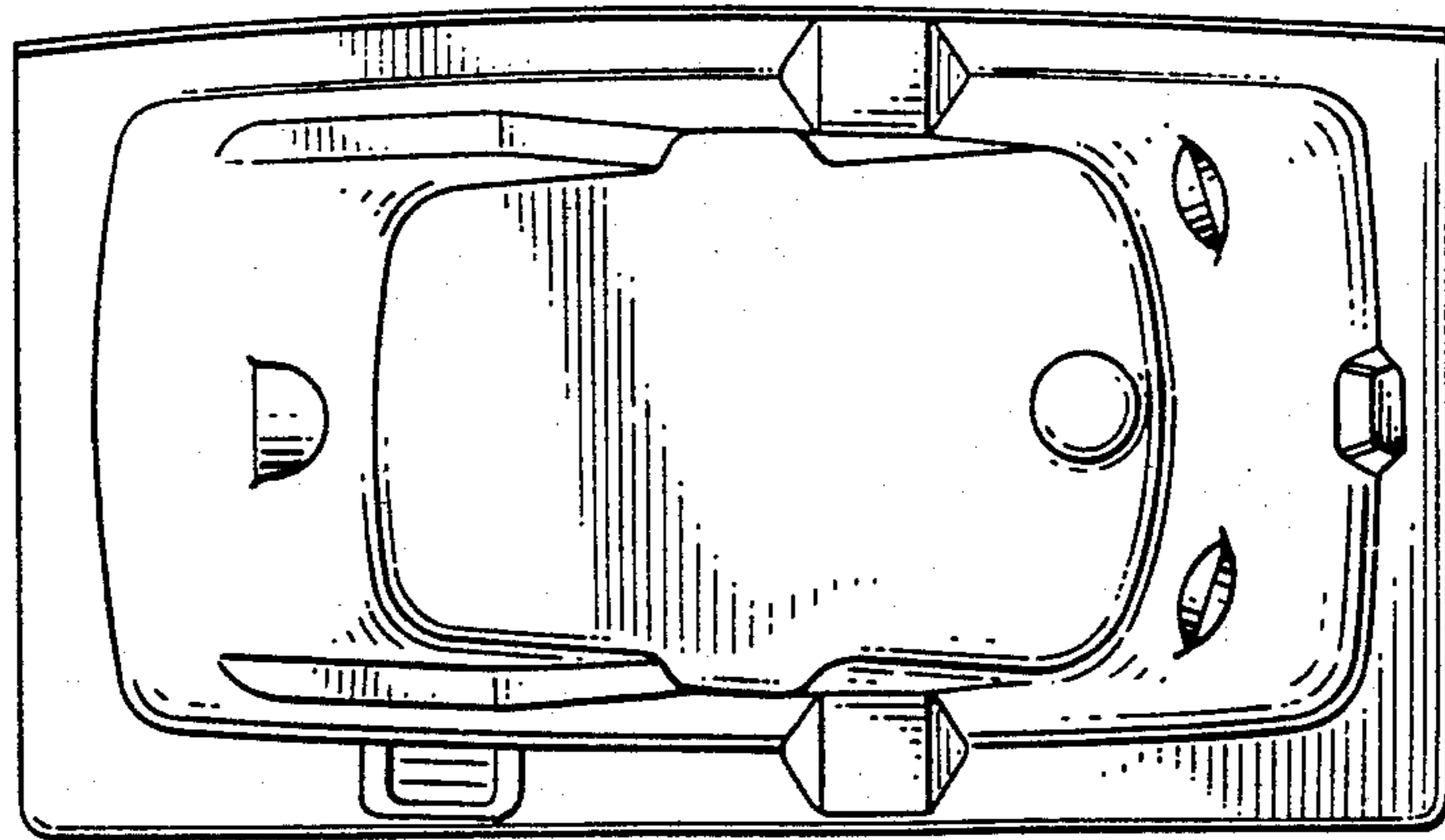

Fig. 8

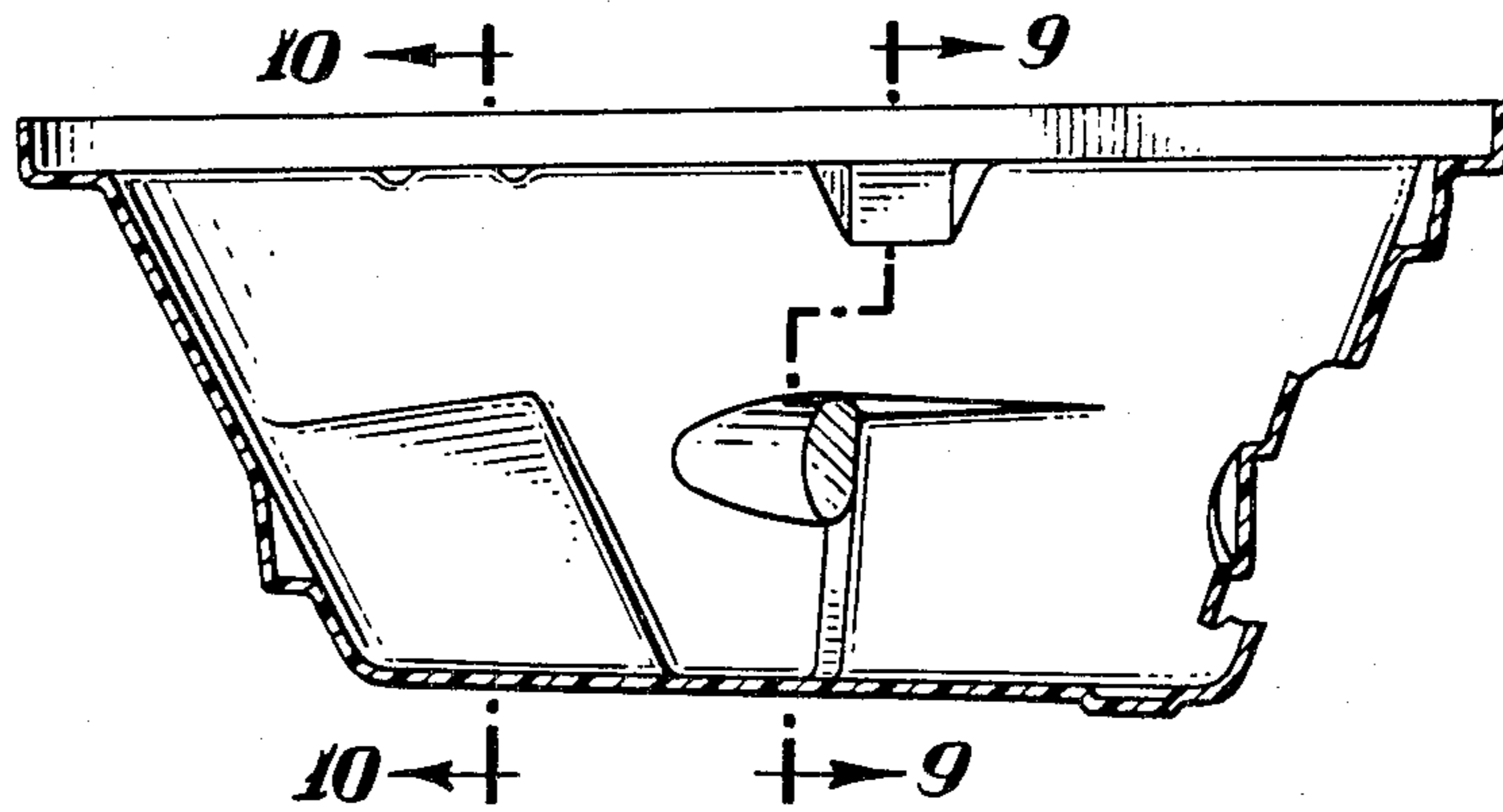

Fig. 9

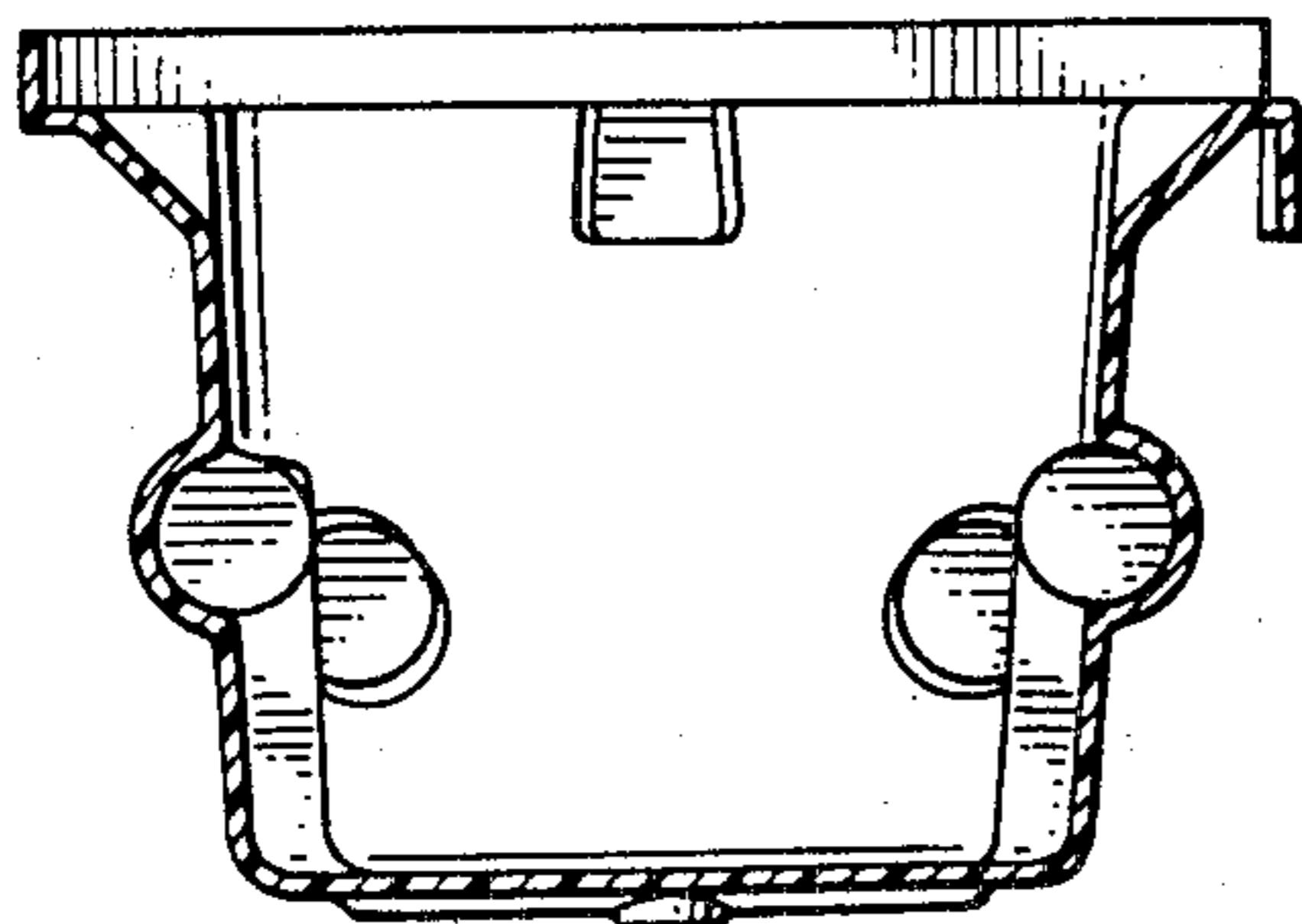

Fig. 10

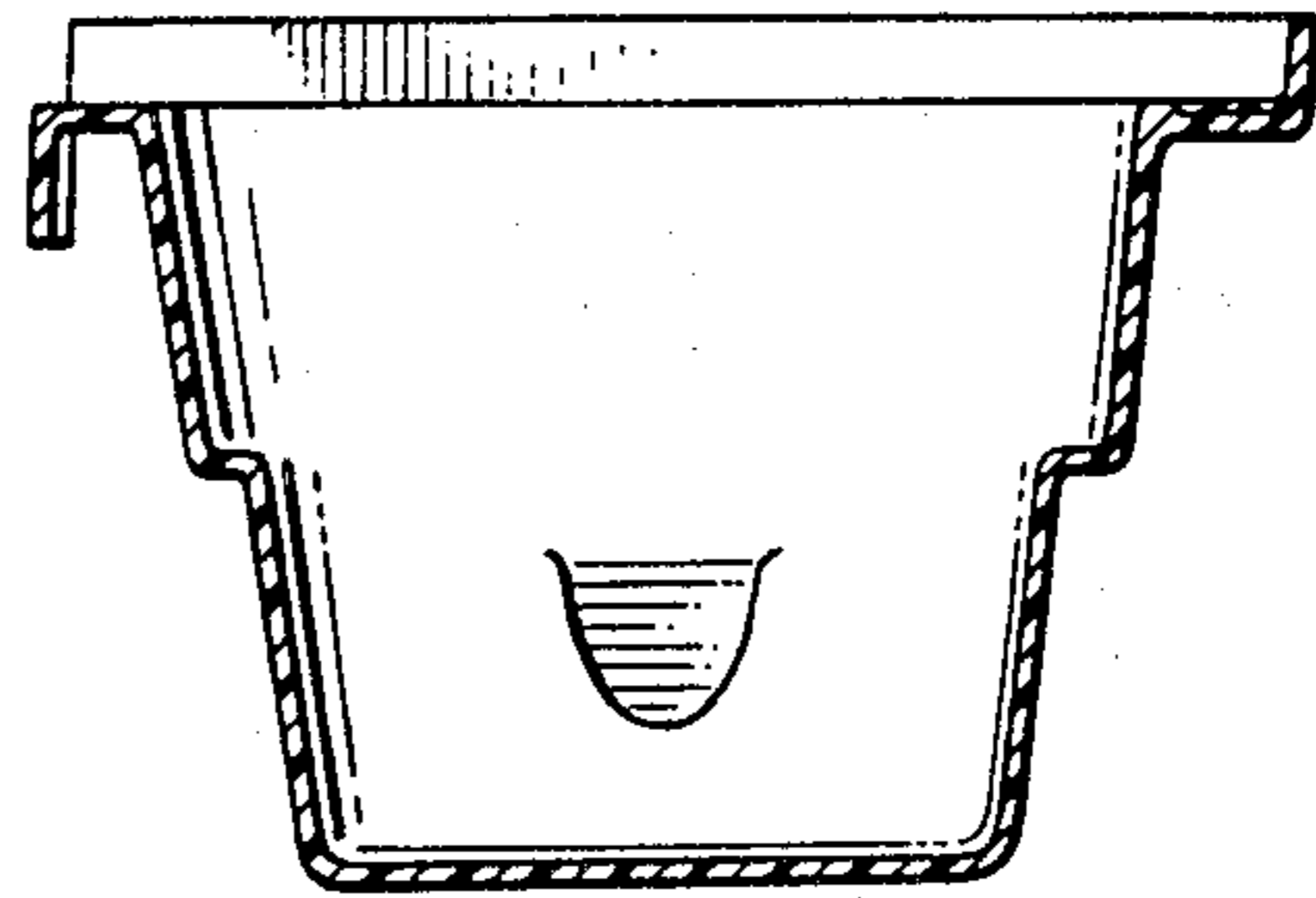
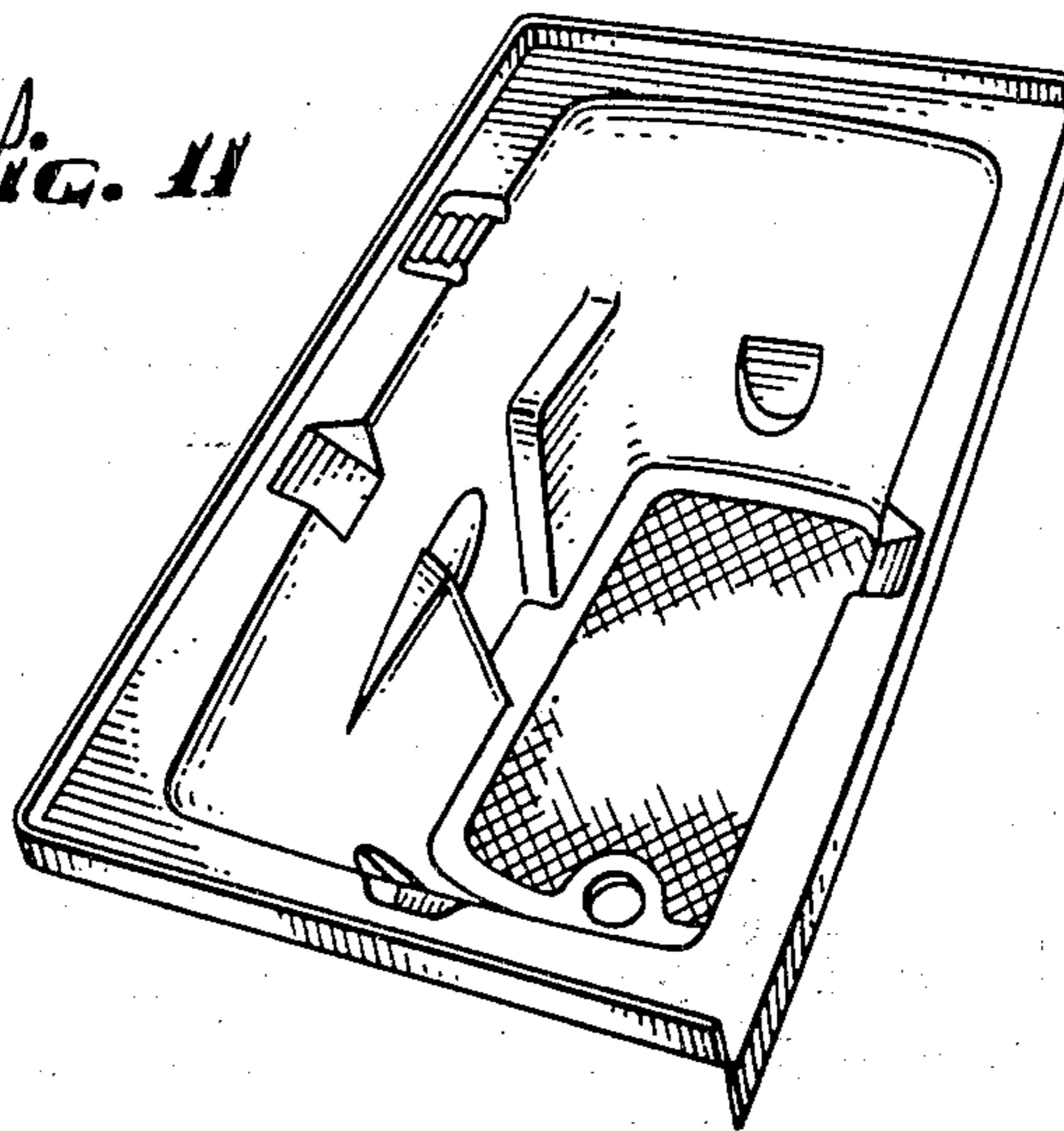

Fig. 11



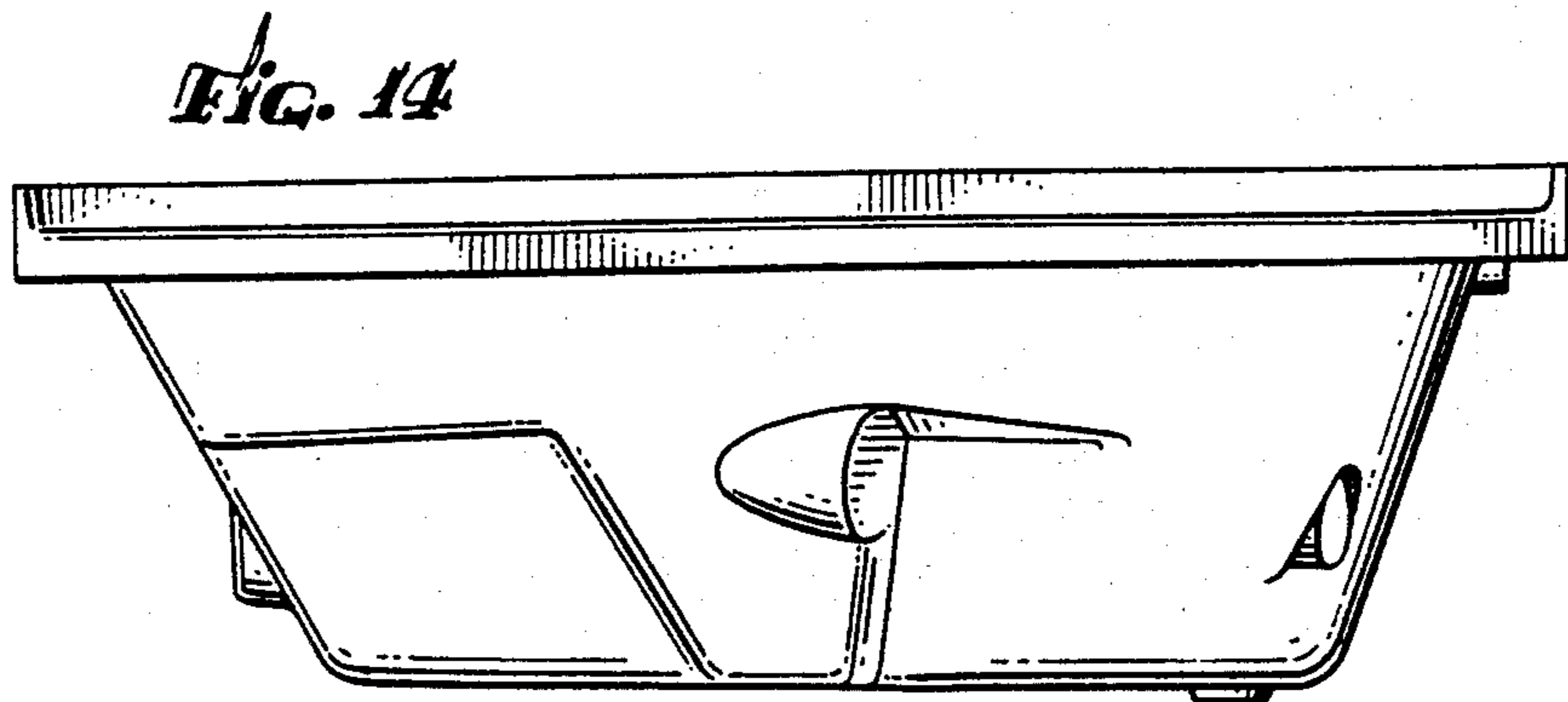
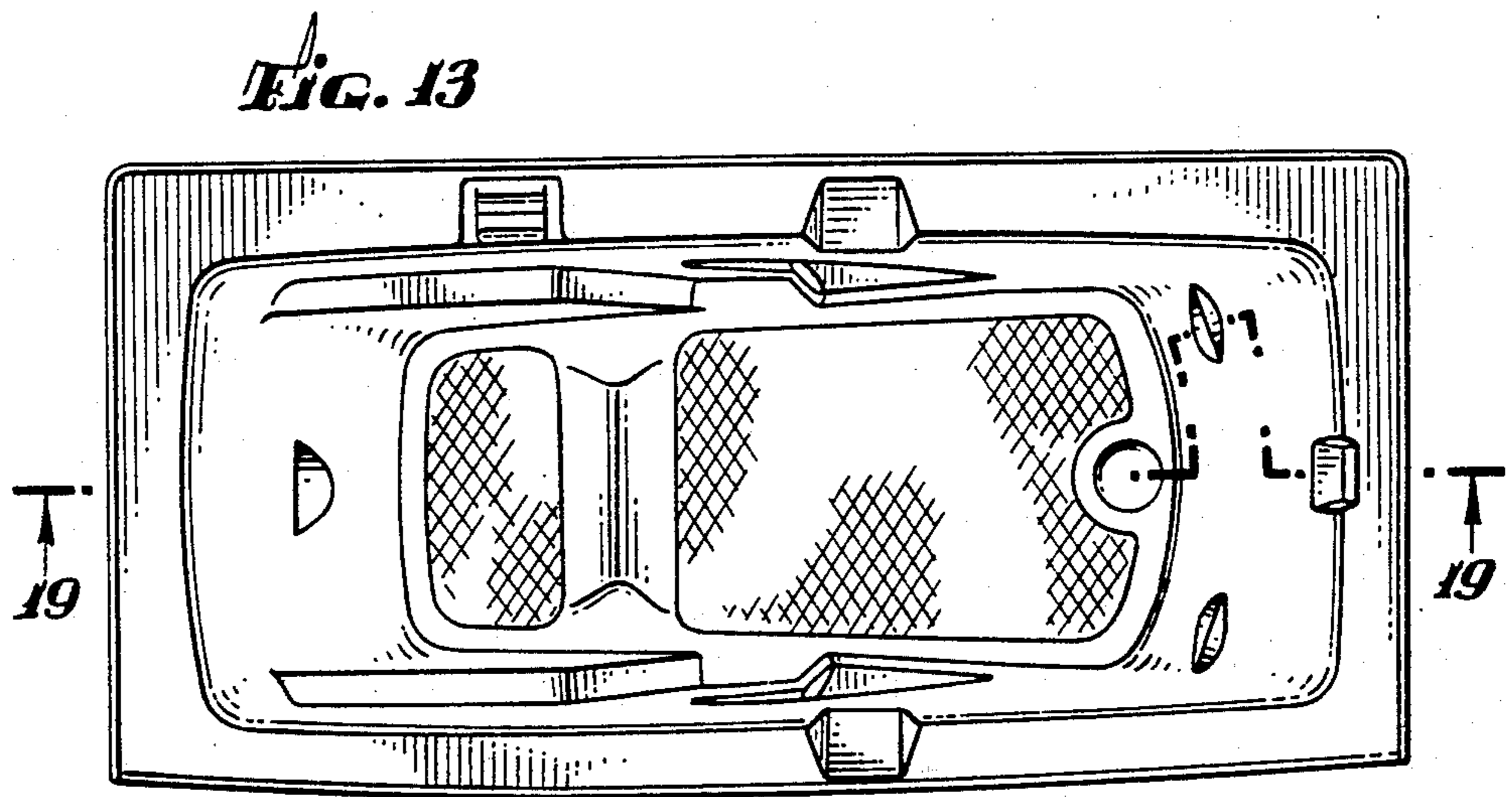
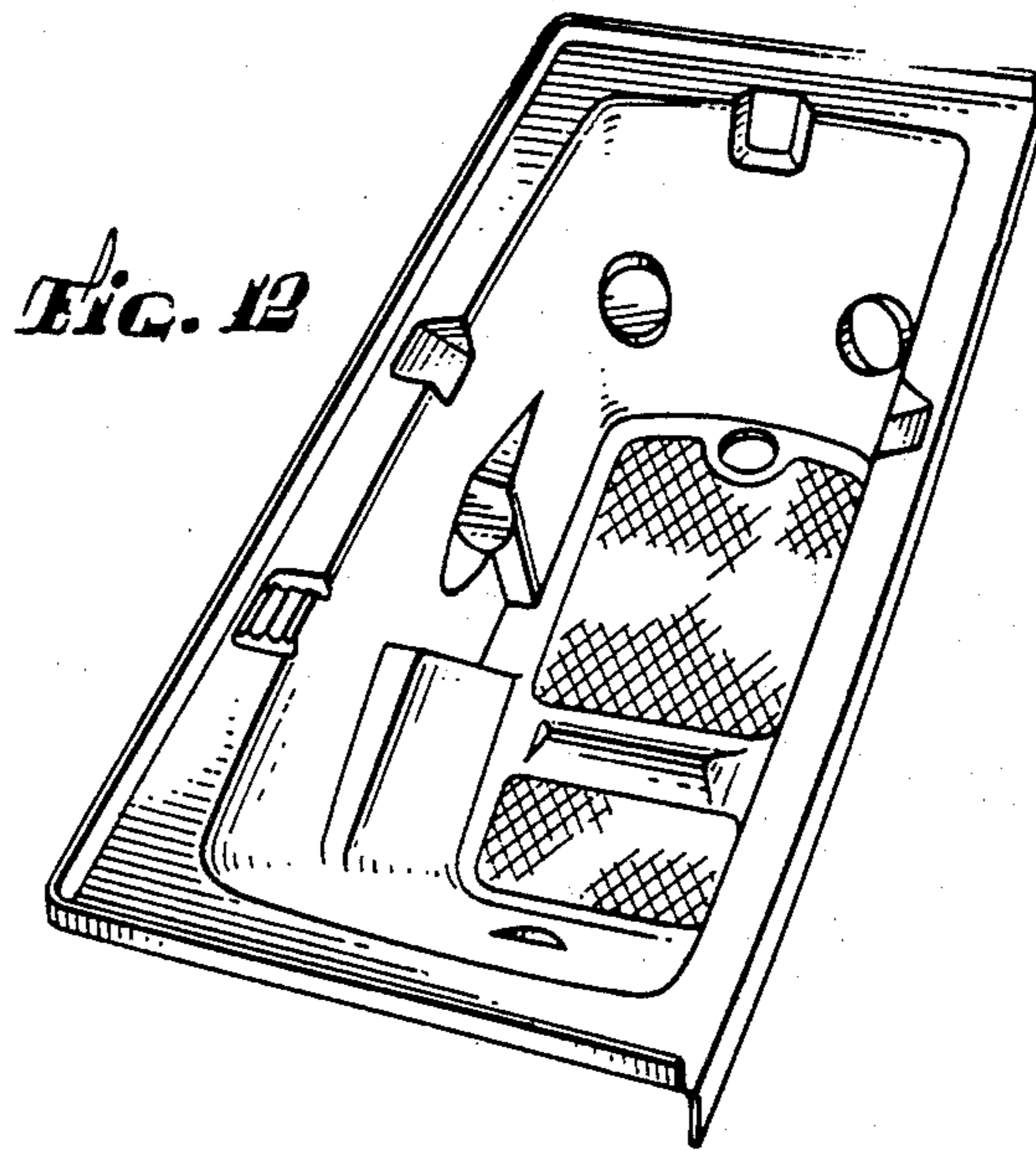

FIG. 15

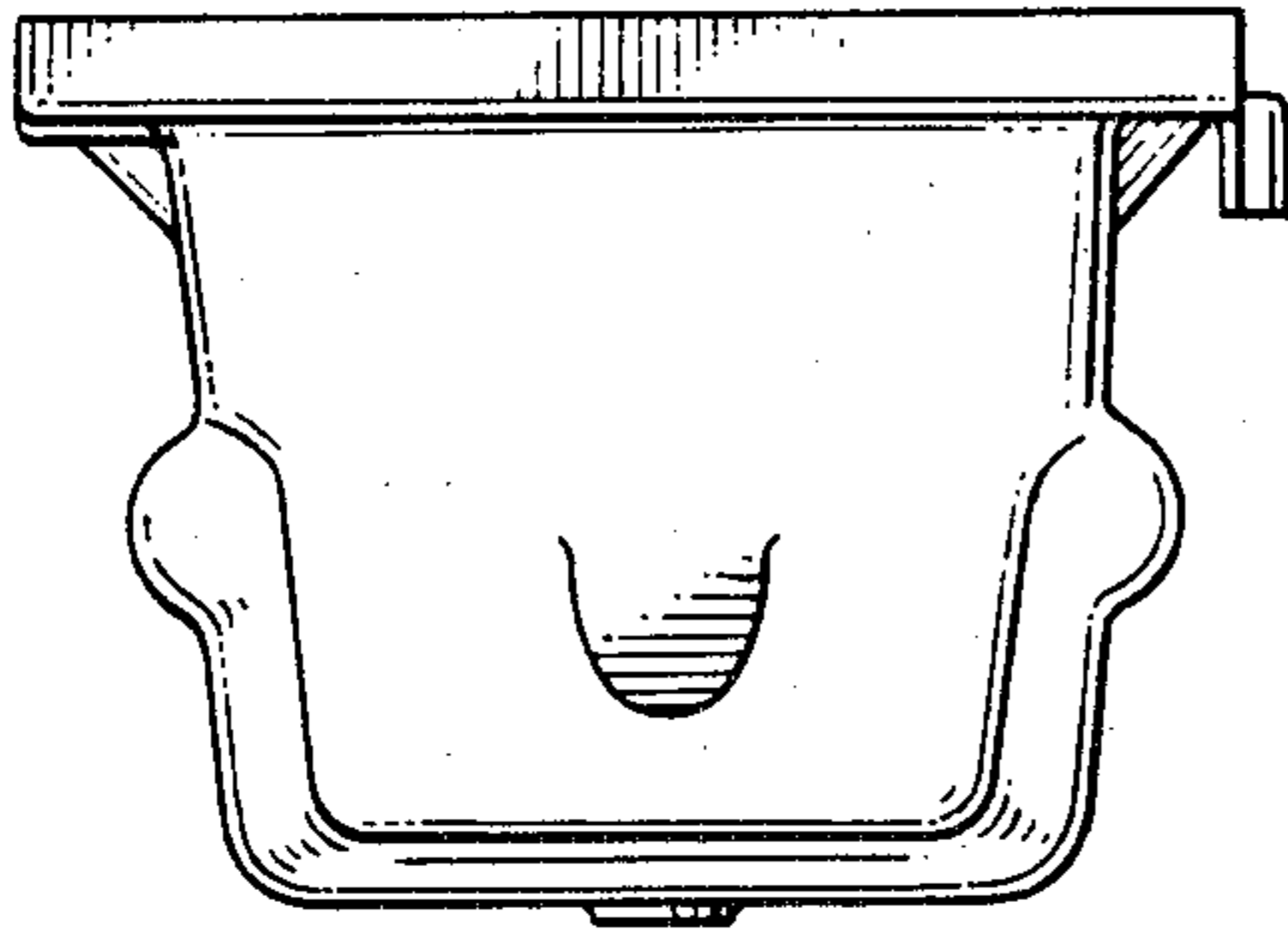

FIG. 16

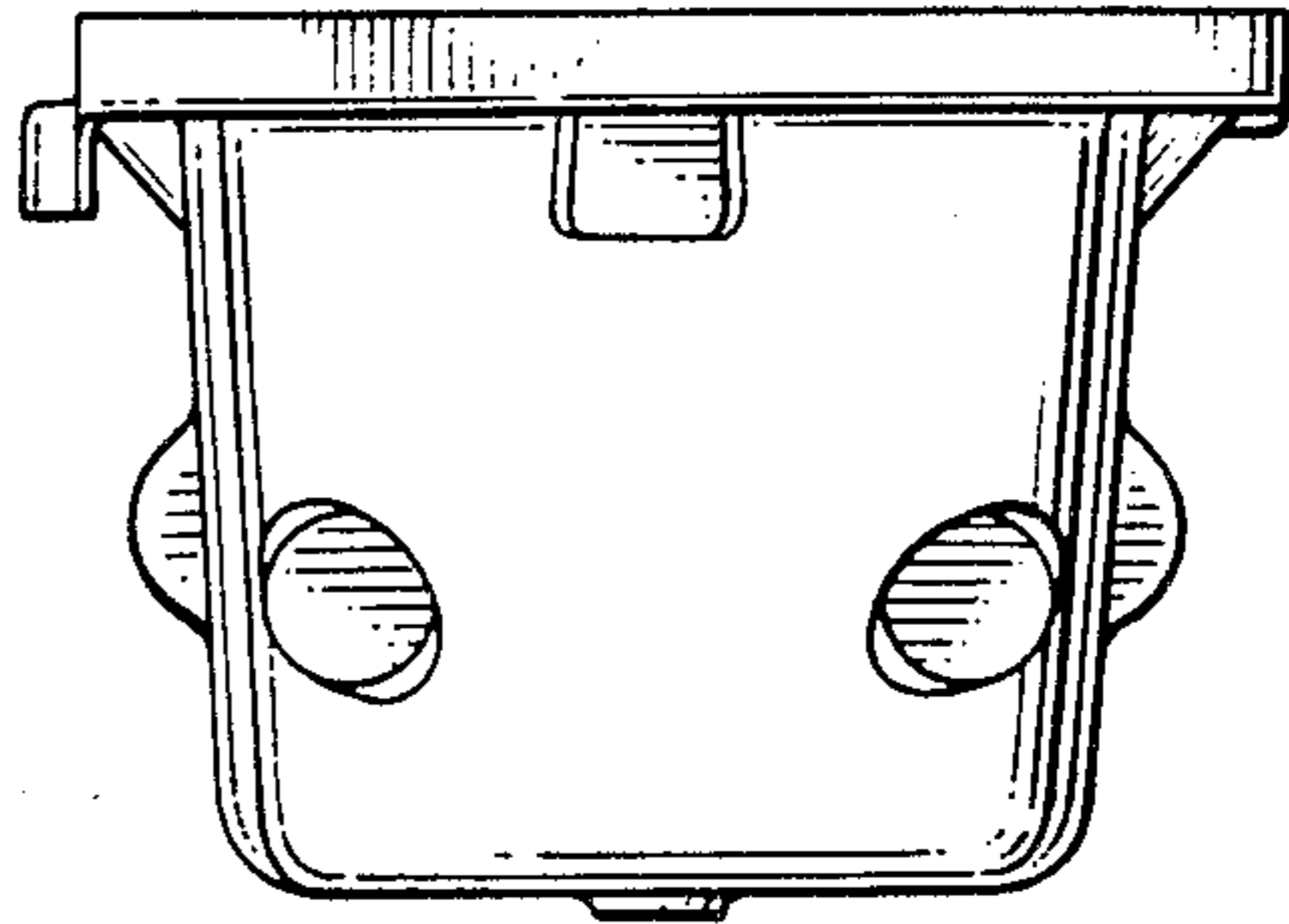

FIG. 17

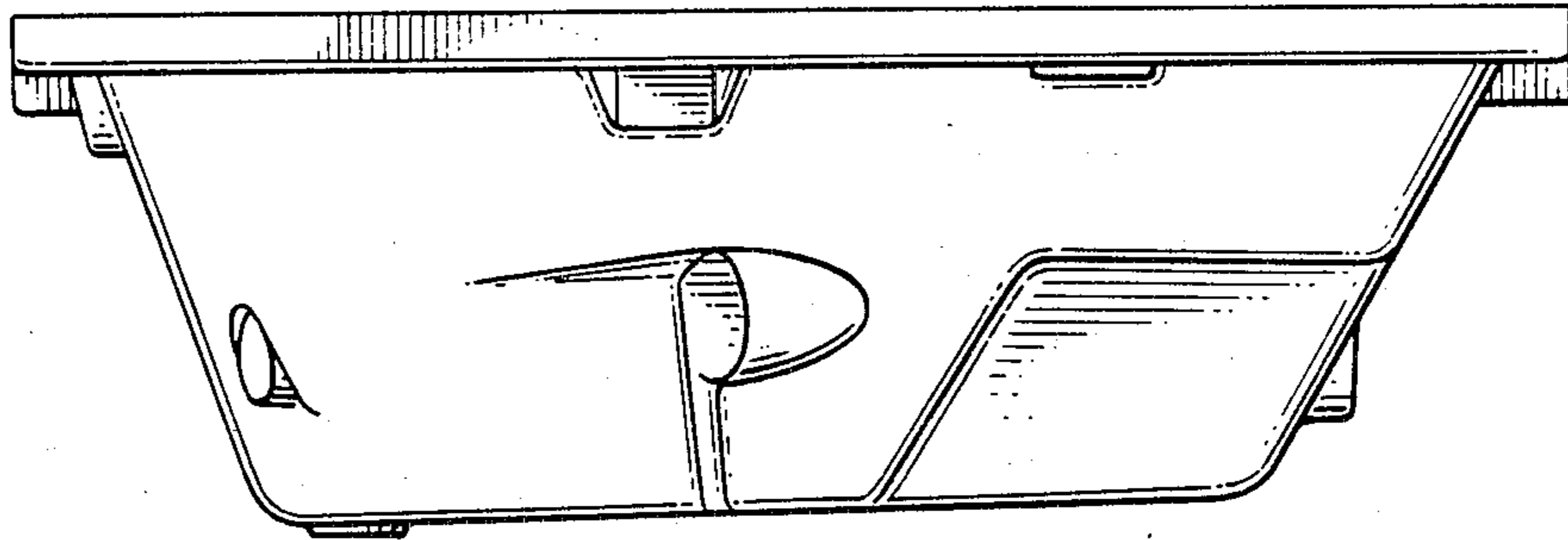

FIG. 18

