

[54] CORDLESS TELEPHONE BASE

[75] Inventor: Stephen A. Nichols, Indianapolis, Ind.

[73] Assignee: Uniden Corporation of America, Indianapolis, Ind.

[**] Term: 14 Years

[21] Appl. No.: 473,652

[22] Filed: Mar. 9, 1983

[52] U.S. Cl. D14/60; D14/68; D14/71; D14/30; D14/52

[58] Field of Search D14/53, 58, 60, 63, D14/100; 179/179, 100 C, 100 R, 100 L, 101, 103, 2 EA, 1; D18/6, 7, 8, 11

[56] References Cited

U.S. PATENT DOCUMENTS

D. 190,145	4/1961	Reed et al.	D18/12
D. 209,910	1/1968	Tyson	D14/63
D. 218,612	9/1970	Payne	D14/62
D. 224,021	6/1972	Mika et al.	D14/100
D. 229,564	12/1973	Chadima, Jr.	D14/100
D. 260,886	9/1981	Taylor	D14/100
D. 265,734	8/1982	Mahan	D4/53
3,521,008	7/1970	Tyson	D14/64
4,349,706	9/1982	Thompson	179/146 R

OTHER PUBLICATIONS

Best Products 1982/1983 catalog; at p. 303, "Extend-A-Phone" Cordless Models Ex-4000 & Ex-3000. Montgomery Ward, Spring & Summer '83 catalog; at p. 312; Uniden's Model "Extend-A-Phone" 3000.

AT&T "Nomad" 400 Cordless Telephone; 5 page brochure.

Uniden Corp. of America Price List 6-1-82, 4 page Pocket Booklet showing Extend-A-Phone Models Ex 3000, 4000, 5000 et seq.

W. Bello Co. 1982 catalog ©1981; "Cobra" Cordless Telephone, item V, p. 239; Model 501 21C.

Primary Examiner—Wallace R. Burke

Assistant Examiner—Horace B. Fay

Attorney, Agent, or Firm—Banner, Birch, McKie & Beckett

[57] CLAIM

The ornamental design for a cordless telephone base, as shown and described.

DESCRIPTION

FIG. 1 is a top plan view of a cordless telephone base showing my new design;

FIG. 2 is a bottom plan view thereof;

FIG. 3 is a right side elevational view thereof;

FIG. 4 is a left side elevational view thereof;

FIG. 5 is a front elevational view thereof;

FIG. 6 is a rear elevational view thereof; and

FIG. 7 is a top plan view of a second embodiment thereof, the remaining views of which are substantially the same as corresponding views of the FIG. 1 embodiment.

FIG. 8 is a perspective view from above of the first embodiment showing the front, top and right side of the base unit; and

FIG. 9 is a perspective view from above of the first embodiment showing the rear, top and left side.

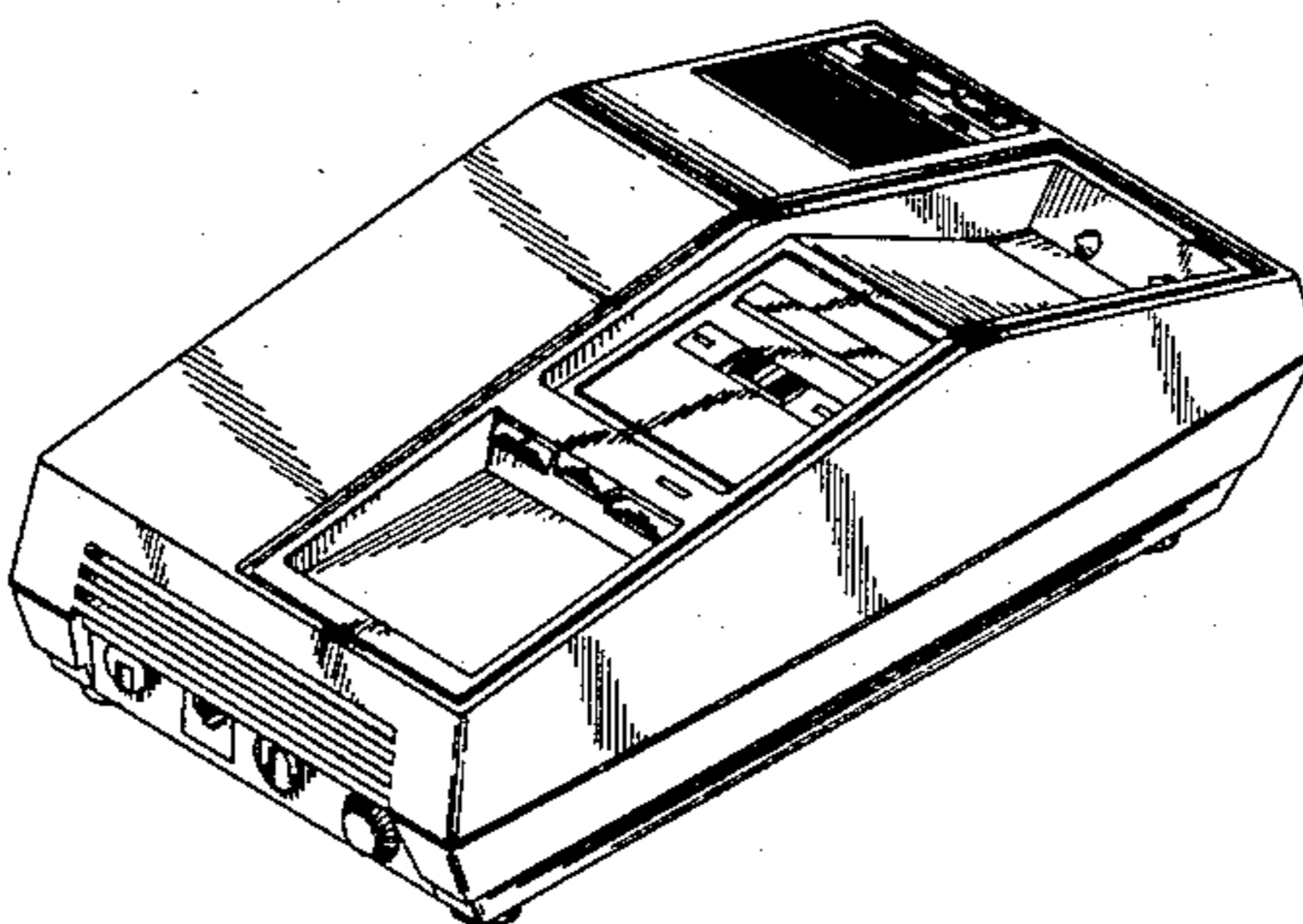
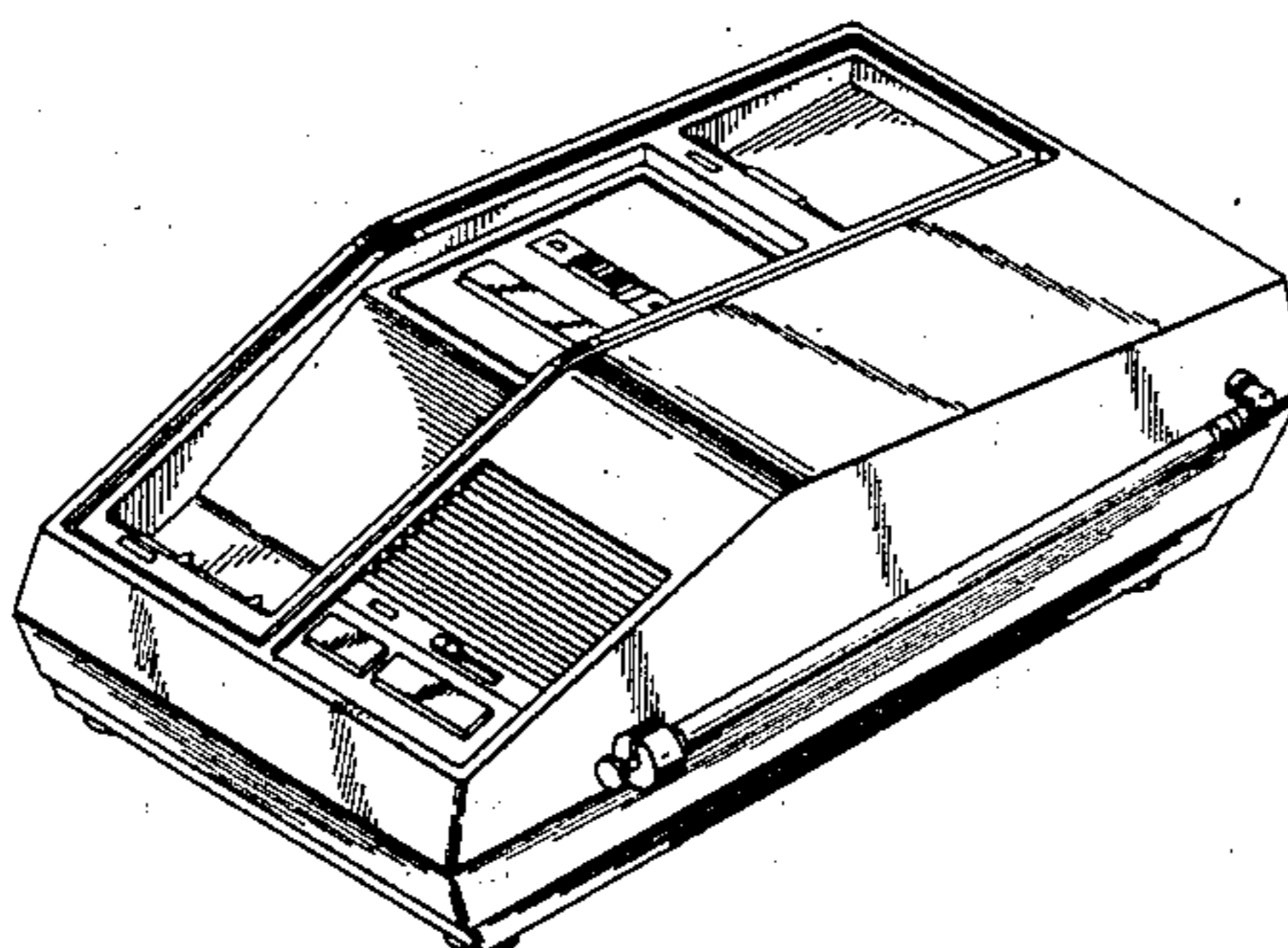

FIG. 1.

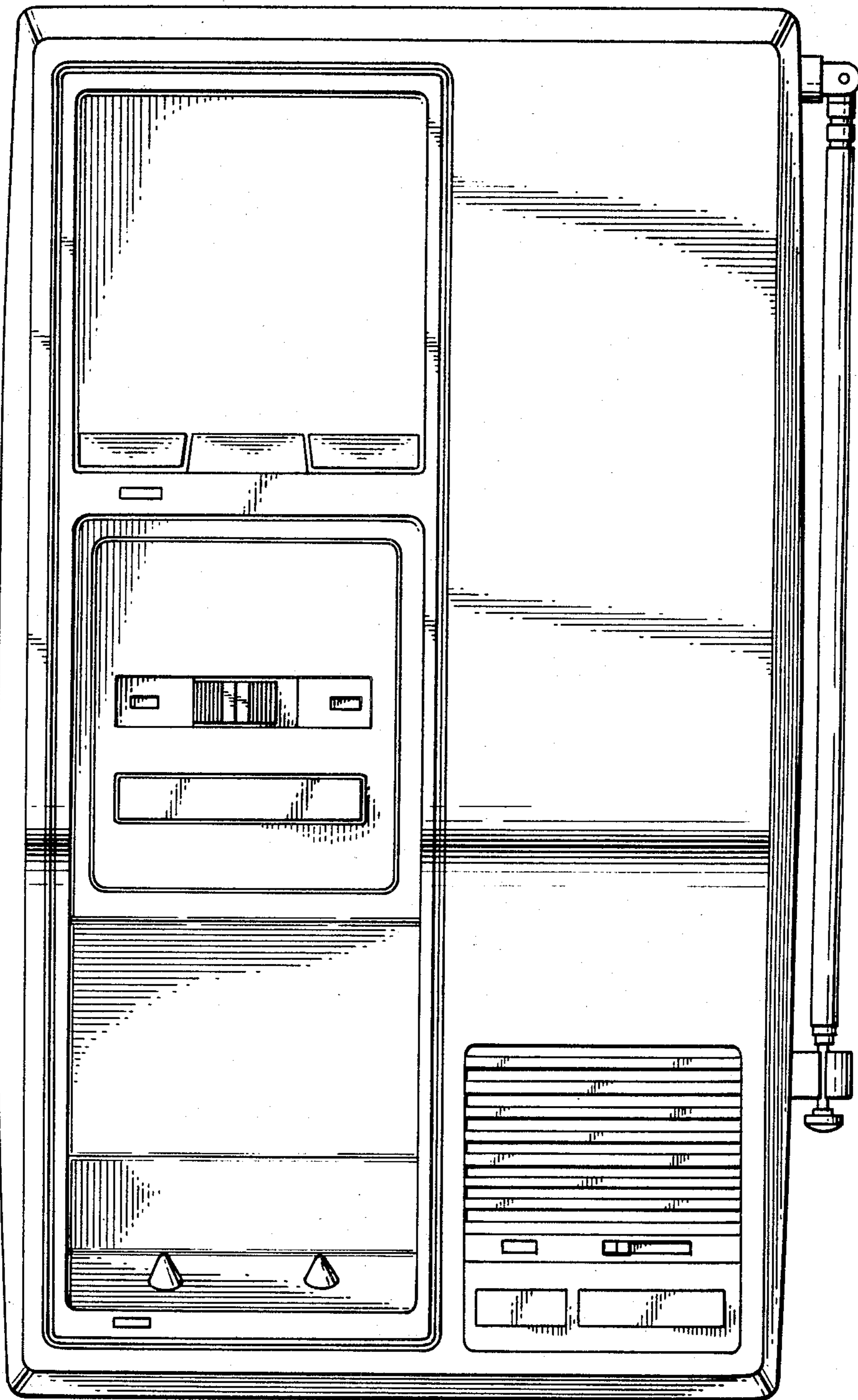
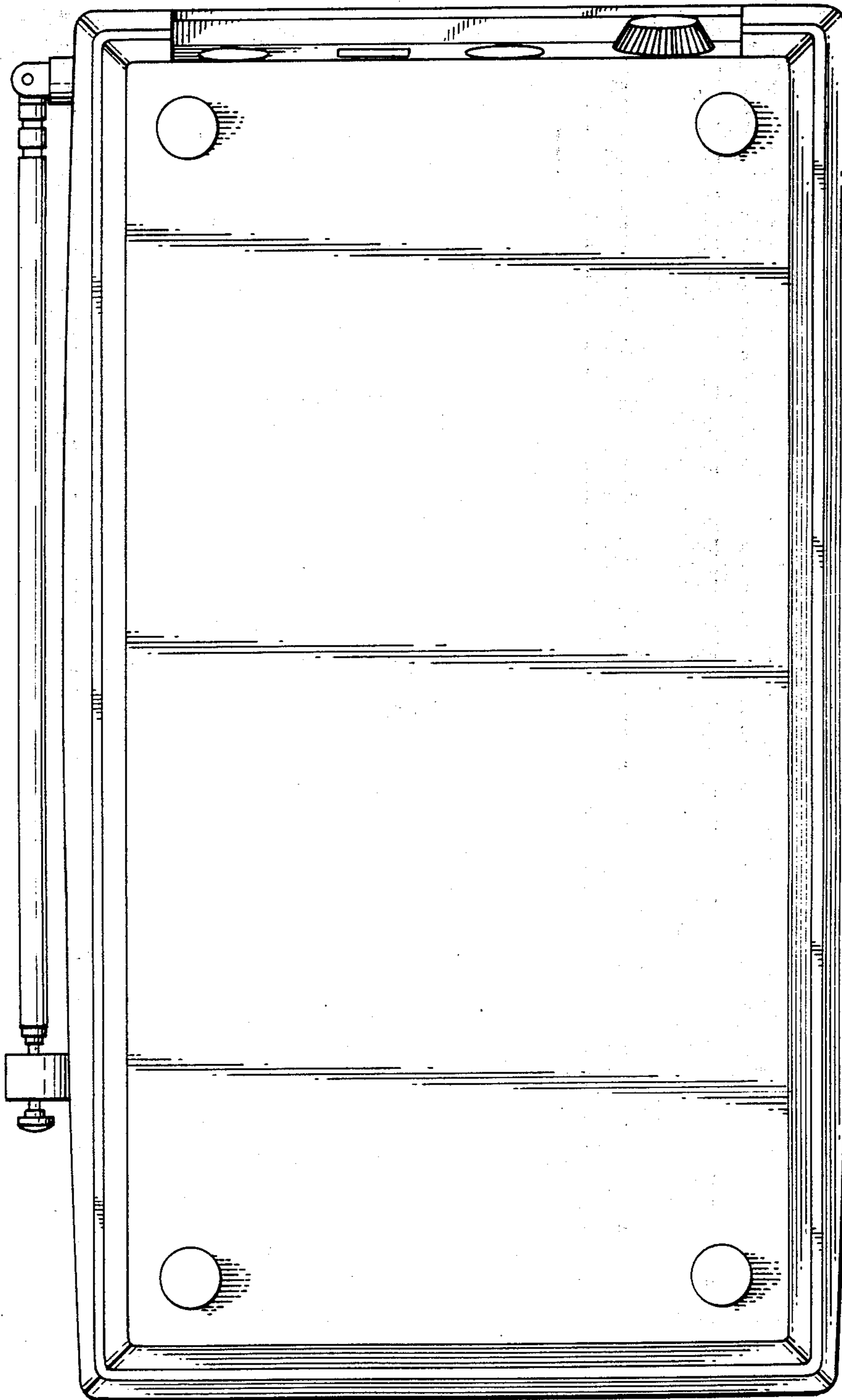

FIG. 2.



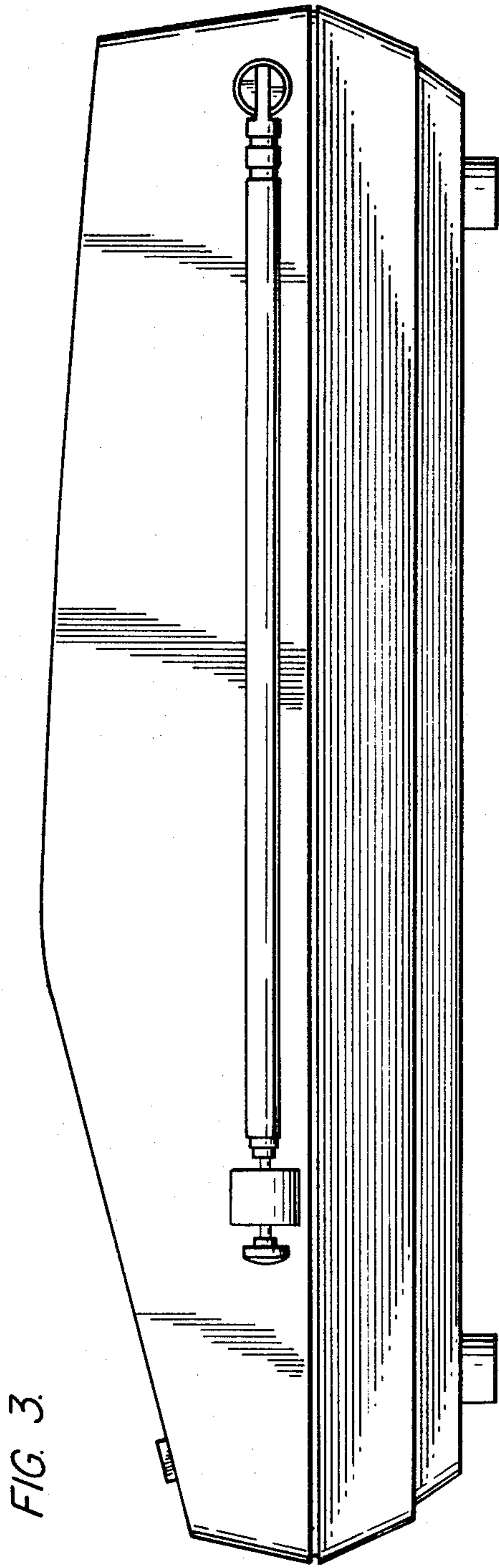

FIG. 4.

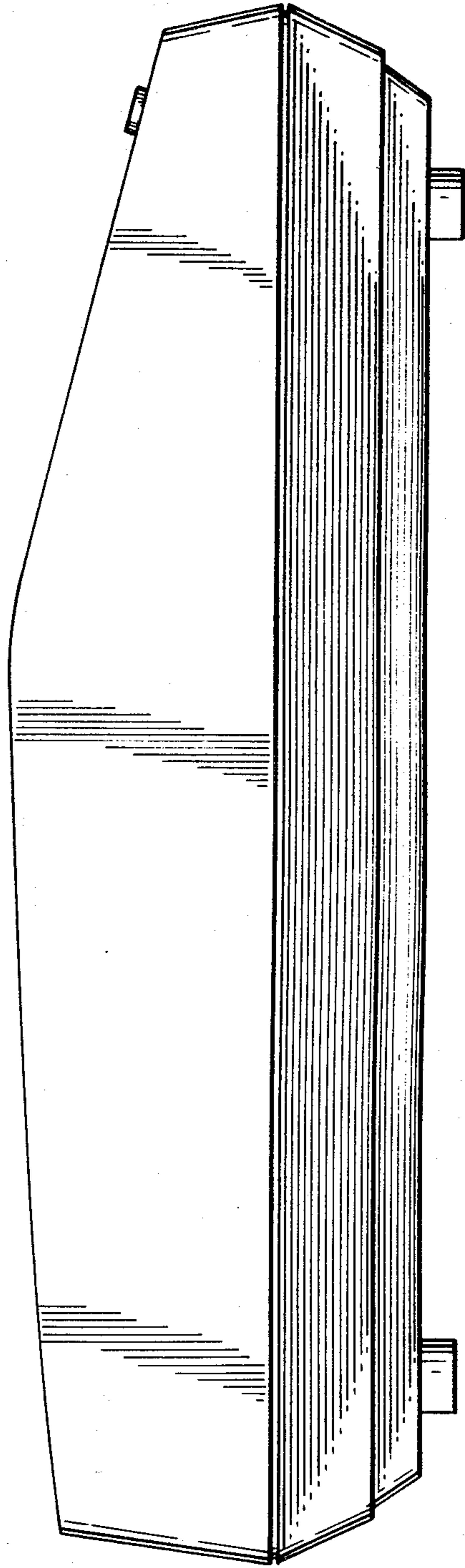

FIG. 5.

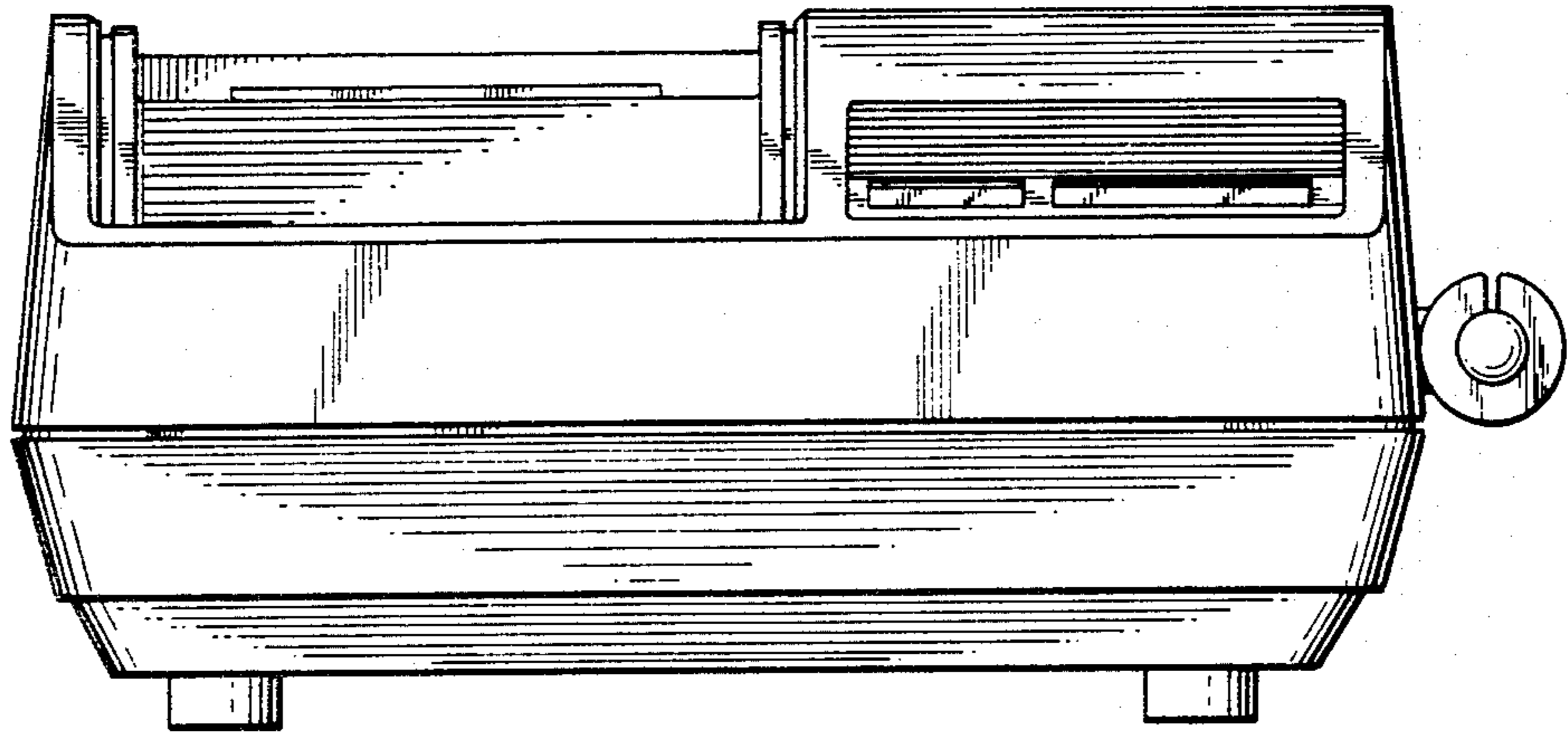

FIG. 6.

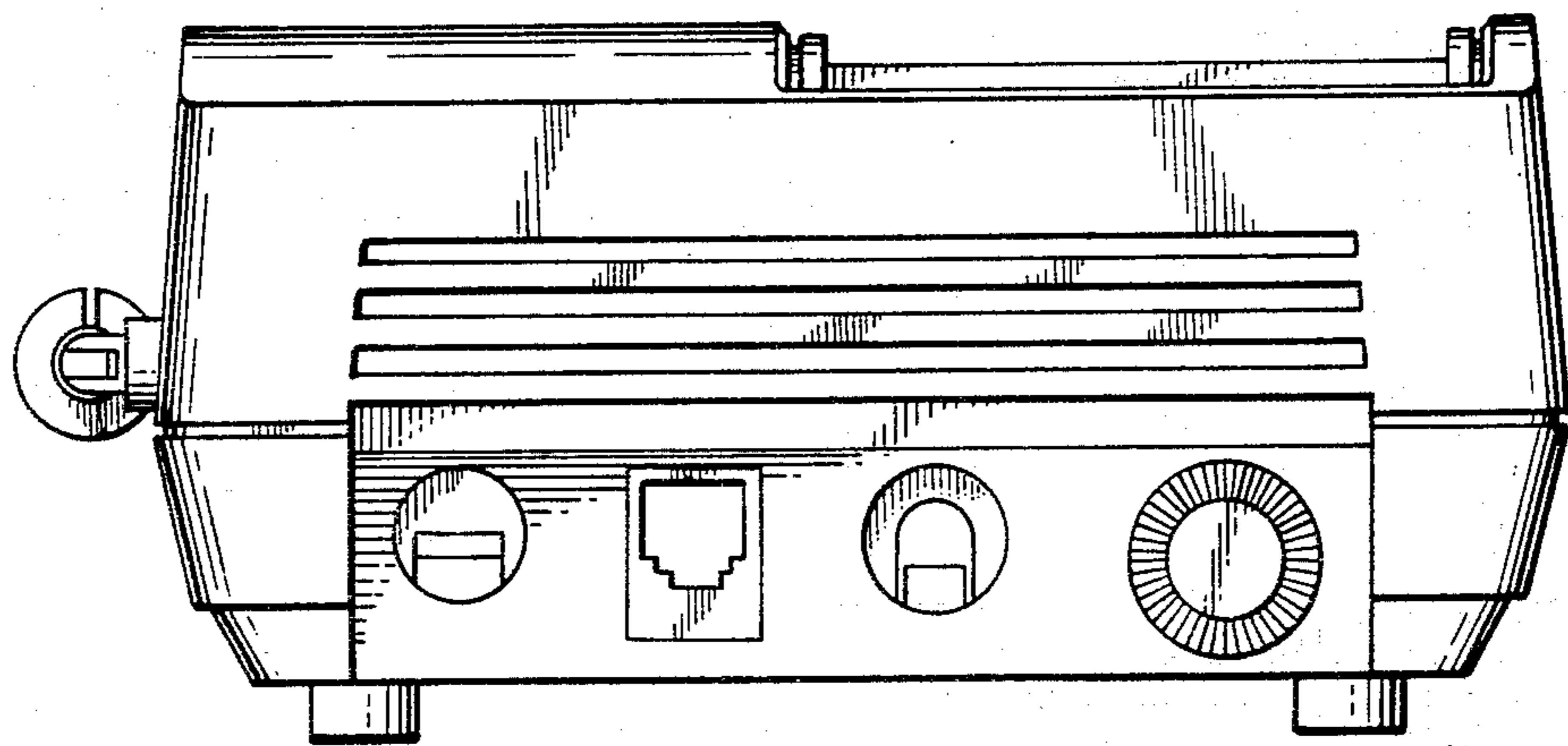

FIG. 7

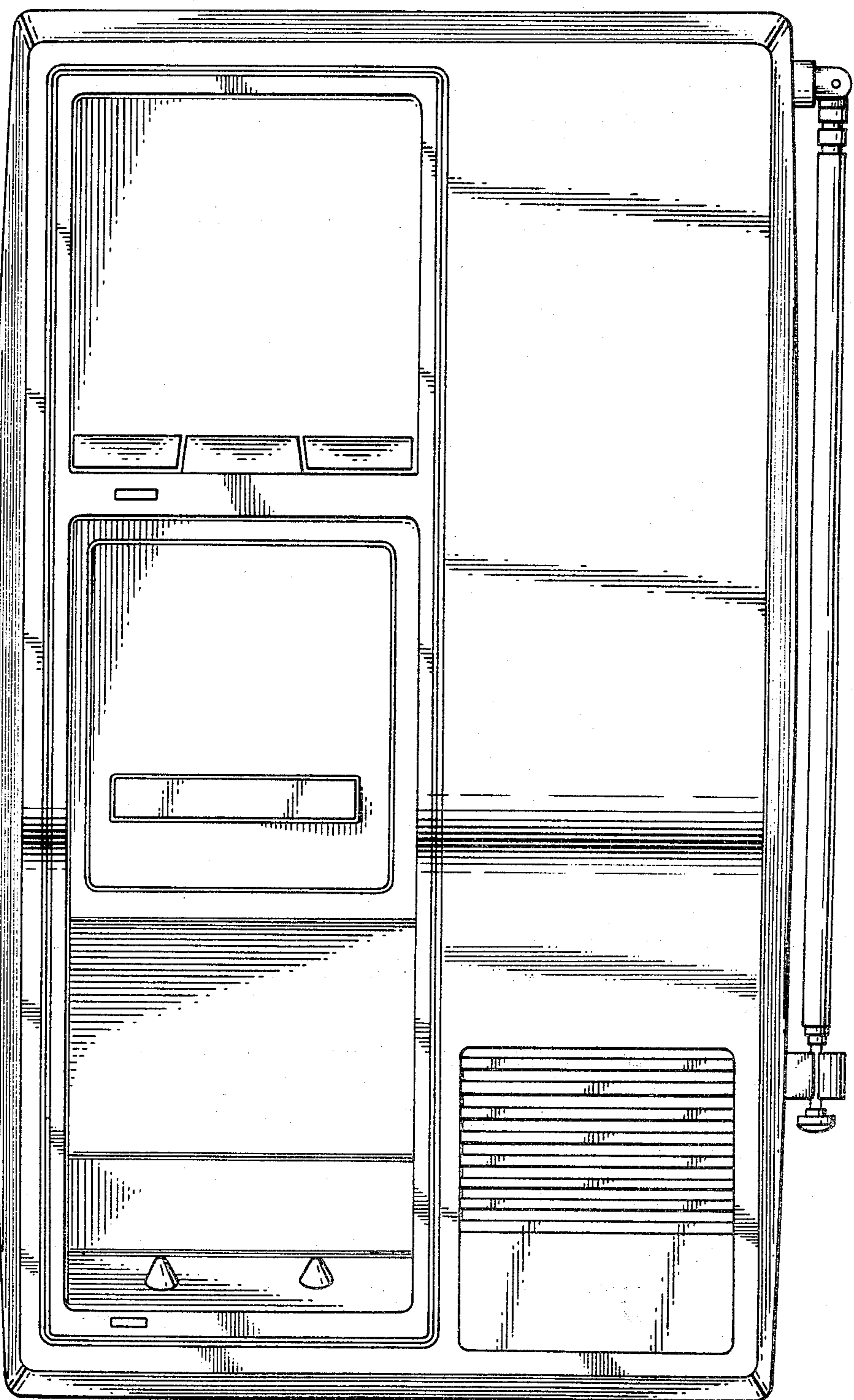

FIG. 8.

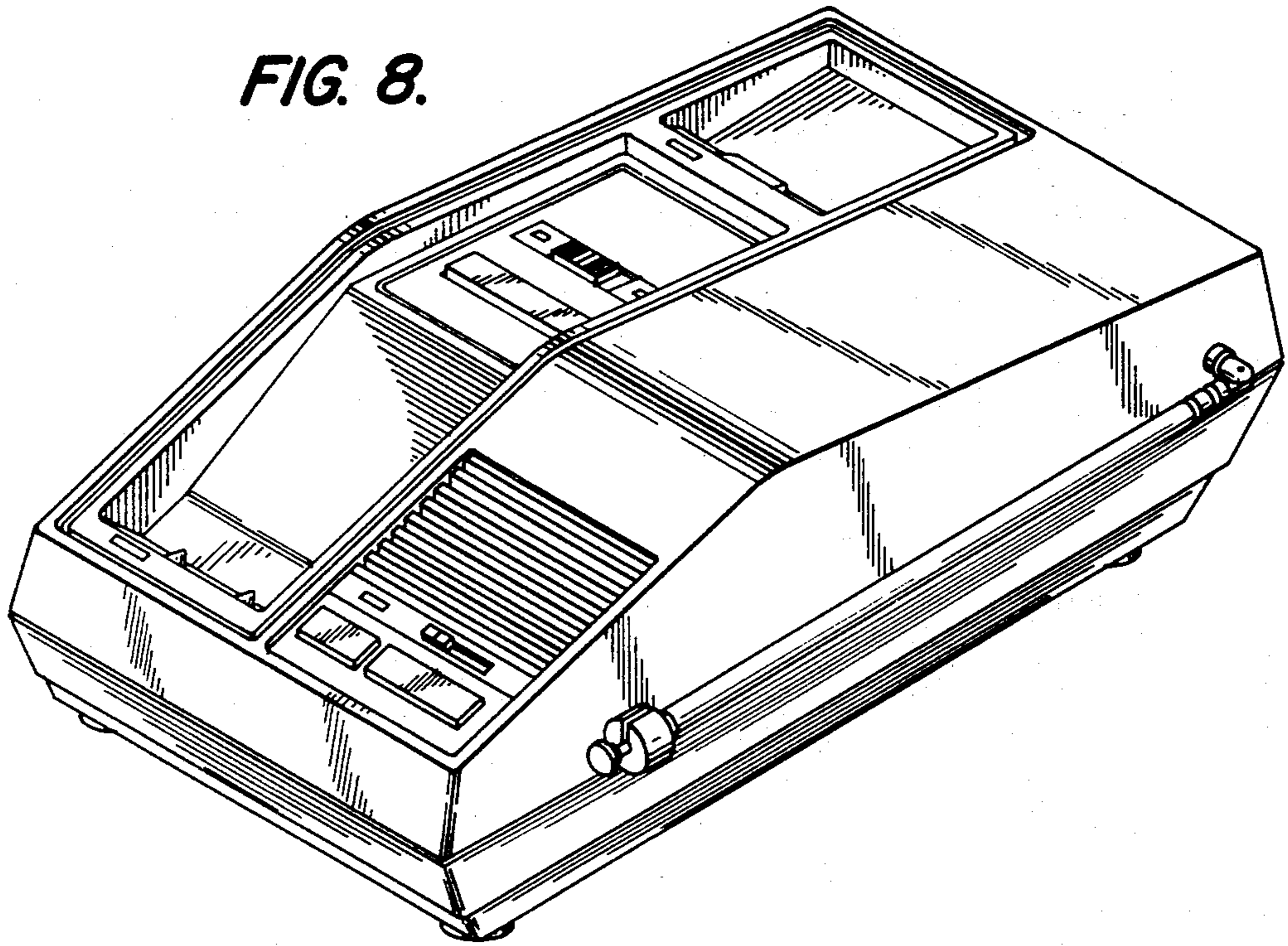

FIG. 9.

