

[54] TOY ROBOT WATCH

[75] Inventor: Takashi Wada, Abiko, Japan

[73] Assignee: Takara Co., Ltd., Tokyo, Japan

[**] Term: 14 Years

[21] Appl. No.: 656,663

[22] Filed: Oct. 1, 1984

[30] Foreign Application Priority Data

May 30, 1984 [JP] Japan 59-22204

[52] U.S. Cl. D10/35; D21/150;
D10/33

[58] Field of Search D10/30-39,
D10/122-126; 446/97, 376, 487; 368/10;
D21/150

[56] References Cited

U.S. PATENT DOCUMENTS

- D. 278,643 4/1985 Ogawa 446/376 X
- D. 279,306 6/1985 Murakami D21/150
- D. 279,592 7/1985 Ogawa D21/150 X
- D. 279,916 7/1985 Obara D21/150 X
- D. 281,001 10/1985 Ohno D21/150 X
- D. 281,088 10/1985 Murakami D21/150
- 4,456,384 6/1984 Murakami 368/10
- 4,482,256 11/1984 Matsuda 368/10
- 4,571,199 2/1986 Murakami 446/73

FOREIGN PATENT DOCUMENTS

- 5944288 5/1984 Japan 446/487

OTHER PUBLICATIONS

Hong Kong Enterprises-10/81-Robot Watch-2nd from left at center.

Primary Examiner-Nelson C. Holtje
Attorney, Agent, or Firm-Price, Gess & Ubell

[57] CLAIM

The ornamental design for a toy robot watch, substantially as shown and described.

DESCRIPTION

FIG. 1 is a front elevational view of a toy robot watch showing my new design;

FIG. 2 is a right side elevational view thereof;

FIG. 3 is a left side elevational view thereof;

FIG. 4 is a rear elevational view thereof;

FIG. 5 is a top plan view thereof;

FIG. 6 is a bottom plan view thereof;

FIG. 7 is a right front perspective view of the holder/strap portion with the robot-watch omitted for clarity of illustration;

FIG. 8 is a front elevational view of the robot-watch portion with the holder/strap omitted for clarity of illustration;

FIG. 9 is a right side elevational view of FIG. 8, the left side being a mirror image thereof;

FIG. 10 is a rear elevational view of FIG. 8;

FIG. 11 is a top plan view of FIG. 8;

FIG. 12 is a bottom plan view of FIG. 8;

FIG. 13 is a front elevational view of FIG. 8 with portions thereof in alternate positions;

FIG. 14 is a right side elevational view of FIG. 13, the left side being a mirror image thereof;

FIG. 15 is a rear elevational view of FIG. 13;

FIG. 16 is a top plan view of FIG. 13;

FIG. 17 is a bottom plan view of FIG. 13.

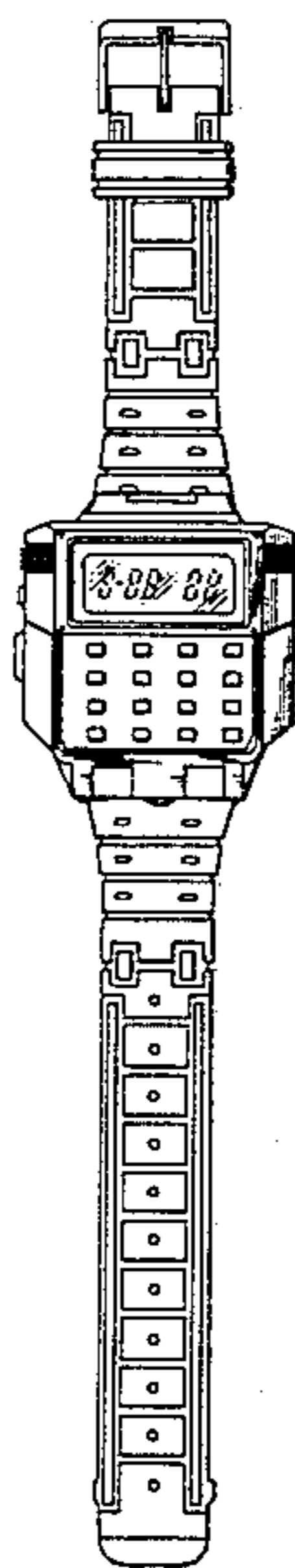

FIG. 1

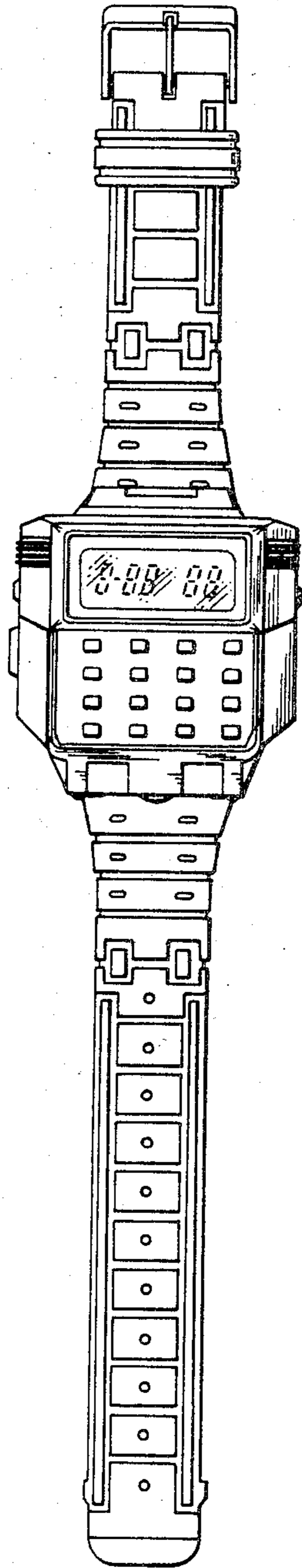

FIG. 2

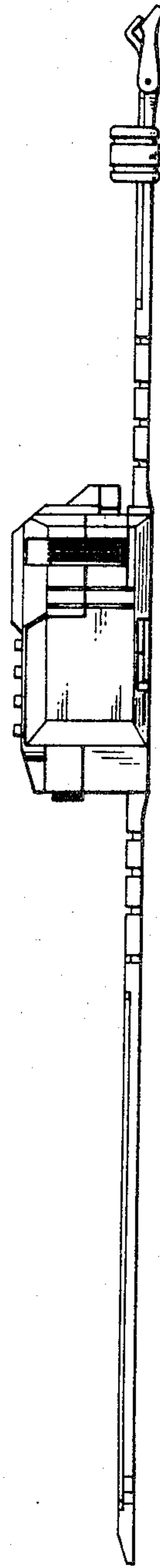

FIG. 3

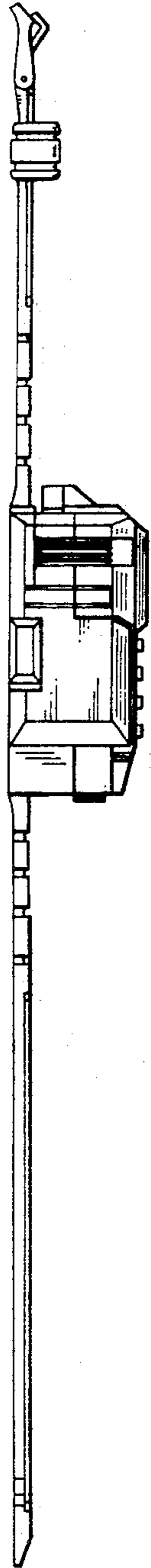

FIG. 4

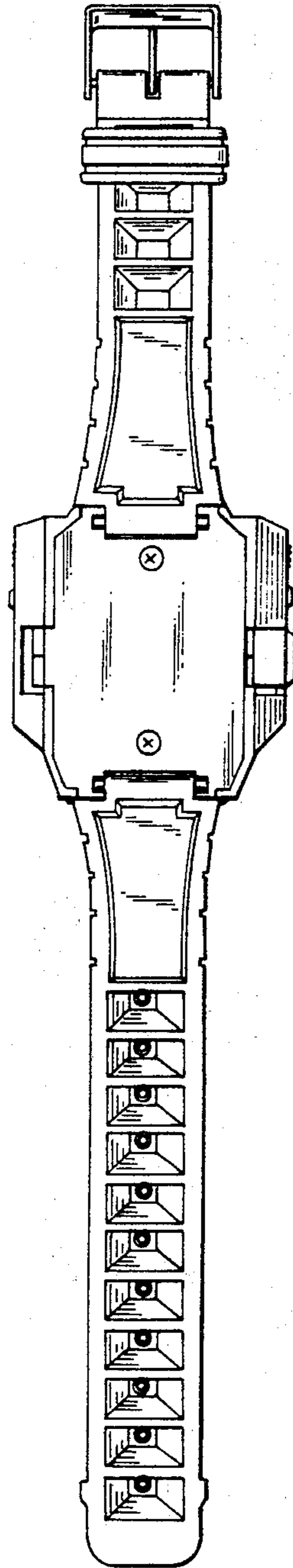

FIG. 5

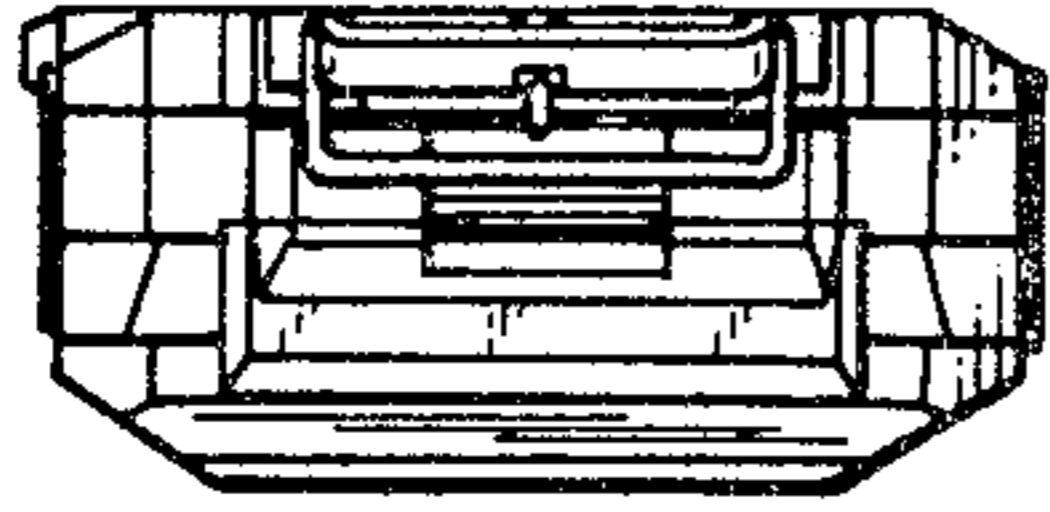

FIG. 6

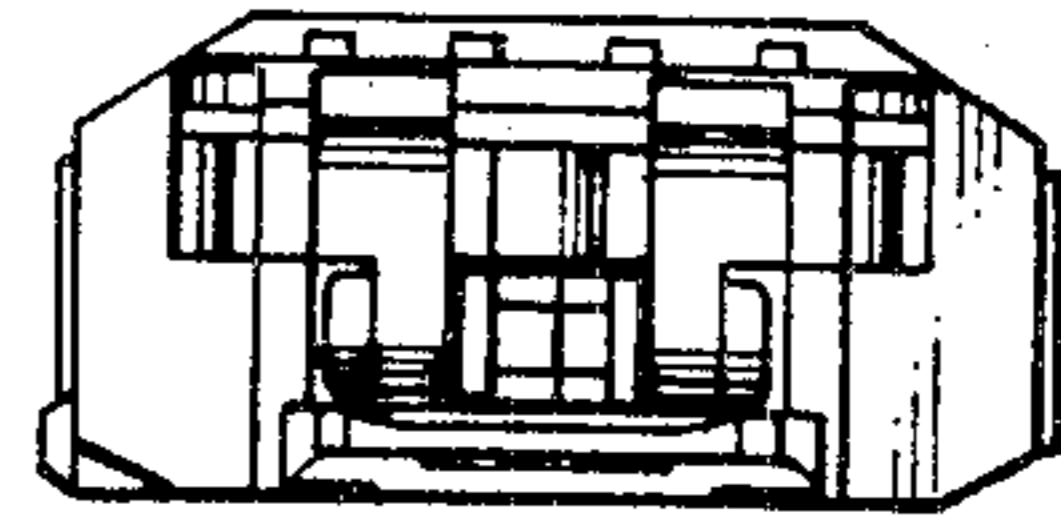

FIG. 7

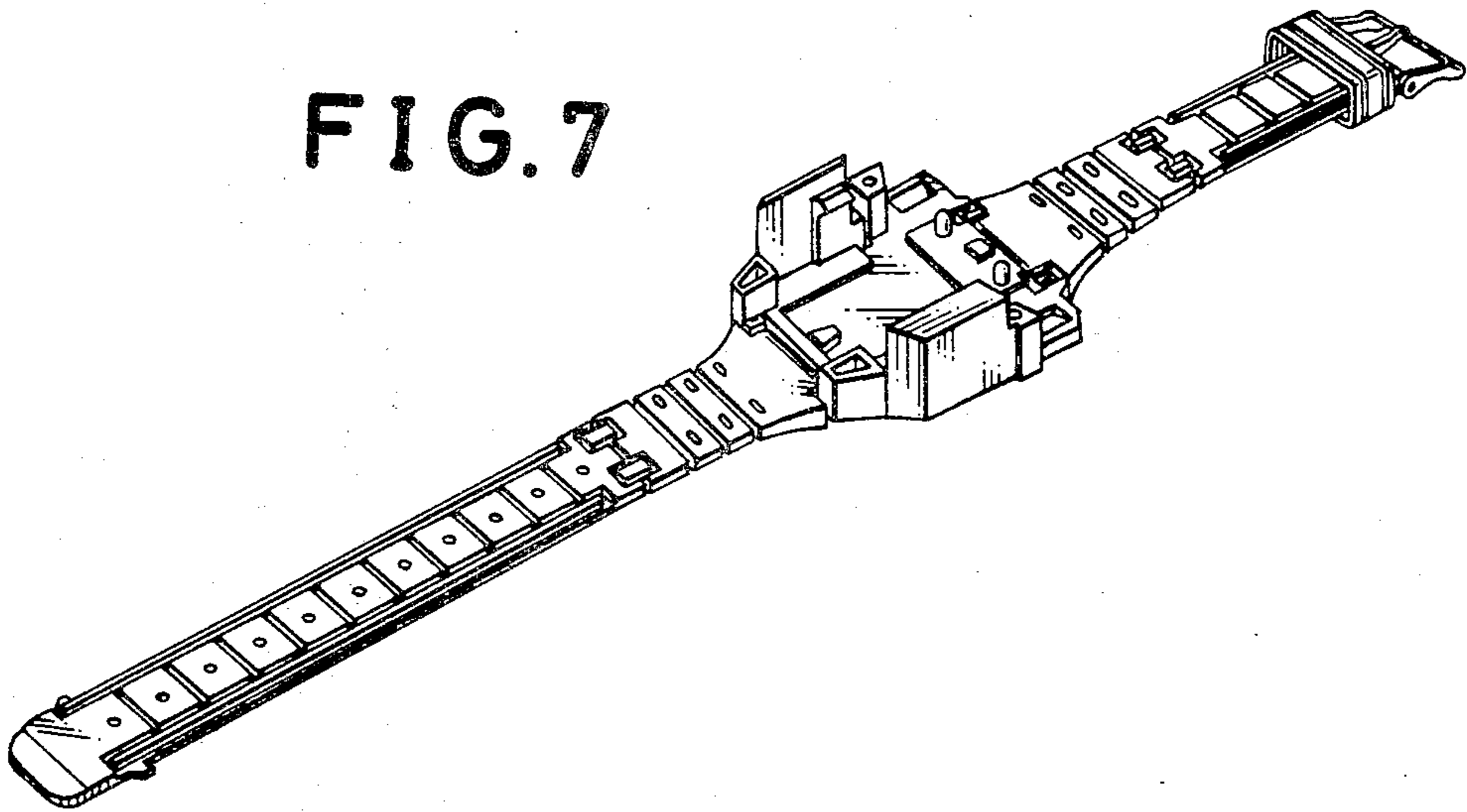

FIG. 8

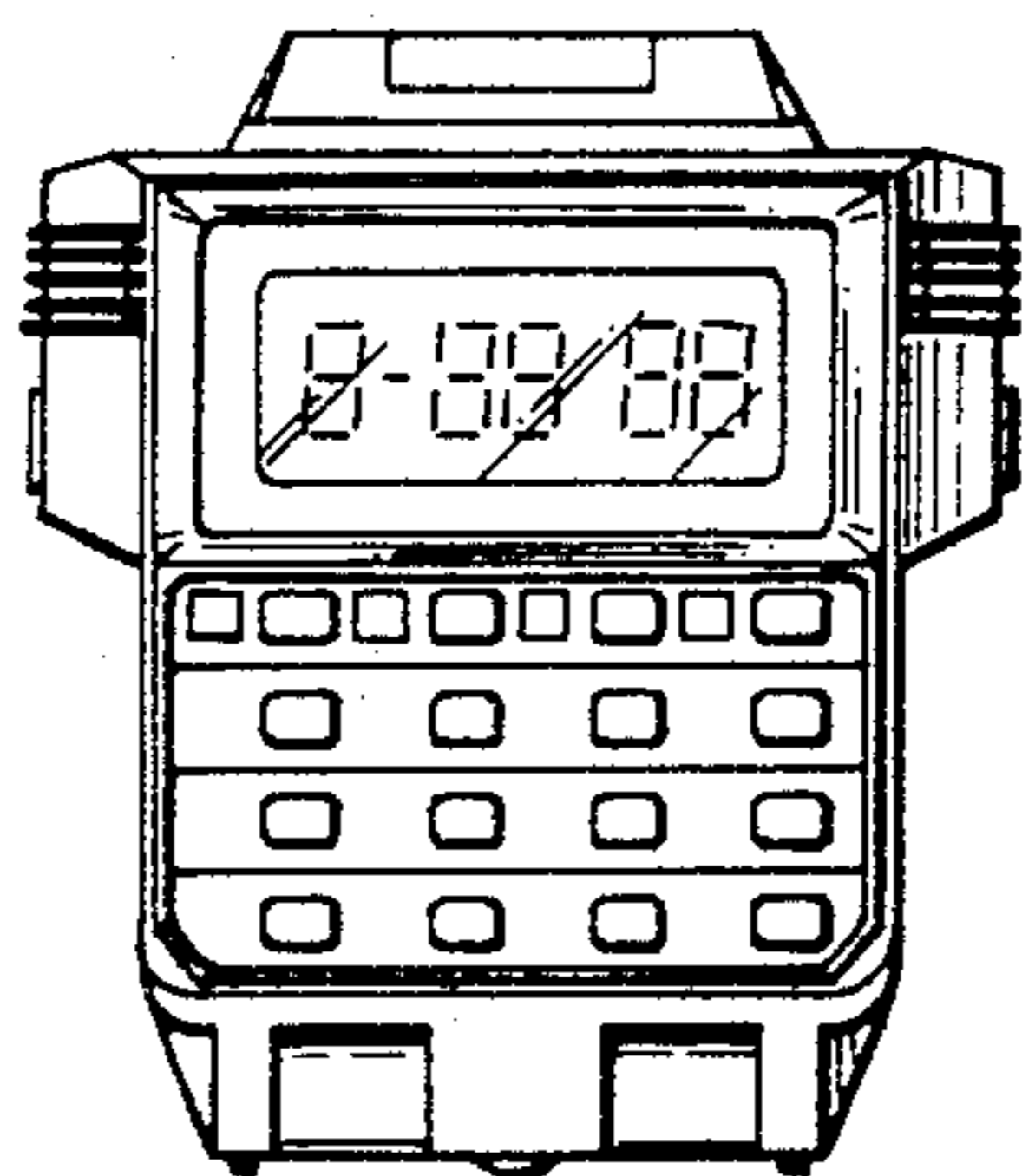

FIG. 9

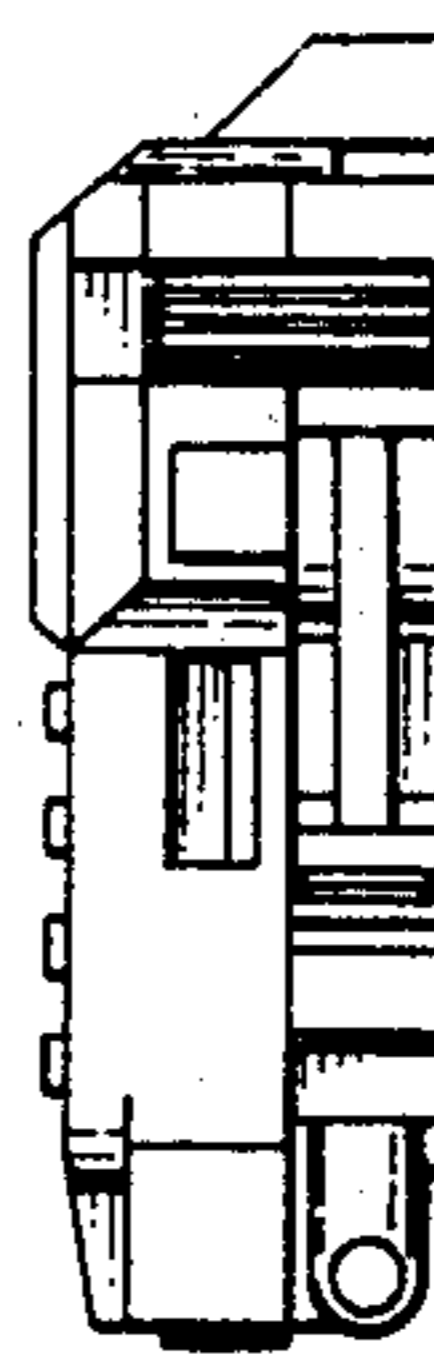

FIG. 10

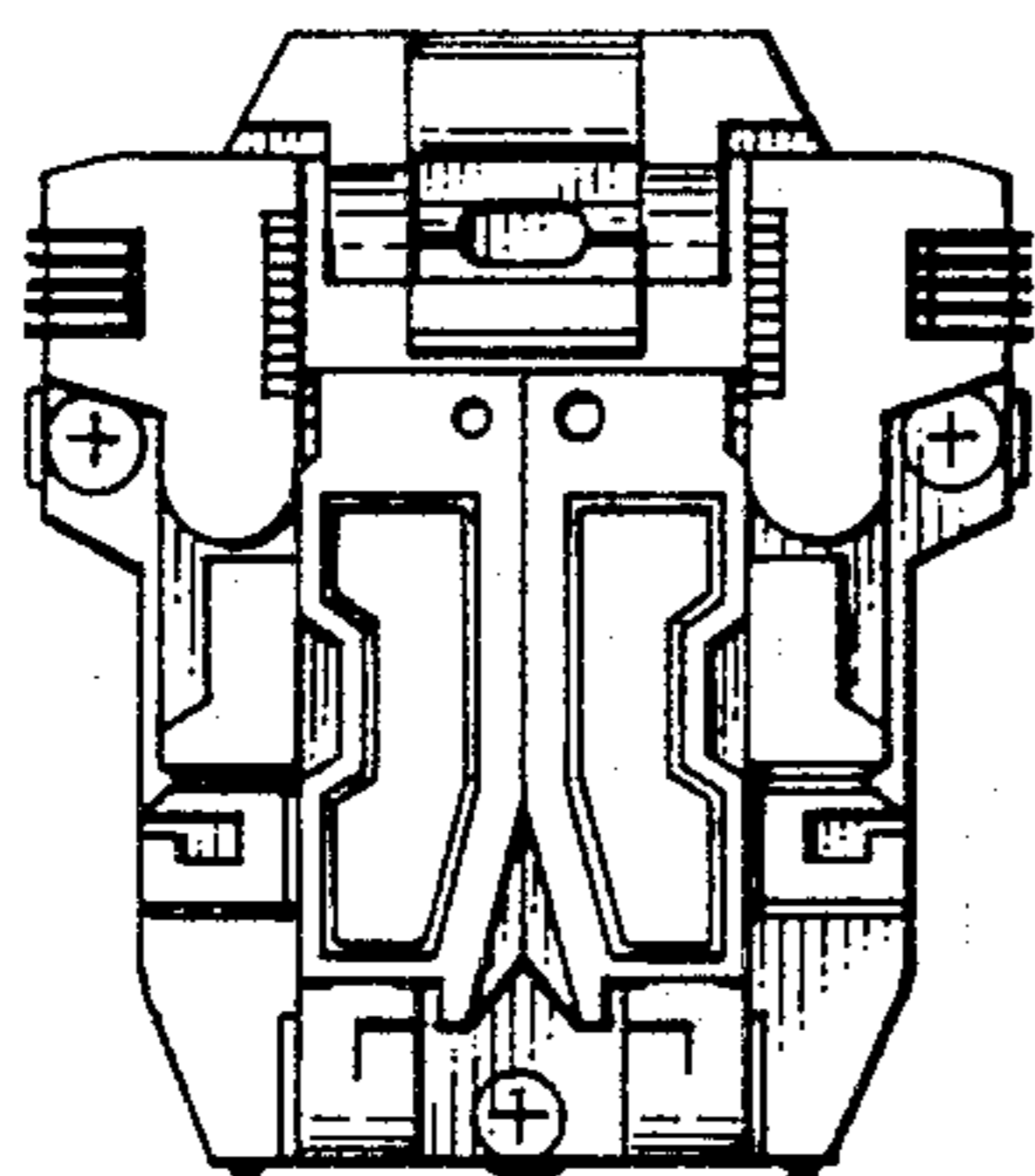

FIG. 11

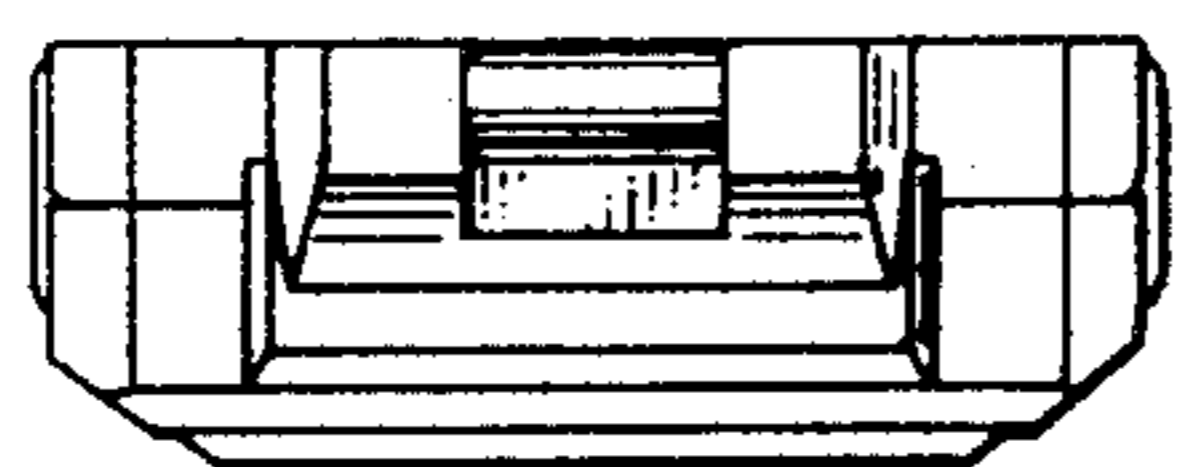

FIG. 12

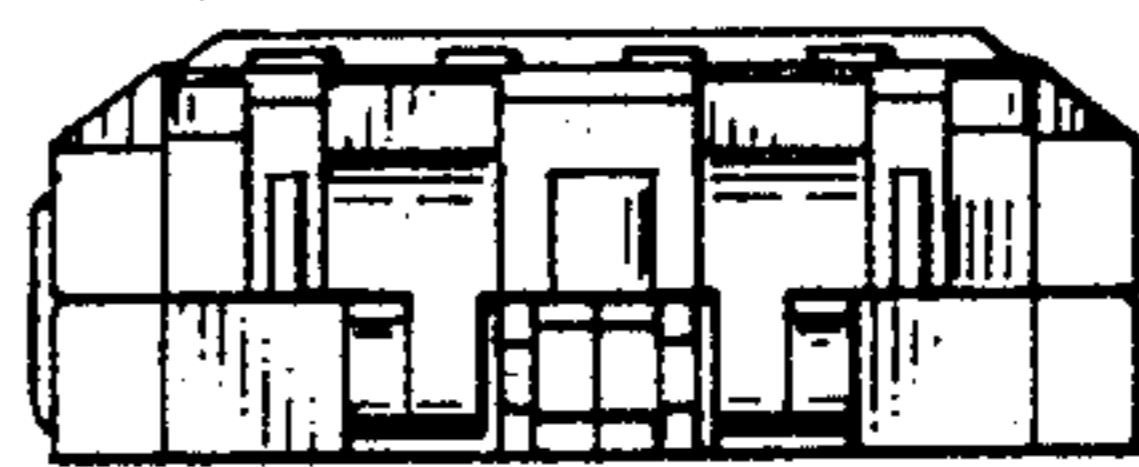

FIG. 13

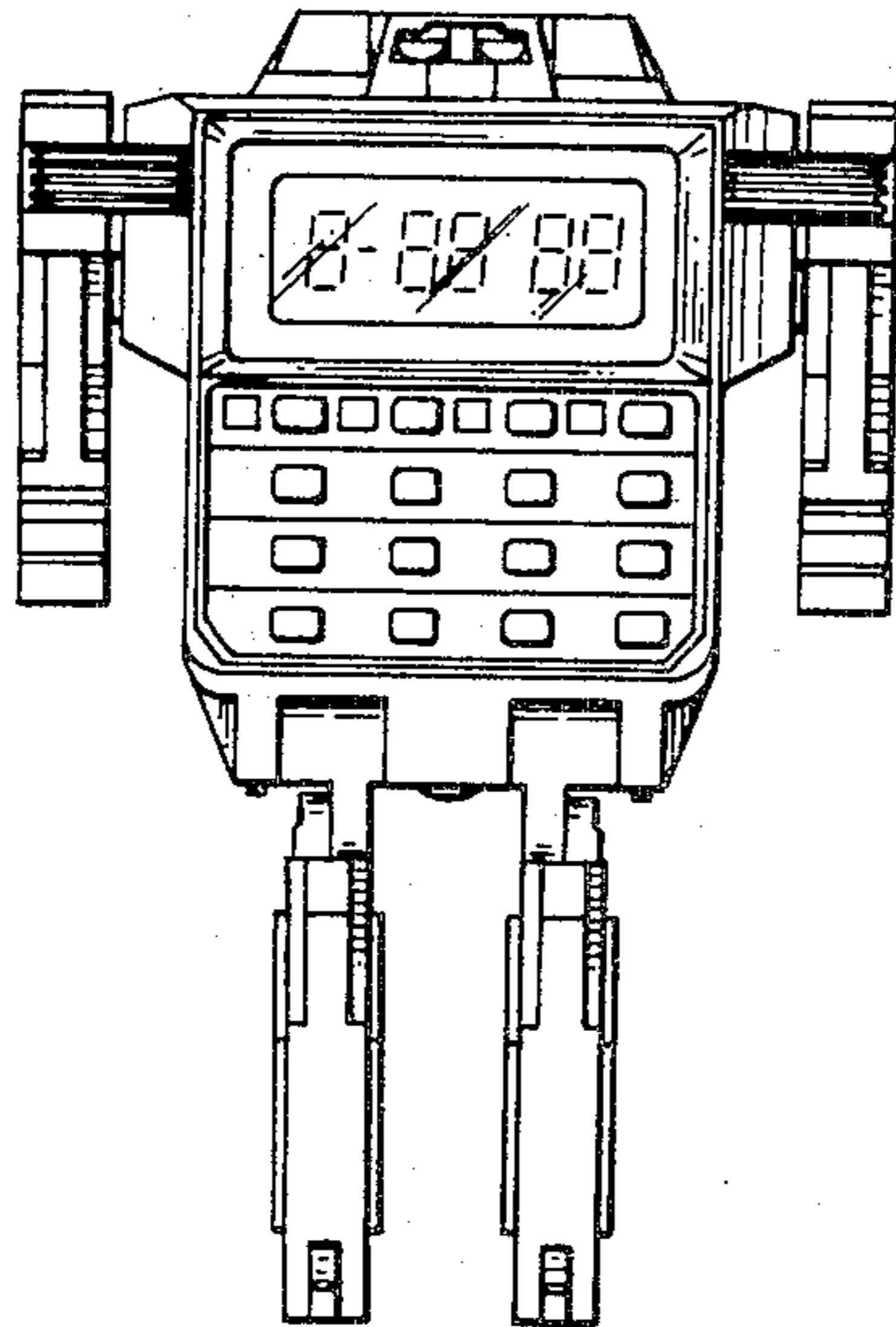

FIG. 14

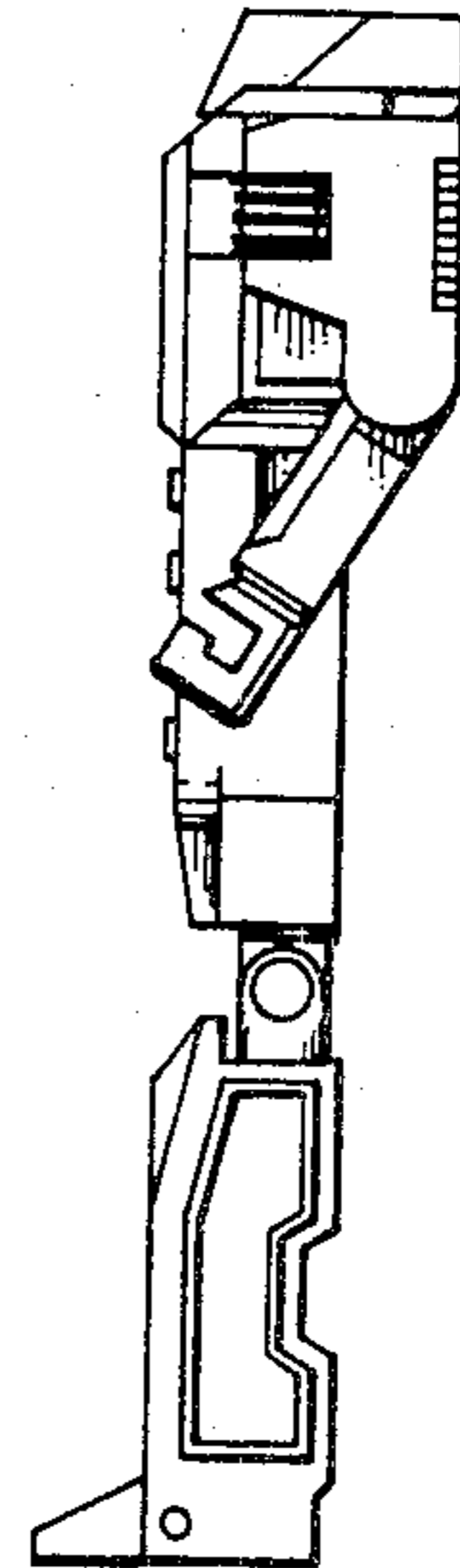

FIG. 15

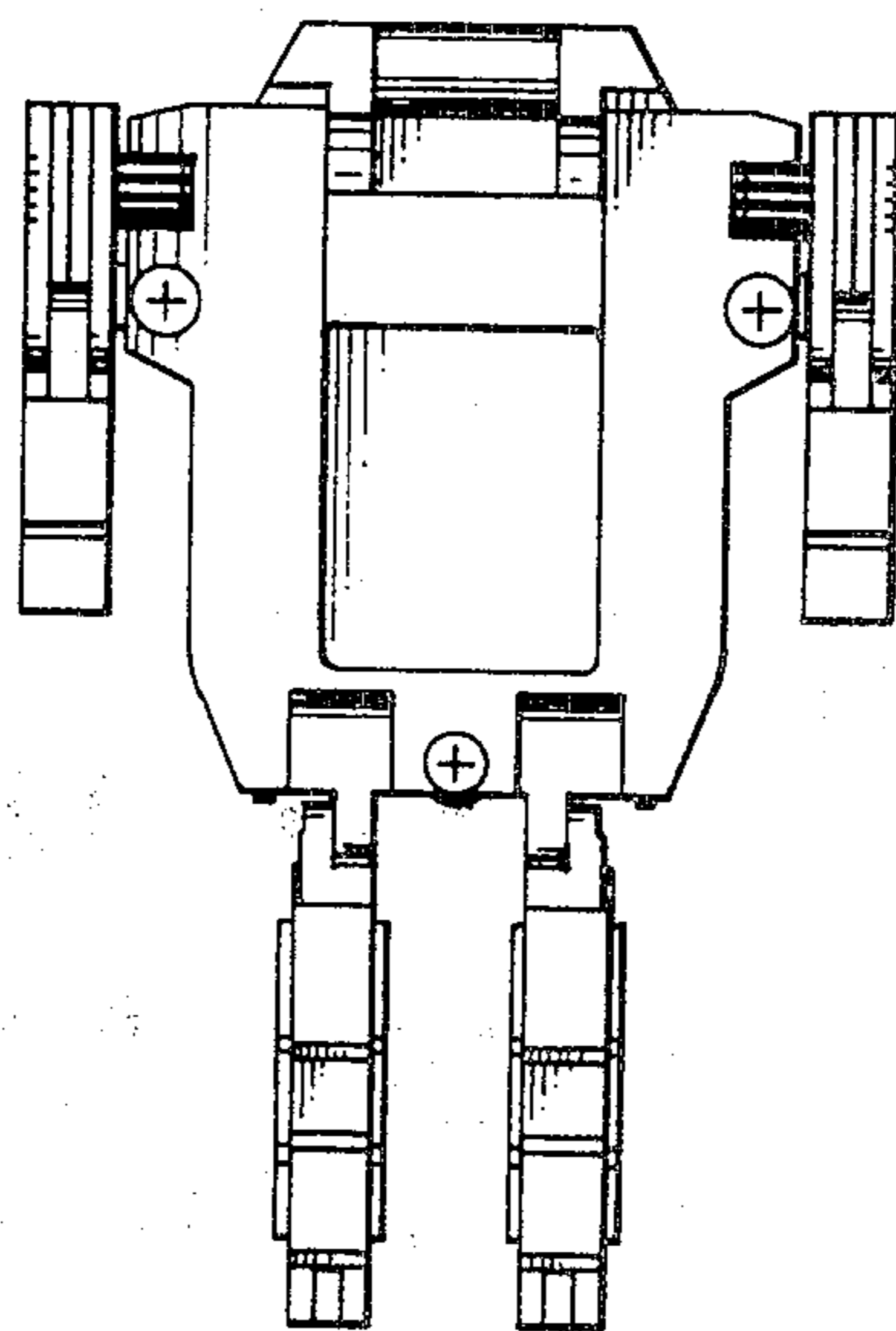

FIG. 16

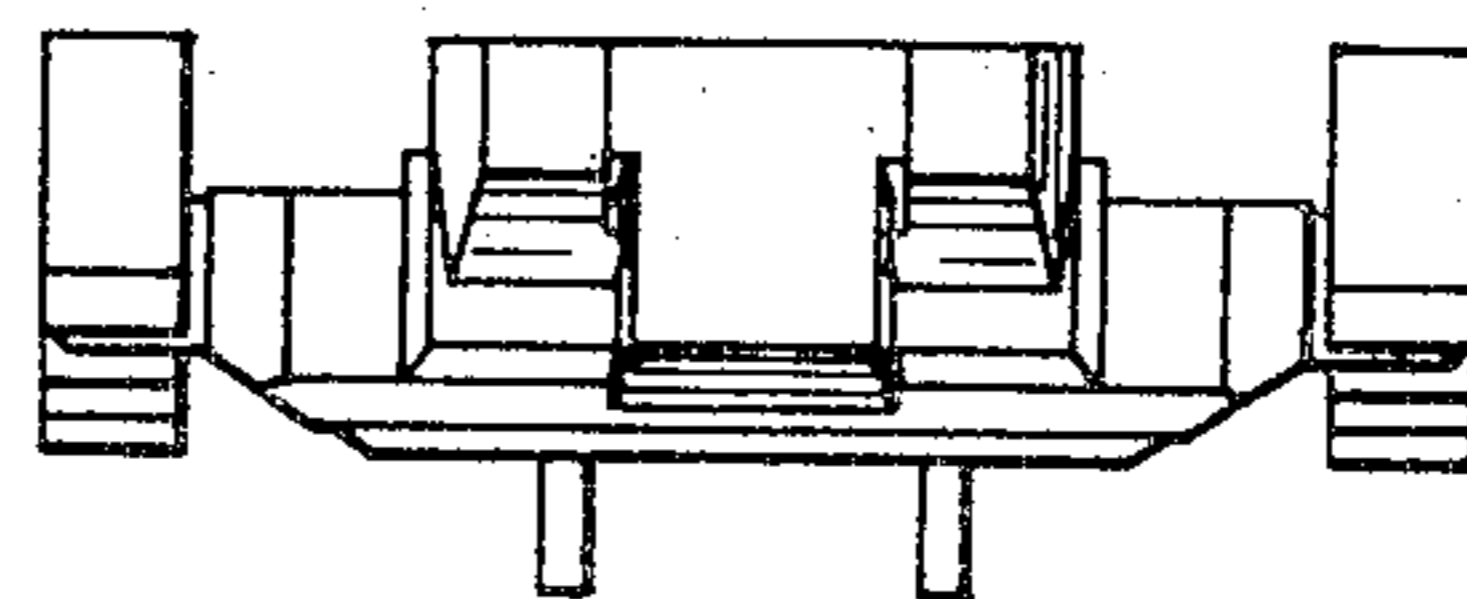

FIG. 17

