

[54] GLUE DISPENSER

[75] Inventor: Vittorio Pappalardo, Pessano Con Bornago, Italy

[73] Assignee: B.V.A.S. r.l., Milan, Italy

[**] Term: 14 Years

[21] Appl. No.: 719,997

[22] Filed: Apr. 4, 1985

[52] U.S. Cl. D19/66; D19/68; D19/71

[58] Field of Search D19/66-71; 156/527, 584, 523, 524

[56] References Cited

U.S. PATENT DOCUMENTS

D. 146,718	4/1947	Hudson	D19/69
D. 177,214	3/1956	Castelli et al.	D19/69
D. 177,224	3/1956	Gershen	D19/69

D. 186,147	9/1959	Littman	D19/71
D. 188,150	6/1960	Greshen	D19/69
D. 275,321	8/1984	Heinzelman et al.	D19/69
2,582,980	2/1950	Fritzinger	D19/69
3,351,511	6/1965	Petterson	
4,345,966	8/1982	Iiyama et al.	

Primary Examiner—George P. Word
Attorney, Agent, or Firm—Shlesinger Fitzsimmons Shlesinger

[57] CLAIM

The ornamental design for a glue dispenser, as shown.

DESCRIPTION

FIG. 1 is a right-side elevational view of a glue dispenser showing my new design; FIG. 2 is a left-side elevational view thereof; FIG. 3 is a top plan view thereof; FIG. 4 is a bottom plan view thereof; FIG. 5 is a front elevational view thereof; and FIG. 6 is a rear elevational view thereof.

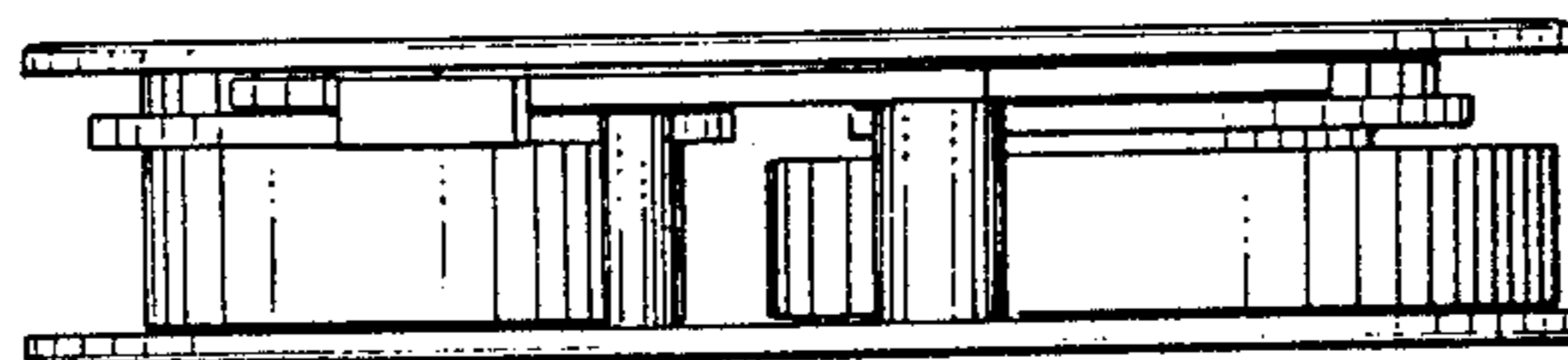
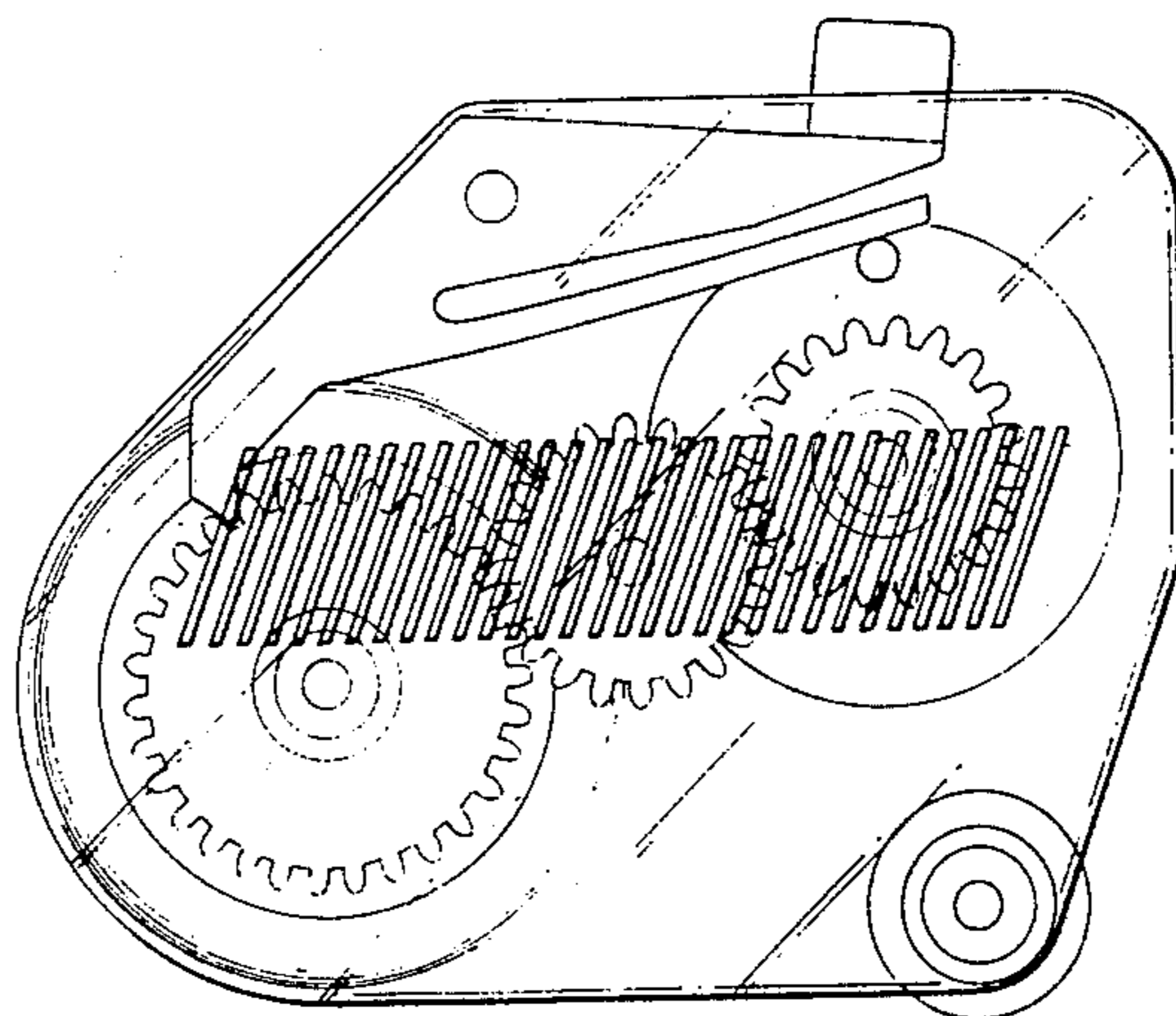

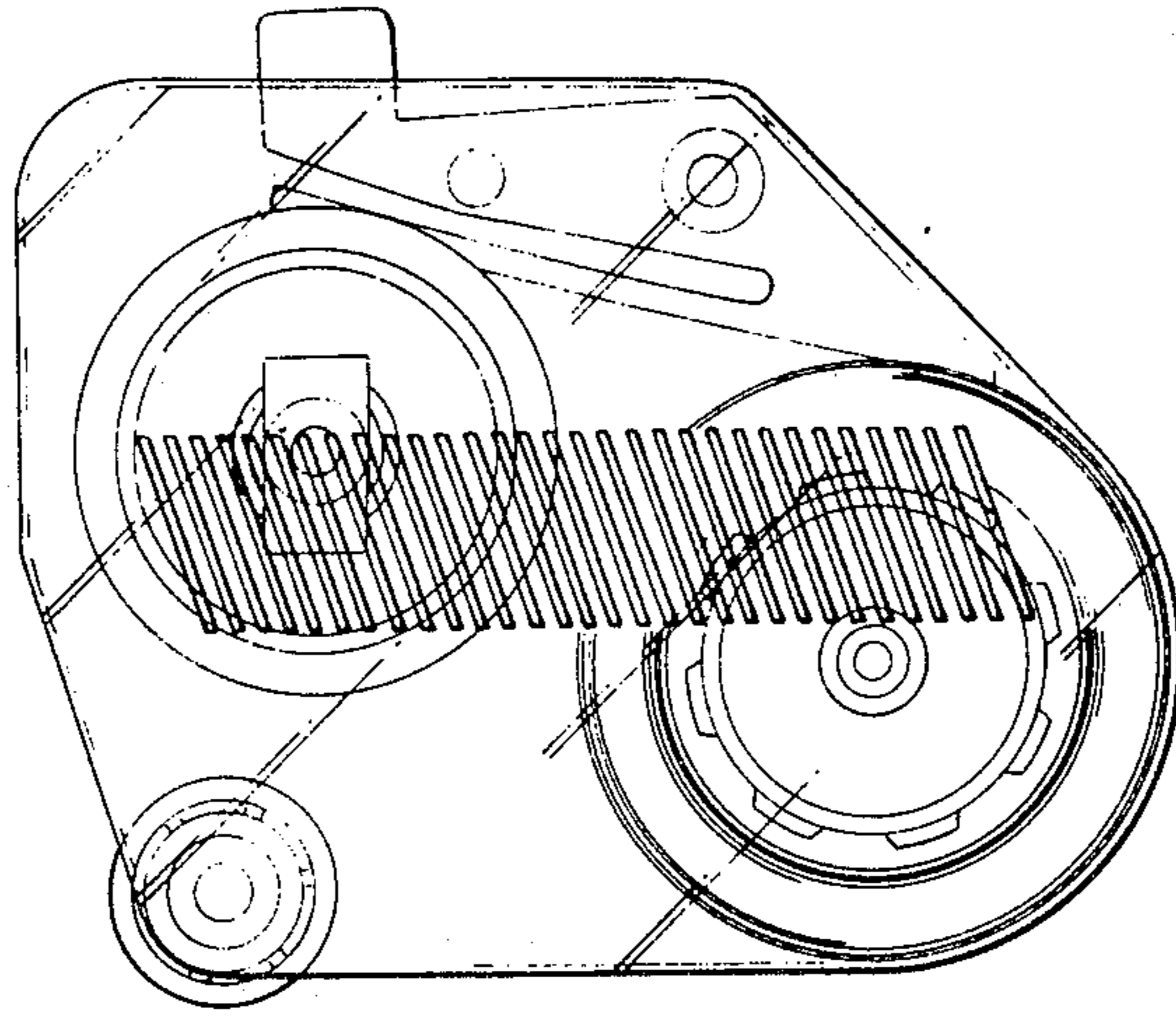

Fig. 1

Fig. 2

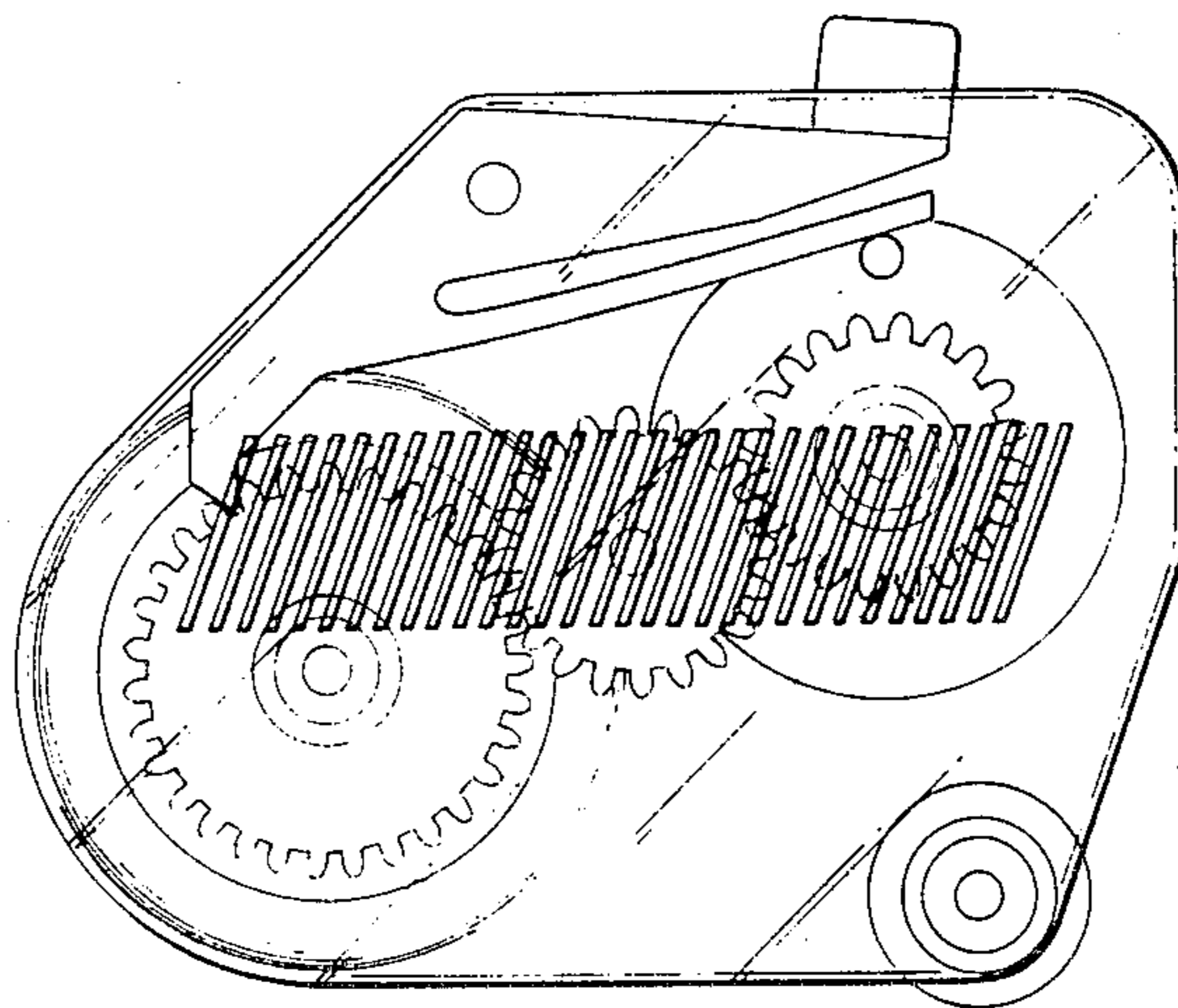

Fig. 5

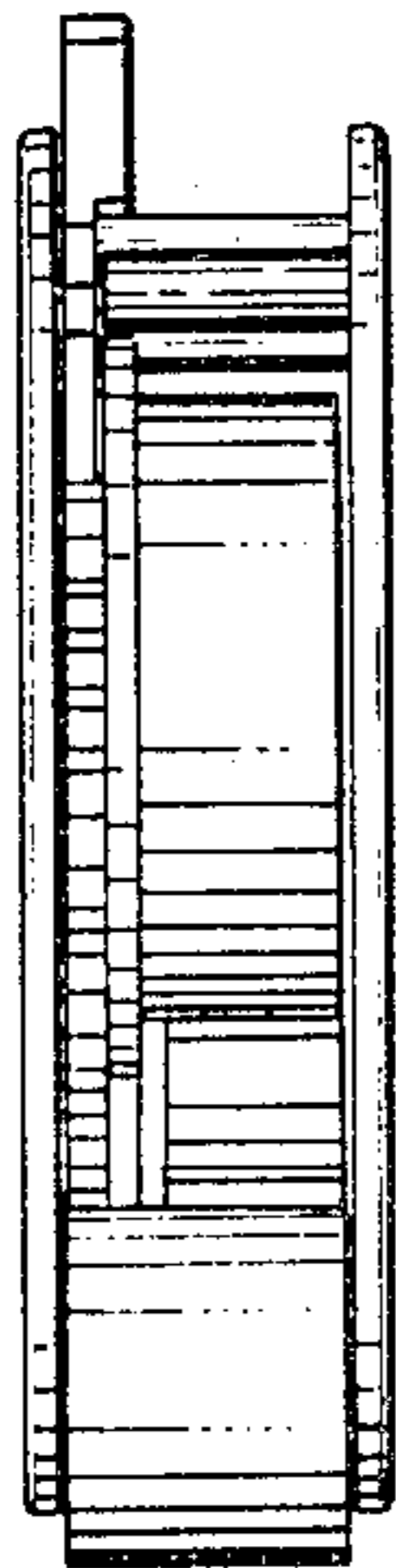

Fig. 3

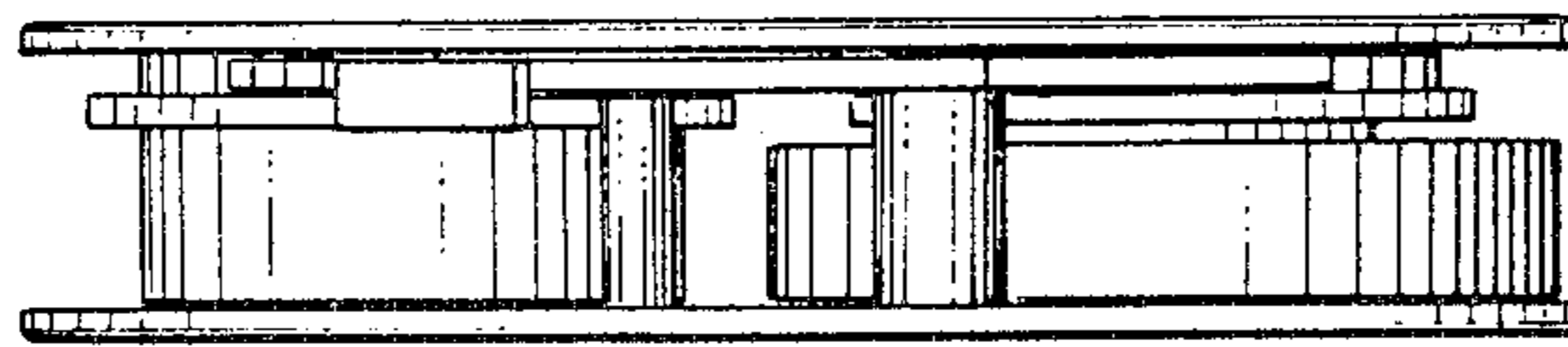

Fig. 4

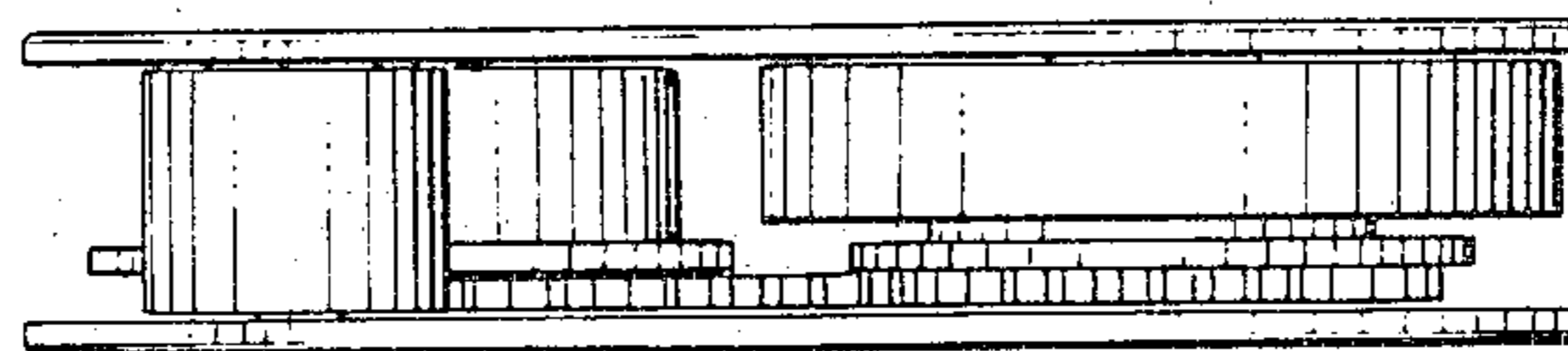

Fig. 6

