

[54] HOLDER FOR STERILIZING JAR LIDS OR SIMILAR ARTICLES

[75] Inventor: John Rankin, Milwaukie, Oreg.

[73] Assignee: Nordic Products, Inc., Mountlake Terrace, Wash.

[**] Term: 14 Years

[21] Appl. No.: 608,333

[22] Filed: May 8, 1984

[52] U.S. Cl. D8/14; D6/512; D6/525; D6/566; D6/573; D6/574; D7/409; D34/28

[58] Field of Search D6/310, 314, 320-323, D6/462, 463, 512, 513, 515, 517, 524, 525, 526, 536, 540, 552, 553, 546, 555, 559, 562, 566, 567, 569, 570, 571, 573, 574; 211/13, 32, 35, 38, 40, 41, 46, 48, 59.2, 60.1, 68, 70.5, 70.6, 71, 72, 74, 75, 87, 88, 104, 105, 106, 113, 117, 126, 133, 181; 248/75, 111, 158, 312, 312.1, 313, 314; D7/99, 102, 103, 407; D8/14

[56] References Cited

U.S. PATENT DOCUMENTS

D. 258,212	2/1981	Negrete	D7/409
D. 279,161	6/1985	Gould	D8/14
D. 279,859	7/1985	Faust	D8/14
D. 919,896	4/1909	Lemke	211/41
4,316,545	2/1982	Hartnell	211/70.6

Primary Examiner—B. J. Bullock
Assistant Examiner—Suzanne N. Gitlin
Attorney, Agent, or Firm—Ward Brown; Robert W. Beach

[57] CLAIM

The ornamental design for a holder for sterilizing jar lids or similar articles, substantially as shown and described.

DESCRIPTION

FIG. 1 is a top perspective view of a holder for sterilizing jar lids and similar articles showing my new design; FIG. 2 is a top plan view thereof; FIG. 3 is a bottom plan view thereof; FIG. 4 is a rear elevational view thereof; FIG. 5 is a front elevational view thereof; FIG. 6 is a side elevational view taken from the left of FIG. 5; and FIG. 7 is a side elevational view taken from the right of FIG. 5.

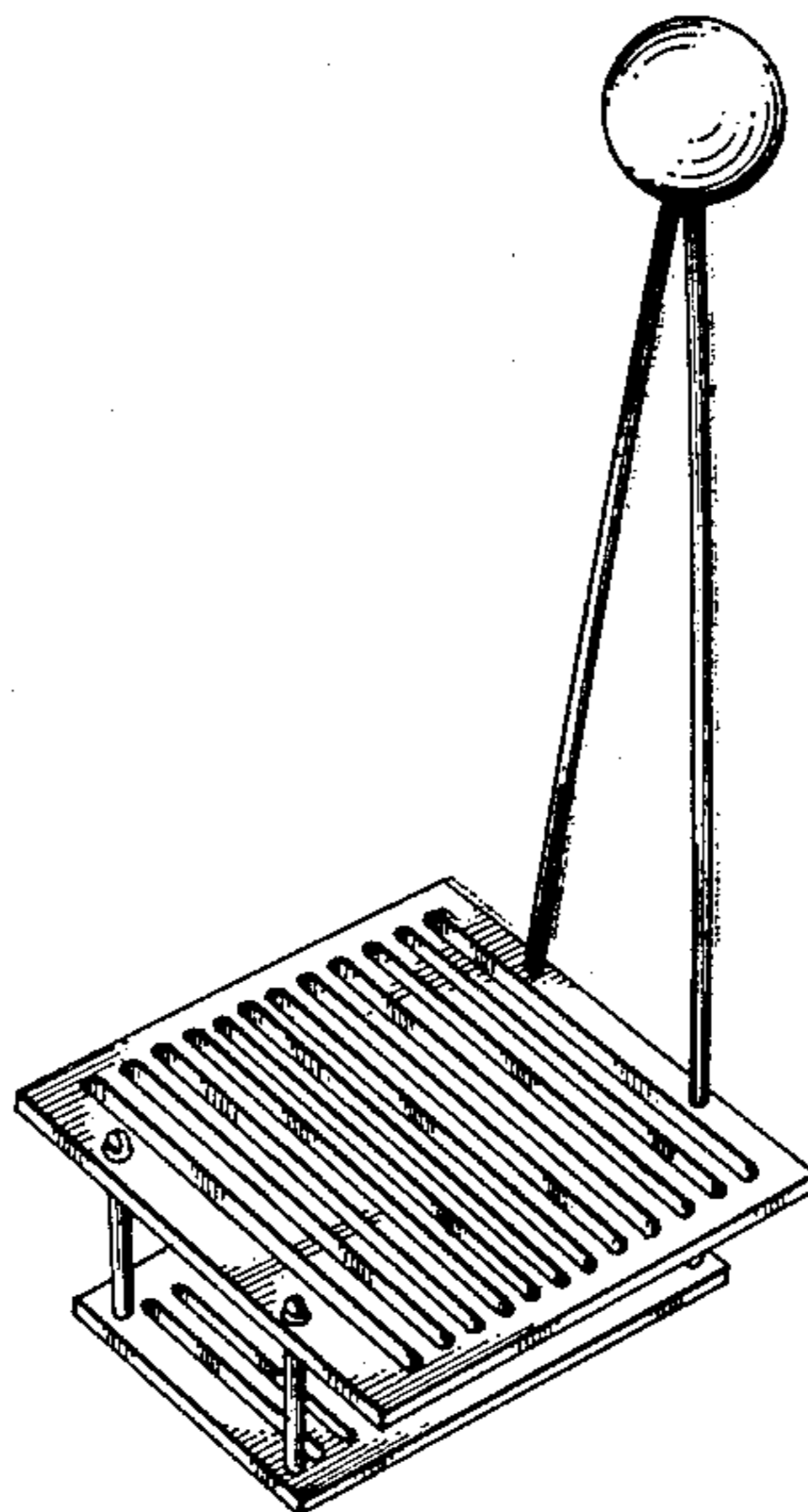

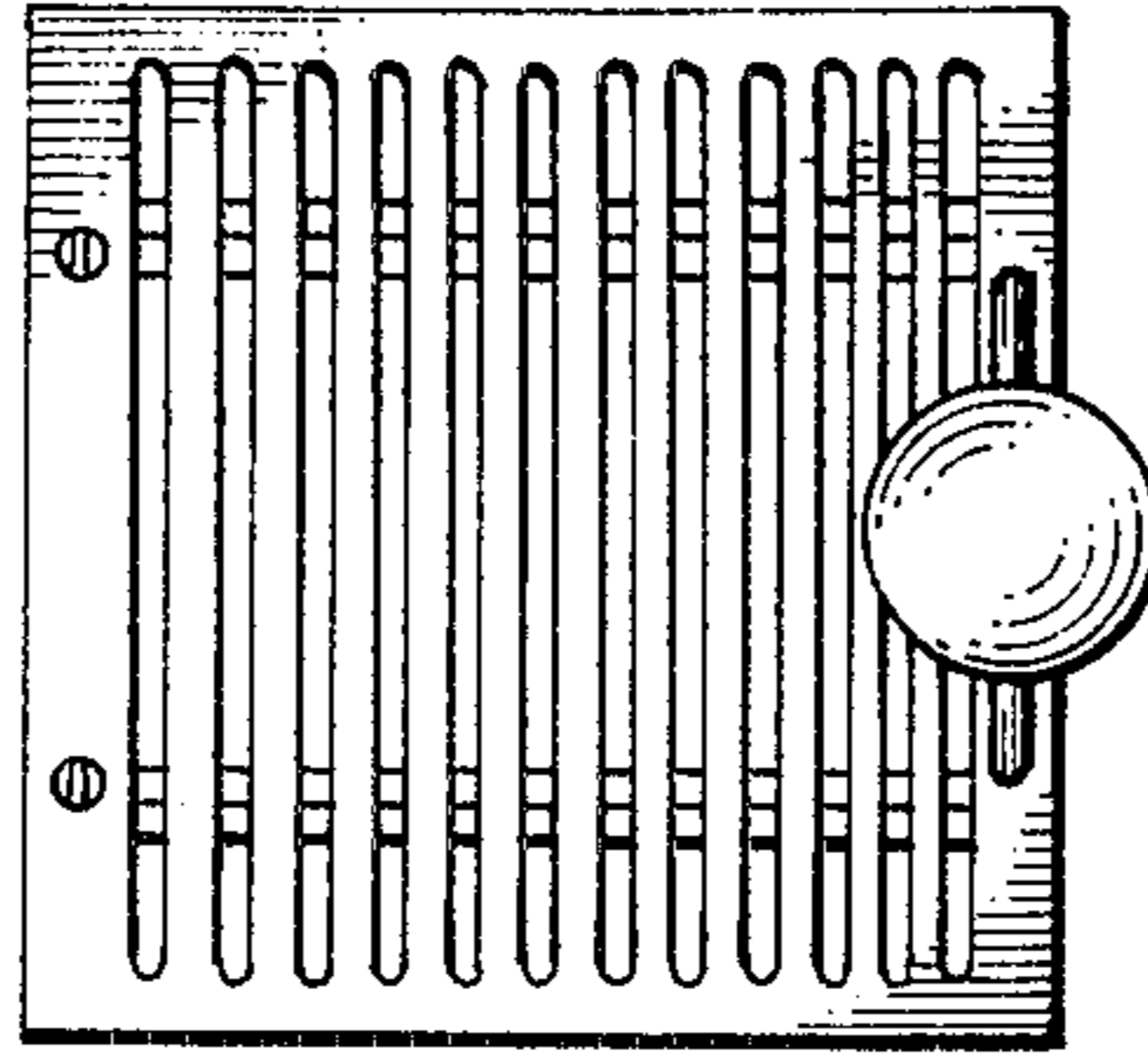

Fig. 2

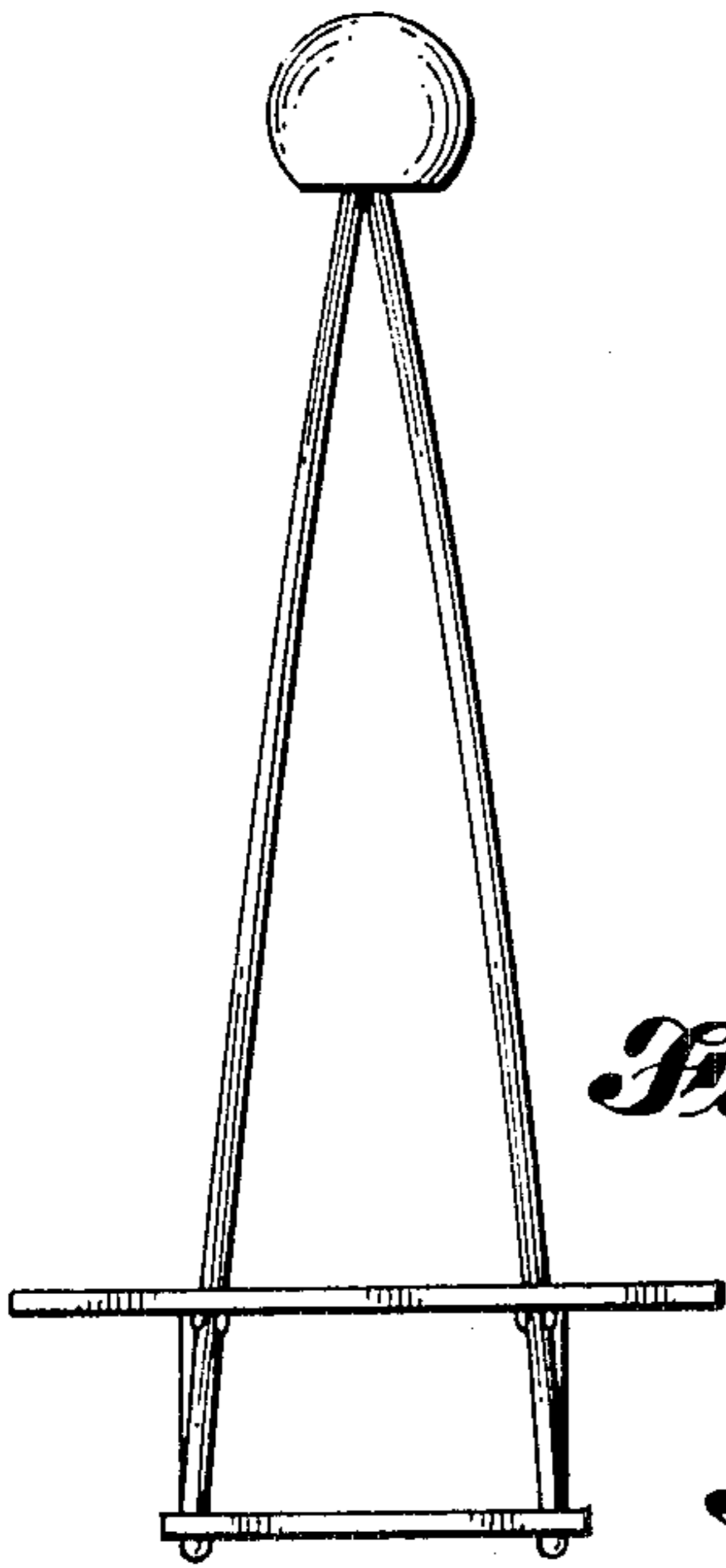

Fig. 4

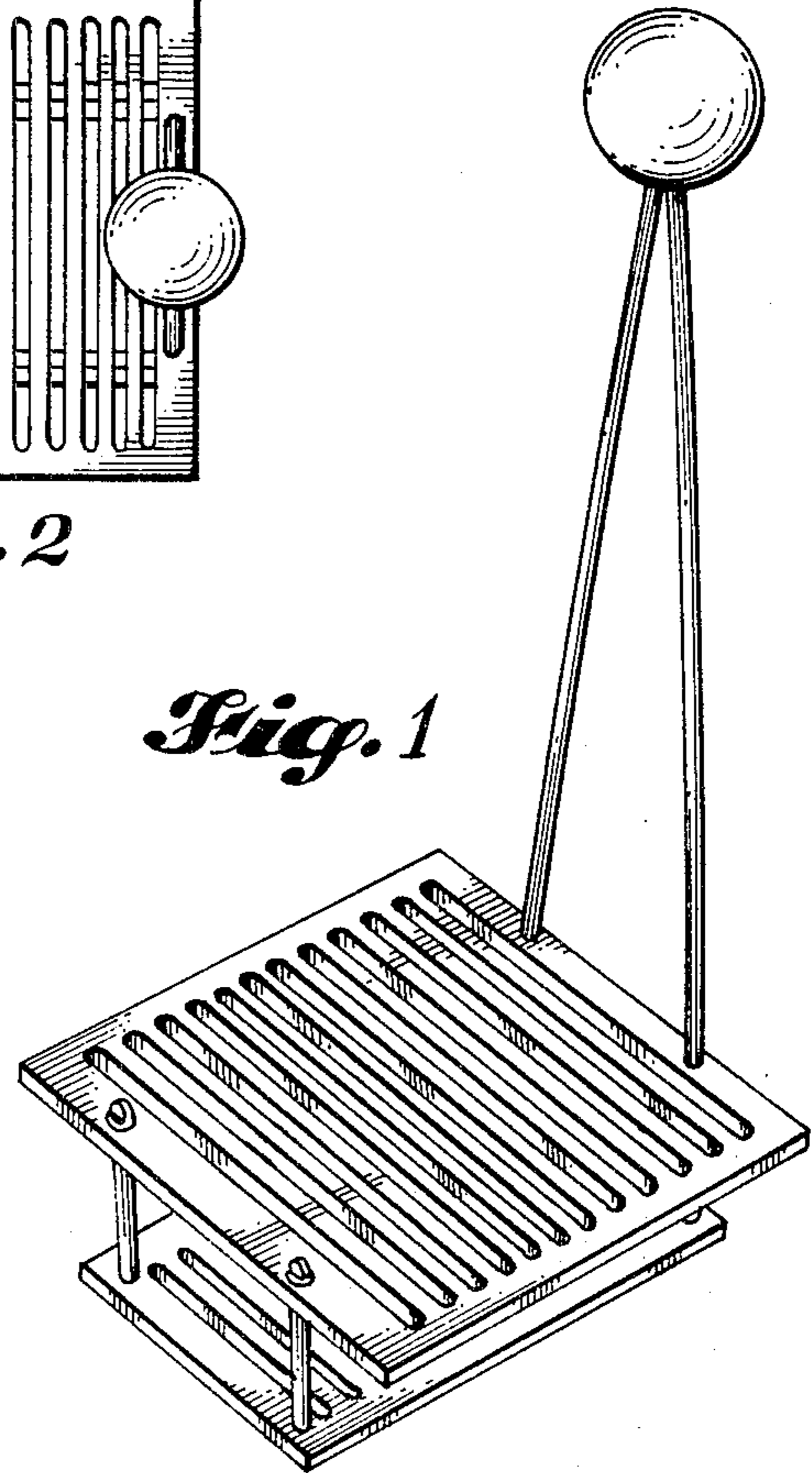

Fig. 1

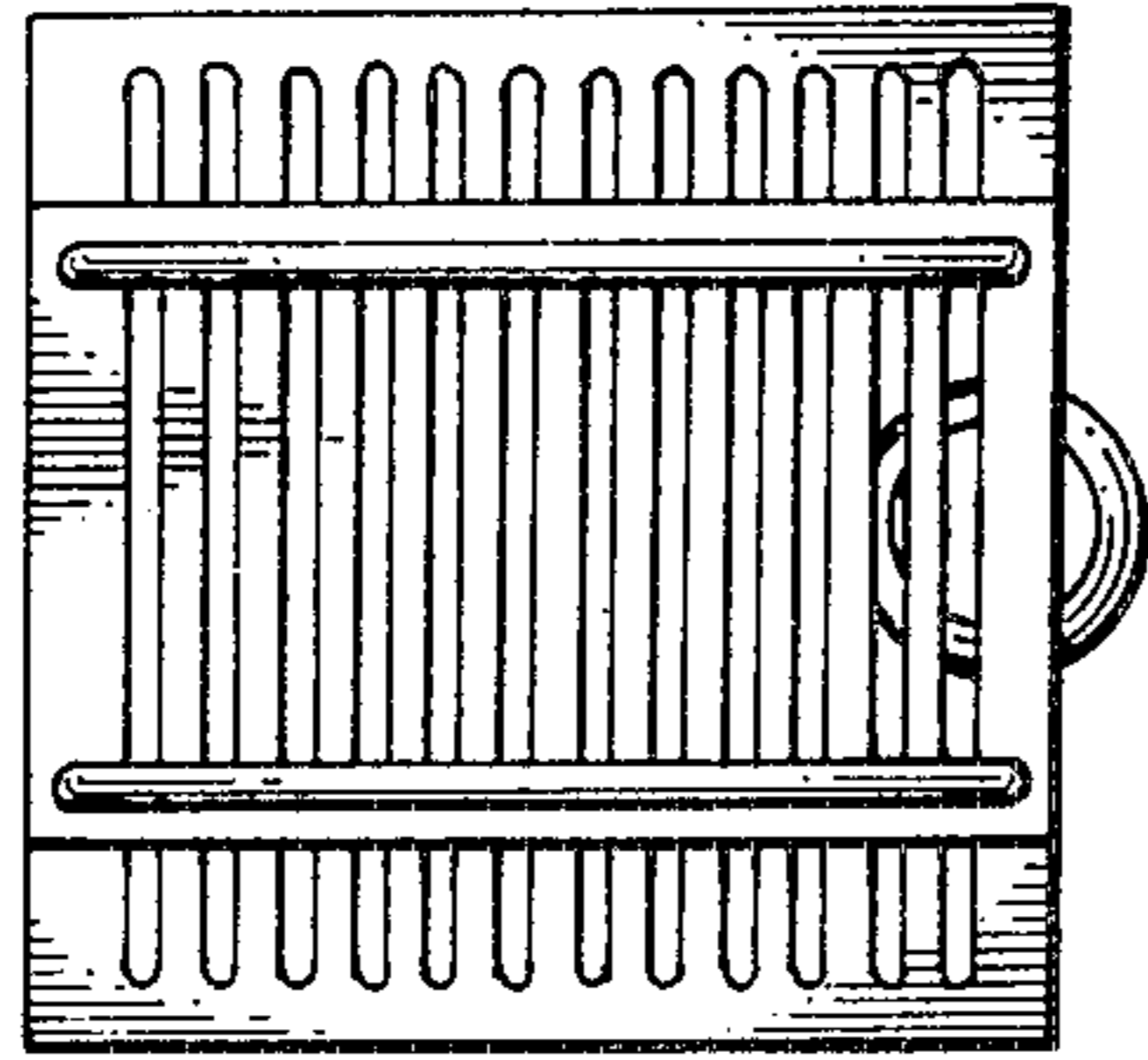

Fig. 3

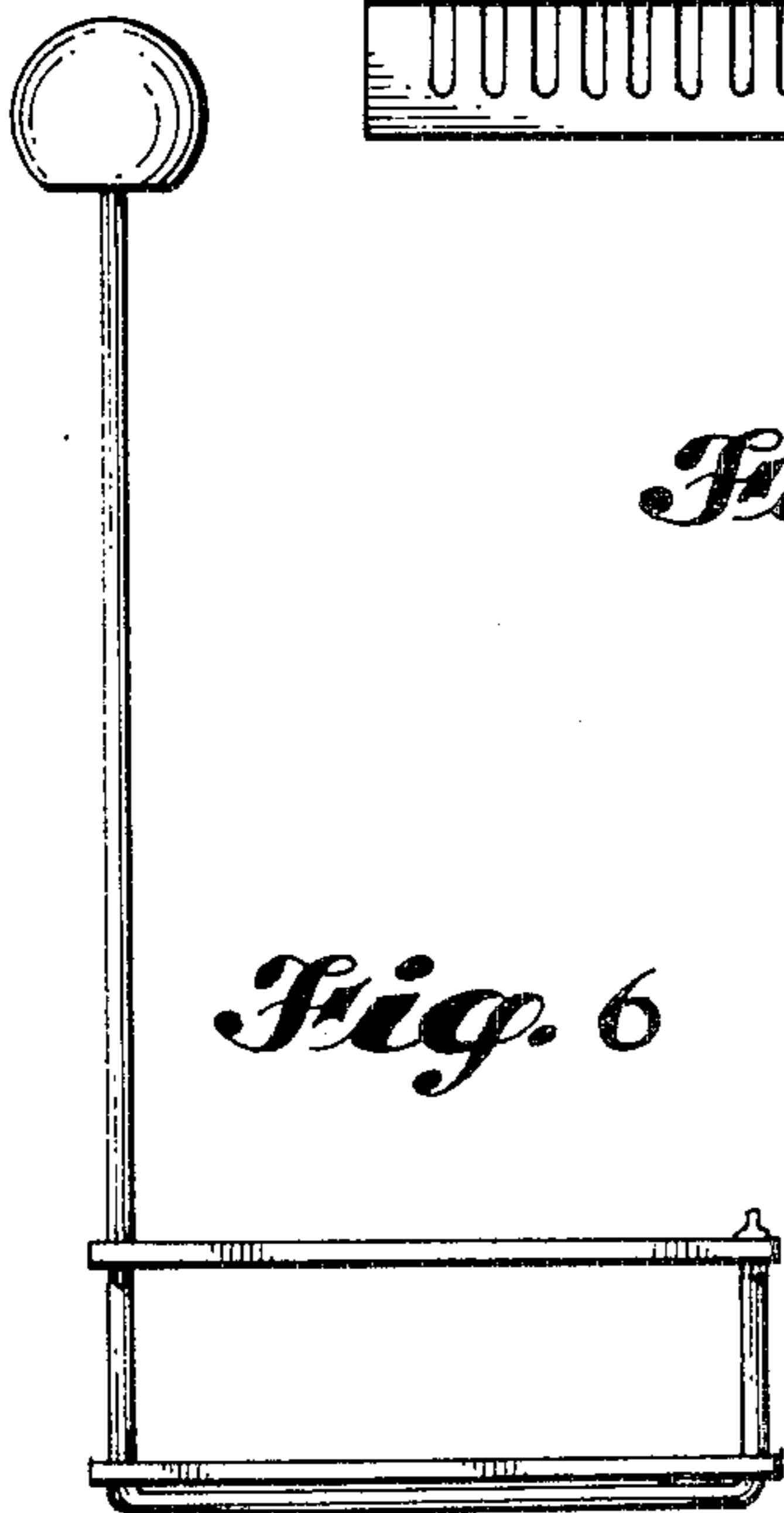

Fig. 6

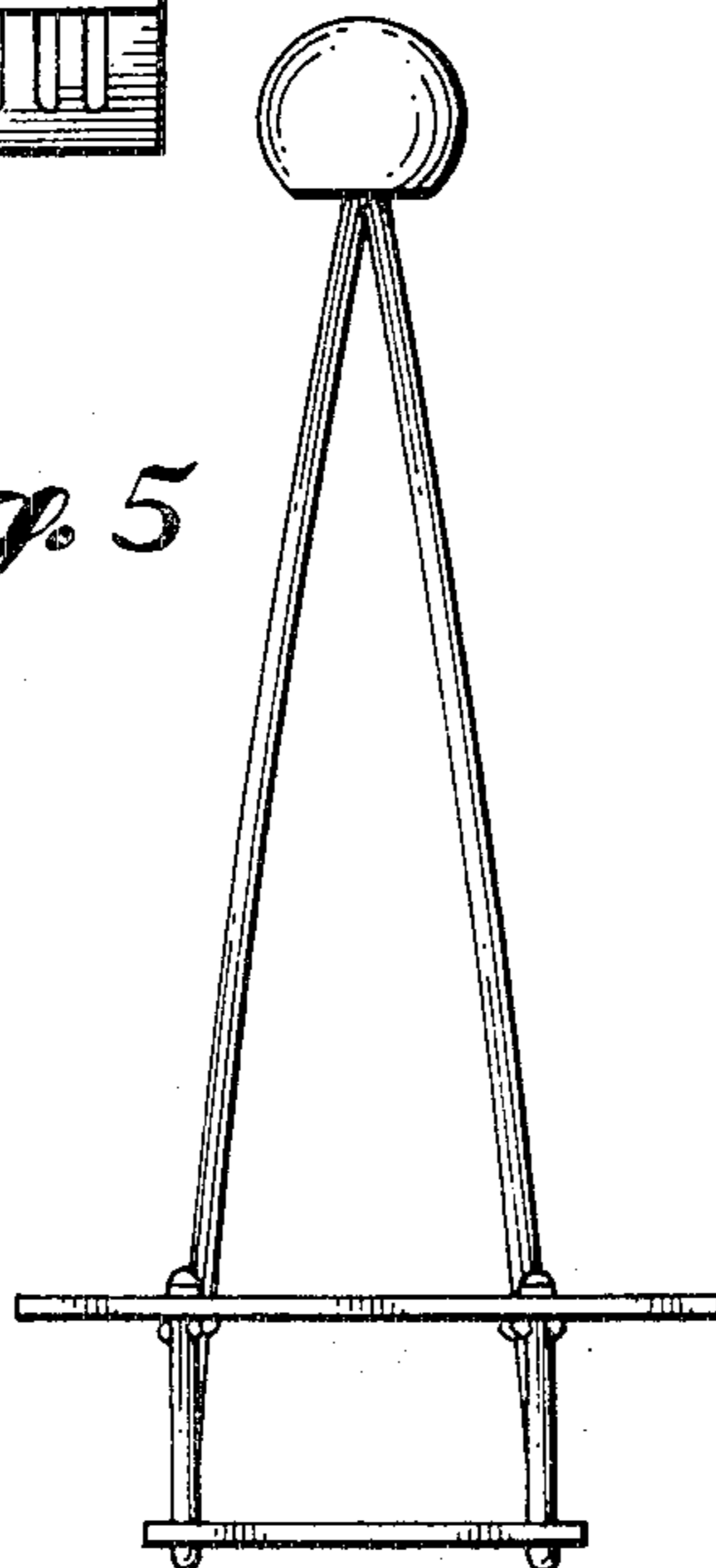

Fig. 5

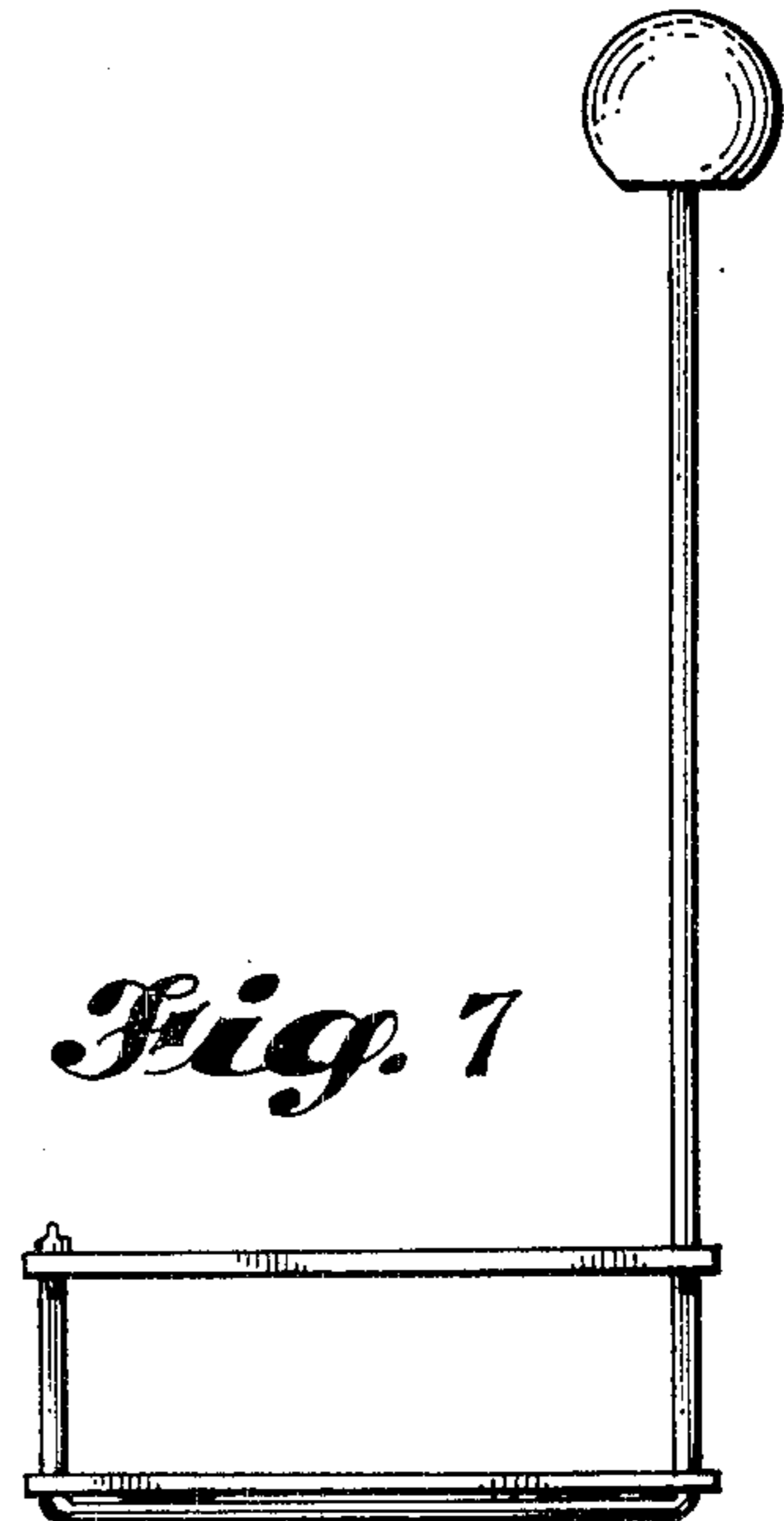

Fig. 7