

[54] COMBINED PAPER TOWEL HOLDER AND SHELF

[75] Inventor: Bruno Gecchelin, Milan, Italy

[73] Assignee: Fratelli Guzzini S.p.A., Recanati, Italy

[**] Term: 14 Years

[21] Appl. No.: 624,764

[22] Filed: Jun. 26, 1984

[30] Foreign Application Priority Data

Dec. 29, 1983 [IT] Italy 24058B/83
[52] U.S. Cl. D6/519; D6/522; D6/567; D6/574

[58] Field of Search D6/518, 519, 520, 521, D6/522, 523, 553, 567, 574; 206/233, 391, 394; 221/211, 45, 282; 242/55.2, 55.3, 55.42, 55.53, 55.54, 56 R, 56 B; 312/37, 38, 39, 40, 42, 242, 245; 225/106

[56] References Cited

U.S. PATENT DOCUMENTS

D. 217,187 4/1970 Ardis D6/522
D. 264,406 5/1982 Arnott D6/522
4,553,710 11/1985 Pool 242/55.53

FOREIGN PATENT DOCUMENTS

0259174 4/1967 Austria 242/55.53

OTHER PUBLICATIONS

Woodpecker Woodware, 2/1963, p D, #563-Cook Book Stand w/Paper Towel Holder, located in upper right corner.

Primary Examiner—Wallace R. Burke
Assistant Examiner—Suzanne N. Gitlin
Attorney, Agent, or Firm—Cushman, Darby & Cushman

[57] CLAIM

The ornamental design for a combined paper towel holder and shelf, as shown and described.

DESCRIPTION

FIG. 1 is a front perspective view of a combined paper towel holder and shelf showing my design; FIG. 2 is a front elevational view thereof; FIG. 3 is a reduced top plan view thereof; FIG. 4 is a reduced bottom plan view thereof; FIG. 5 is a reduced rear elevational view thereof; FIG. 6 is a reduced side elevational view taken from the left of FIG. 1; FIG. 7 is a reduced side elevational view taken from the right of FIG. 1.

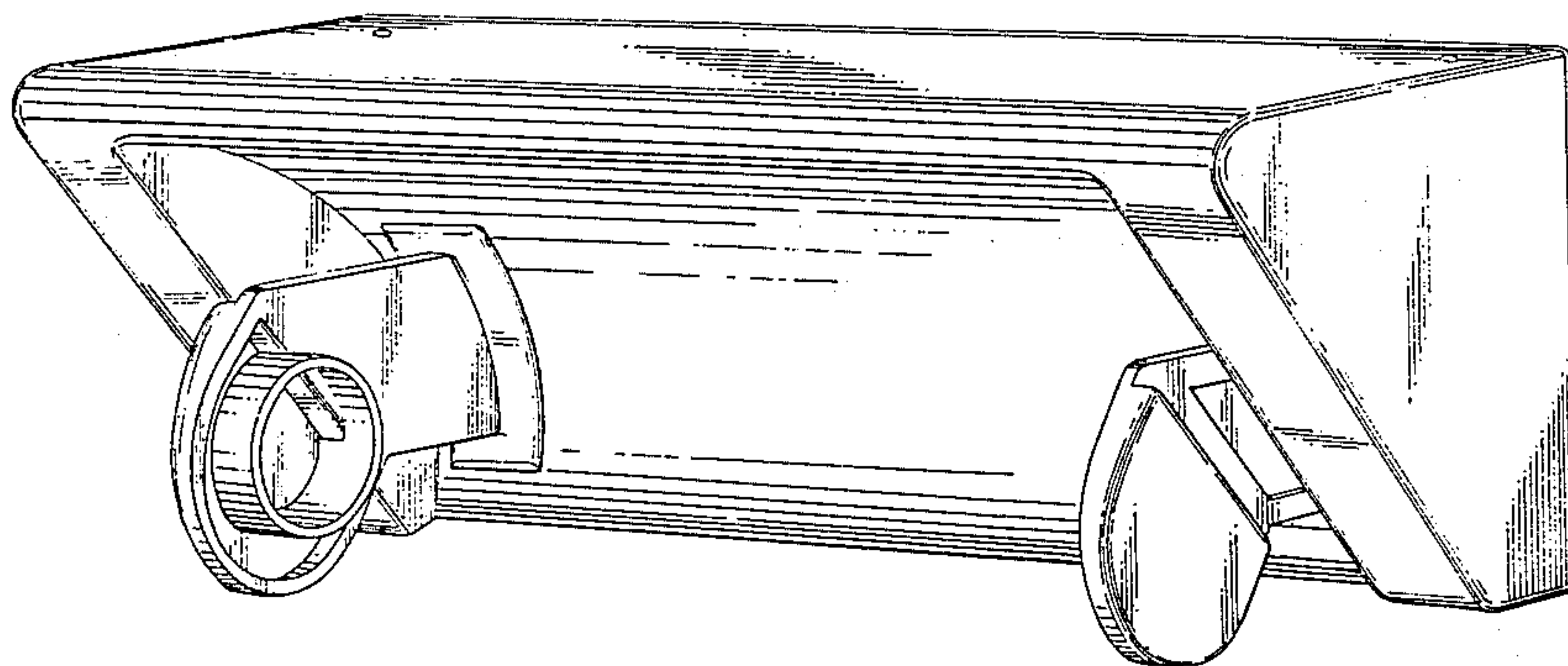

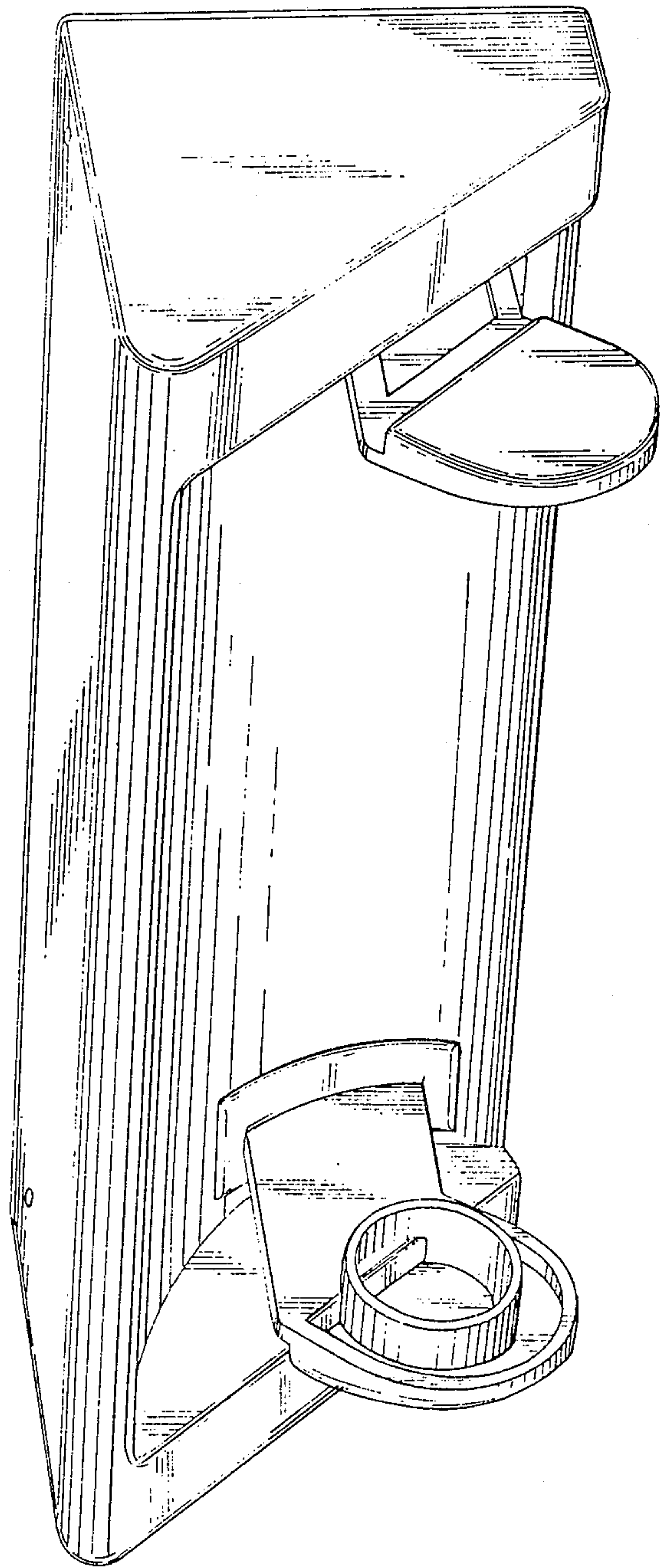

Fig. 1

Fig. 2

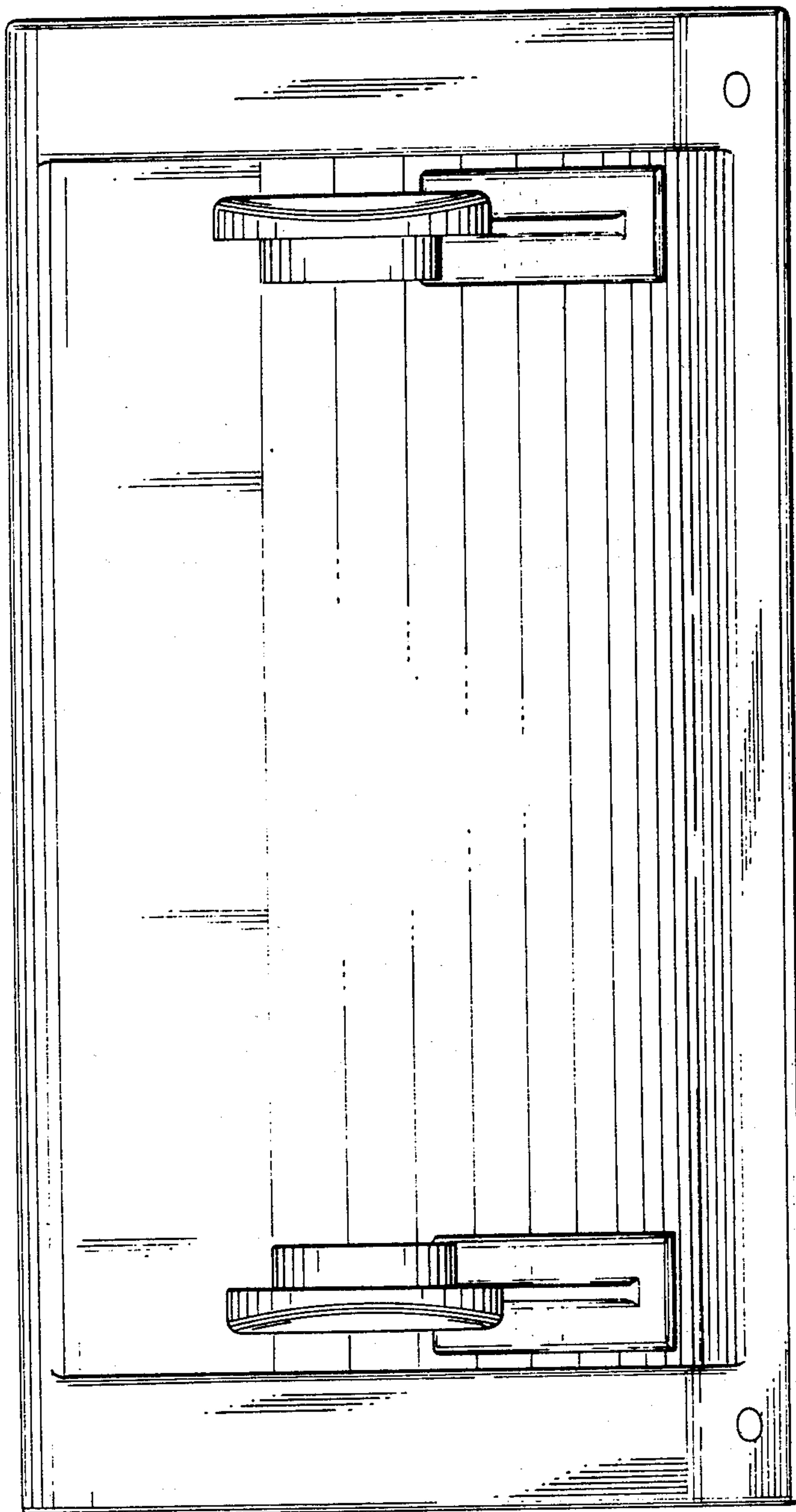

Fig. 3

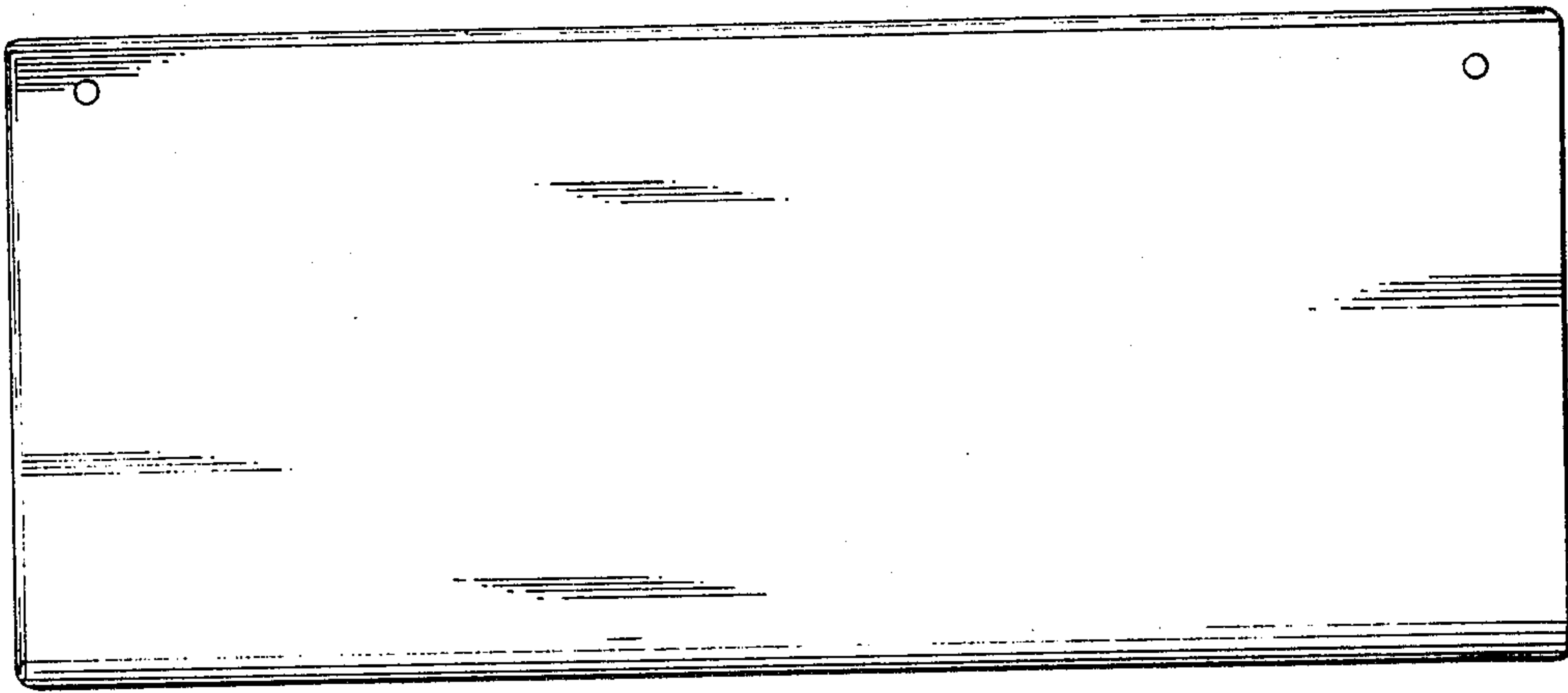

Fig. 4

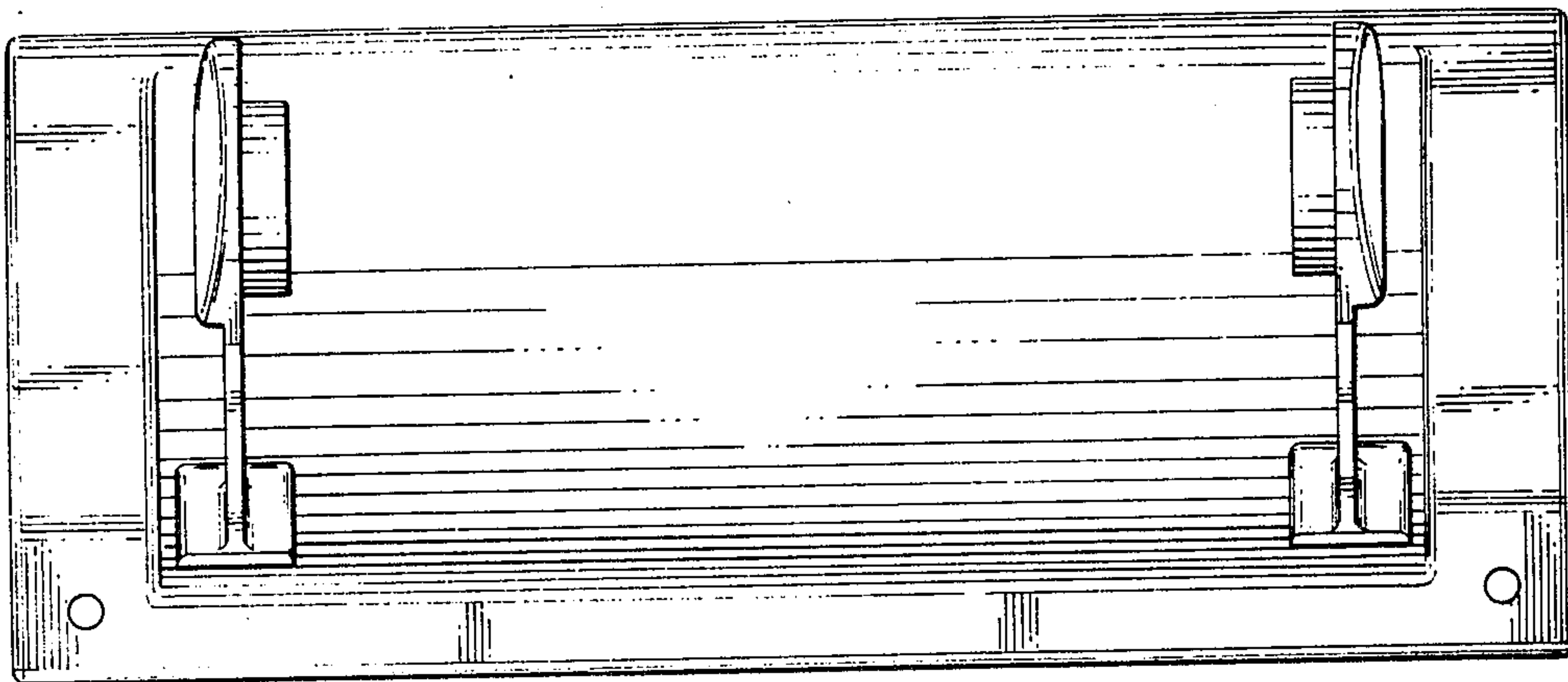

Fig. 5

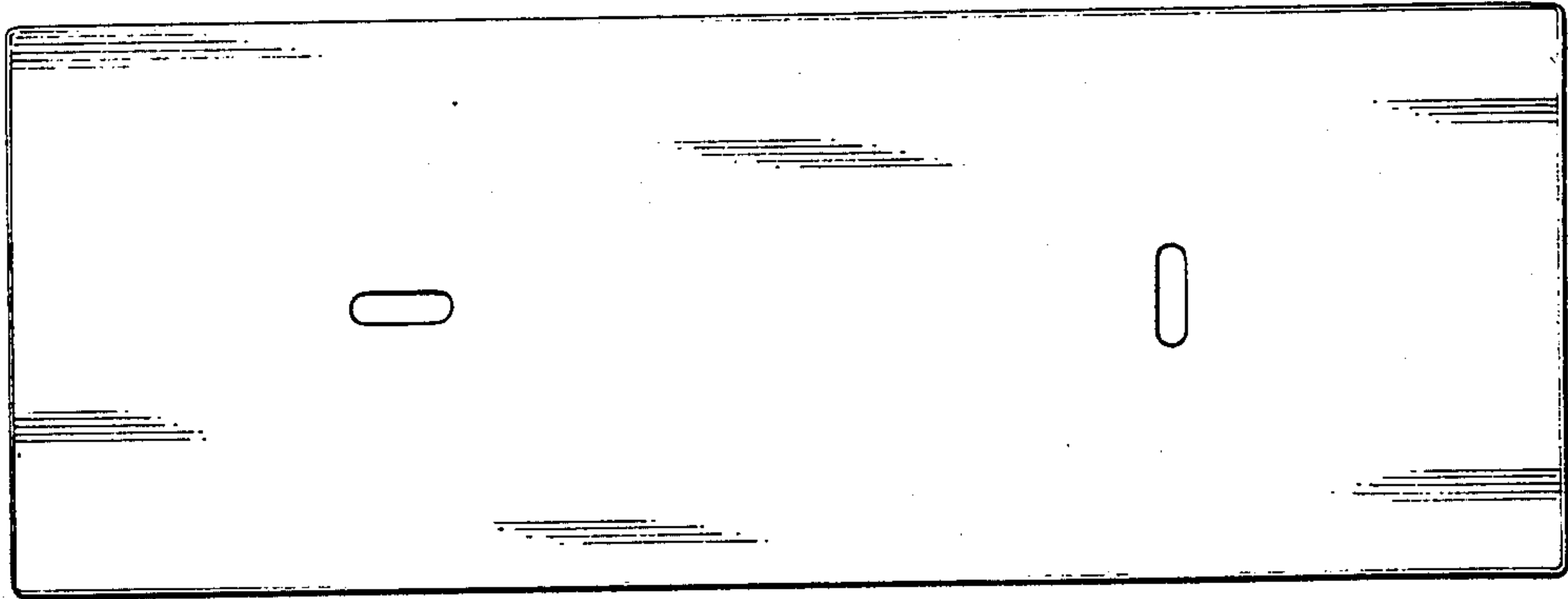

Fig. 6

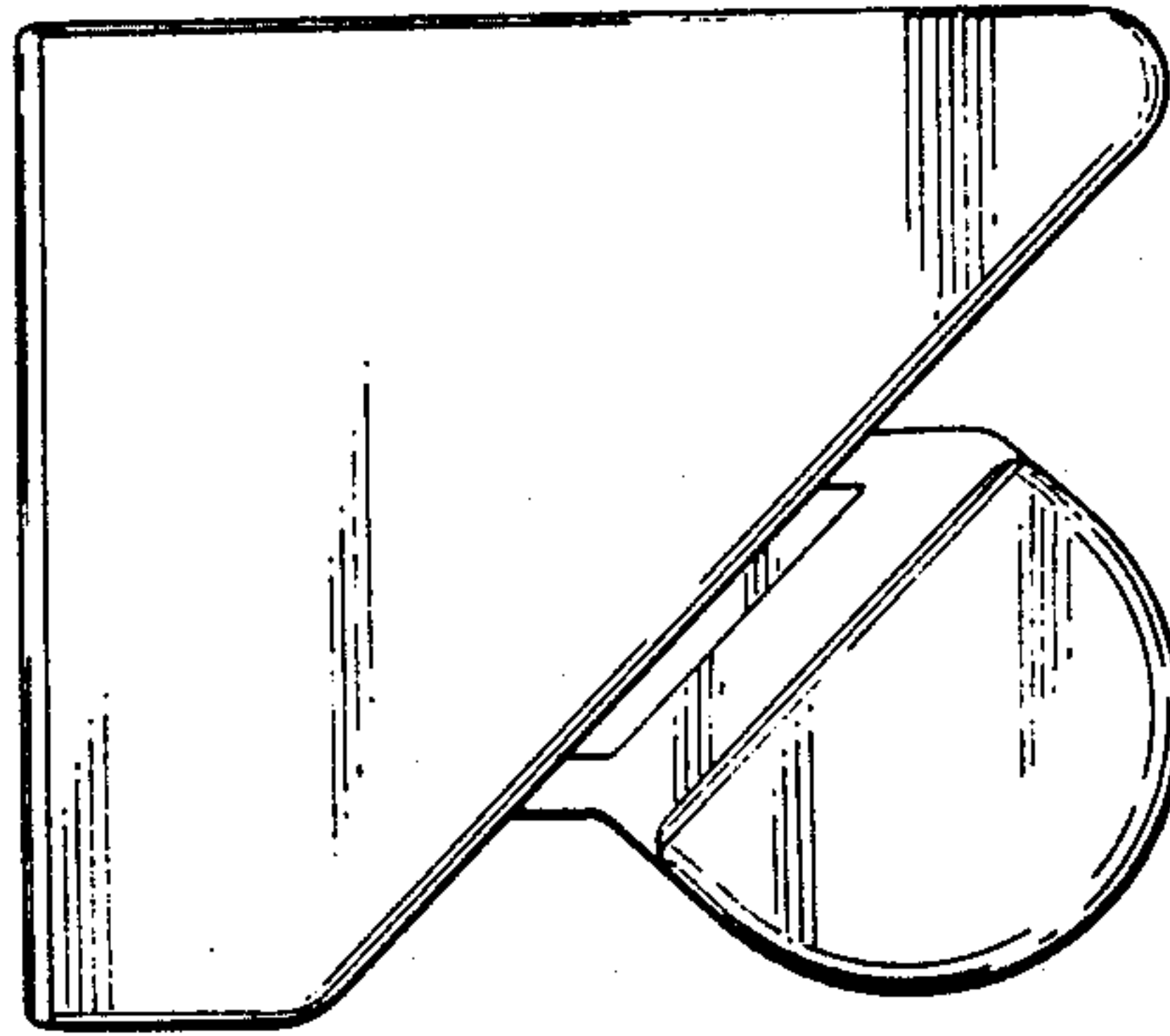

Fig. 7

