

[54] PRINTER HOUSING

[75] Inventors: Stephen Peart, Los Gatos; Mark F. Pruitt, Sunnyvale; William G. MacKenzie, San Jose, all of Calif.

[73] Assignee: Apple Computer, Inc., Cupertino, Calif.

[\*\*] Term: 14 Years

[21] Appl. No.: 602,597

[22] Filed: Apr. 20, 1984

[52] U.S. Cl. .... D14/111

[58] Field of Search ..... D14/100, 107, 111; D18/13, 22; 400/693

[56] References Cited

U.S. PATENT DOCUMENTS

- D. 264,083 4/1982 Grae ..... D14/111
- D. 276,725 12/1984 Izaki ..... D14/111

OTHER PUBLICATIONS

Epson MX Series Printers Brochure ©1982, front cover, right side, Printer (Computer Box).

The Office, 9-1981, p. 224, Centronics Dot Matrix Printer (Computer Box).

Radio Shack 1983 TRS-80 Microcomputer Catalog #RSC-8, ©1982, p. 21, 15" wide Printer (Computer Box).

Primary Examiner—Susan J. Lucas

Attorney, Agent, or Firm—Blakely, Sokoloff, Taylor & Zafman

[57] CLAIM

The ornamental design for a printer housing, substantially as shown.

DESCRIPTION

FIG. 1 is a perspective view of a printer housing showing our new design;

FIG. 2 is a top plan view thereof;

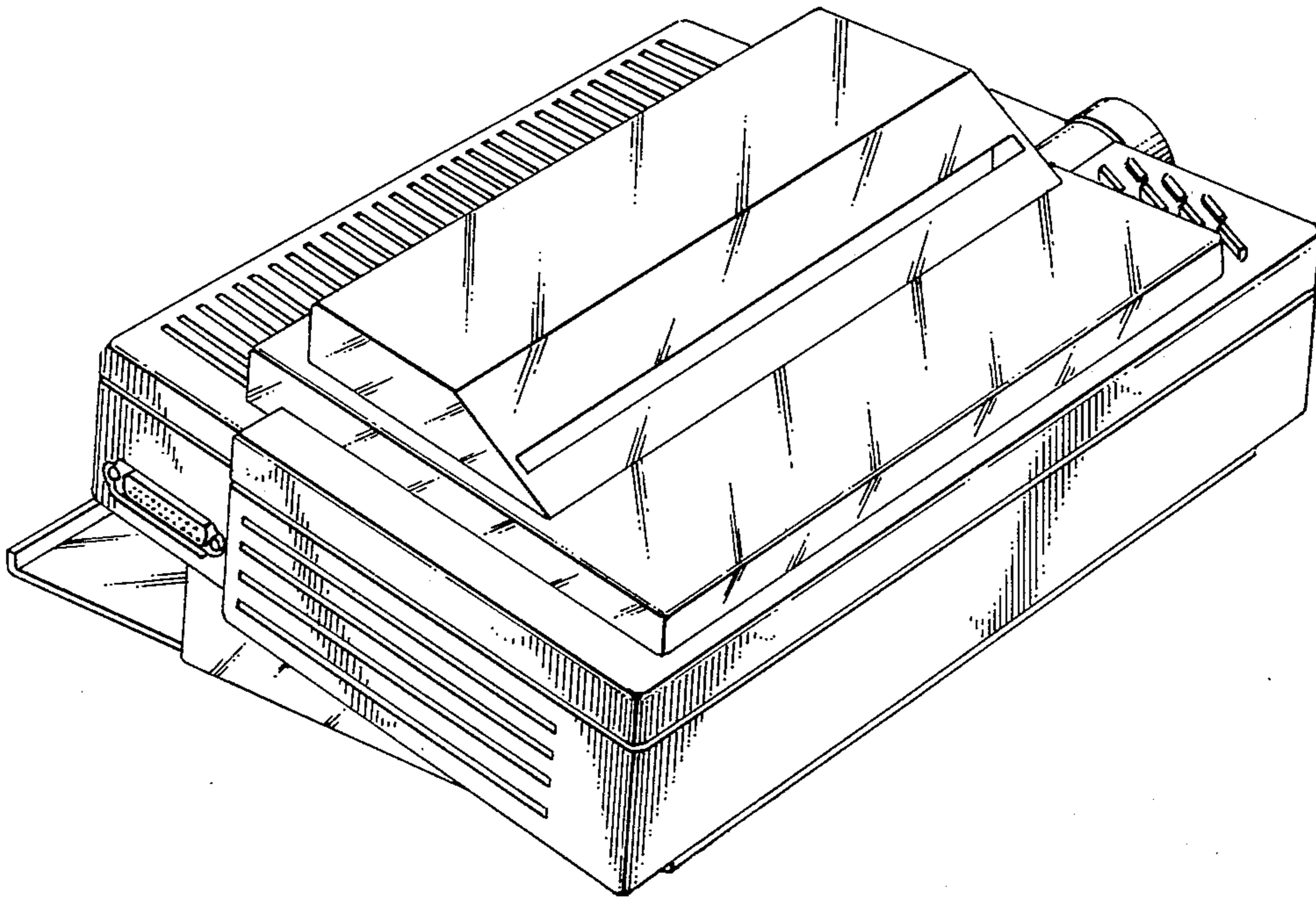
FIG. 3 is a front elevational view thereof;

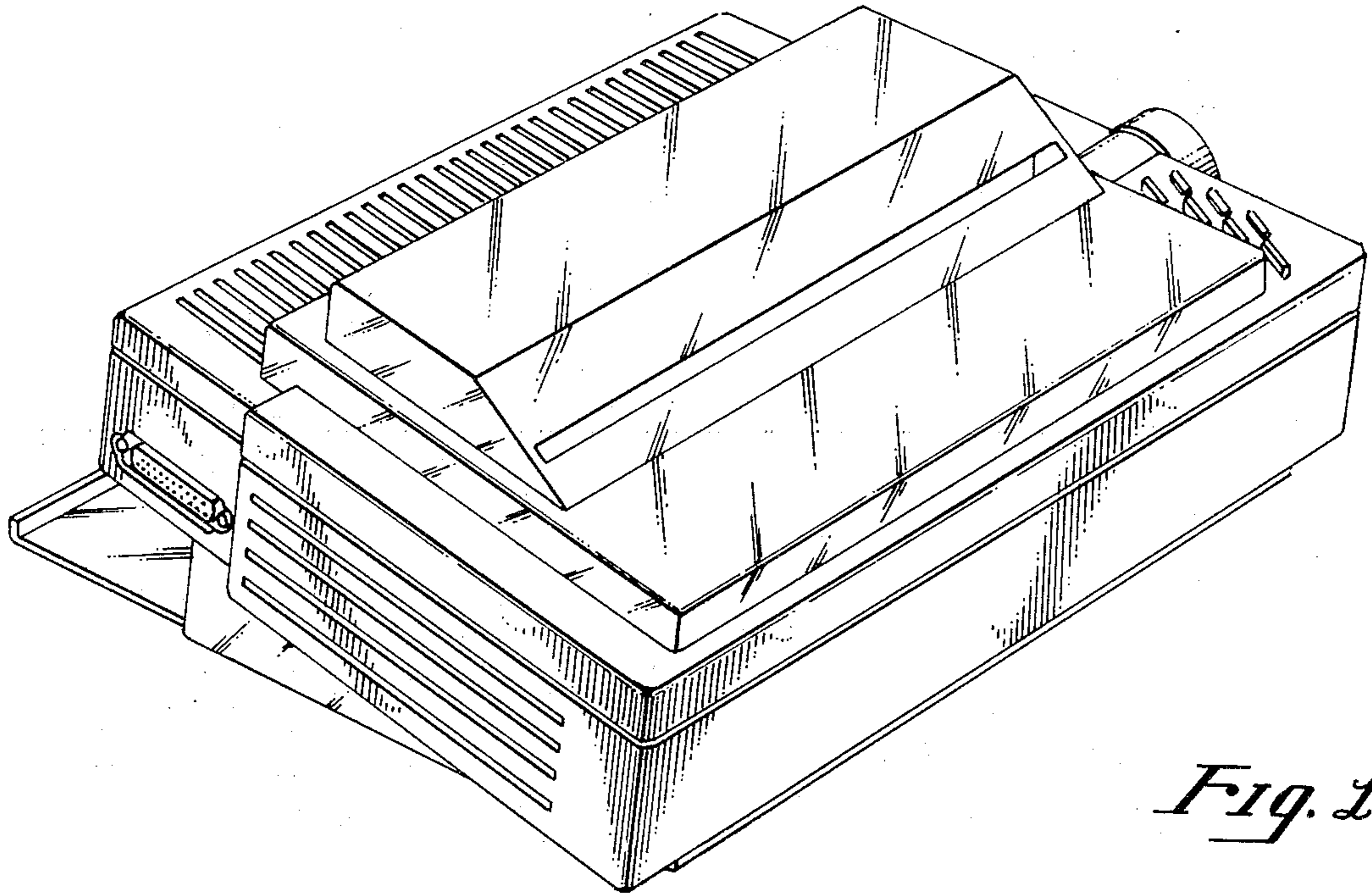
FIG. 4 is a right side elevational view thereof;

FIG. 5 is a left side elevational view thereof;

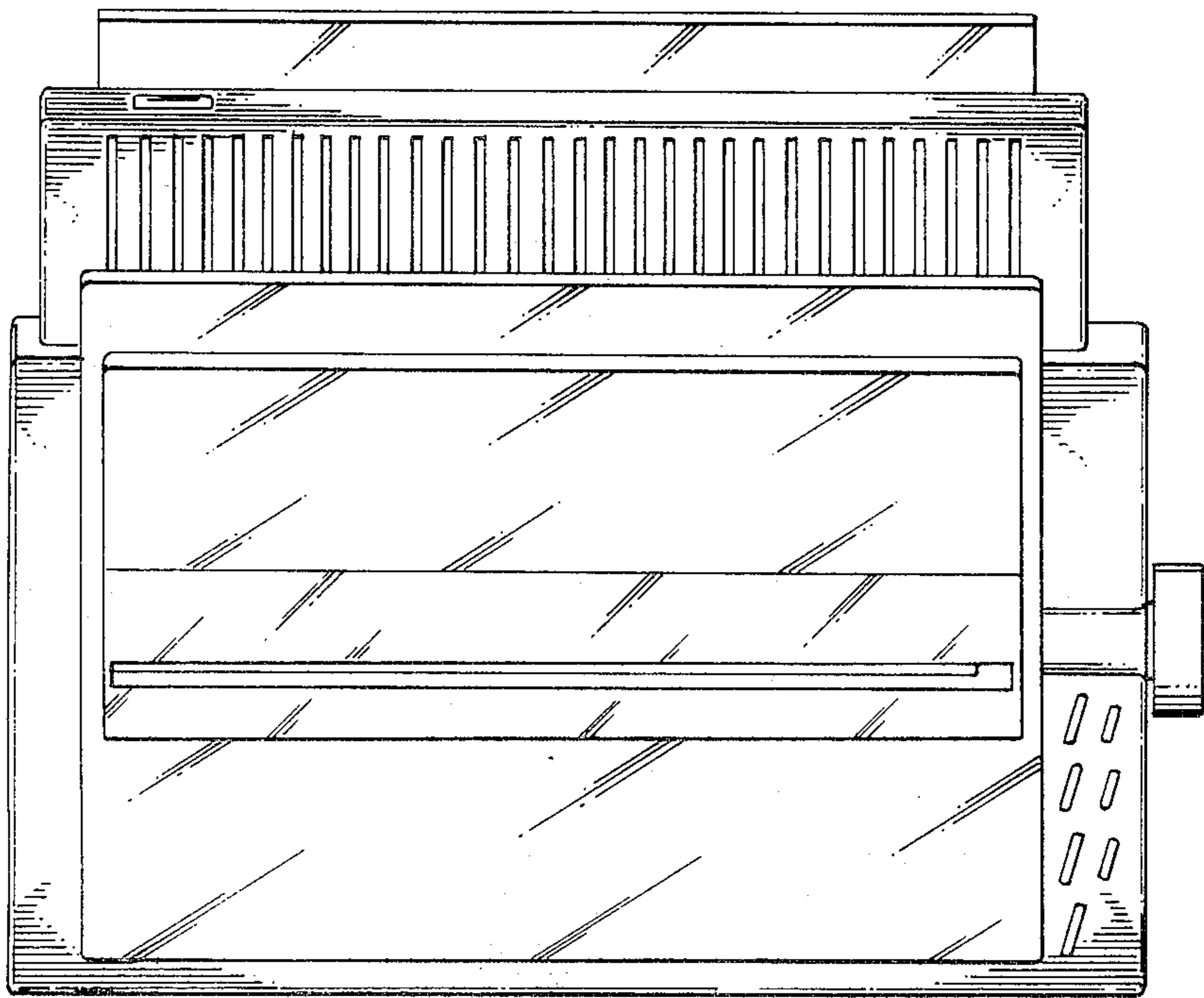
FIG. 6 is a rear elevational view thereof;

FIG. 7 is a bottom plan view thereof.

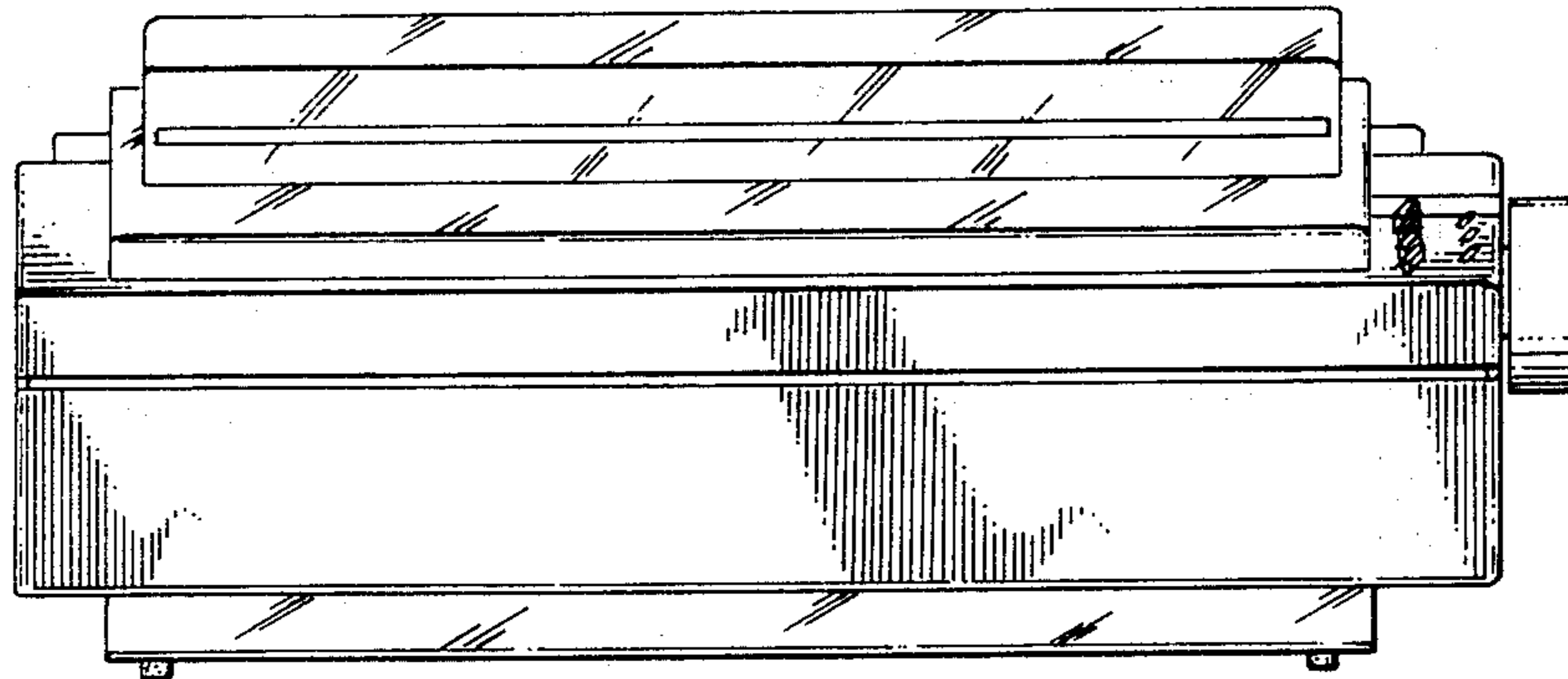




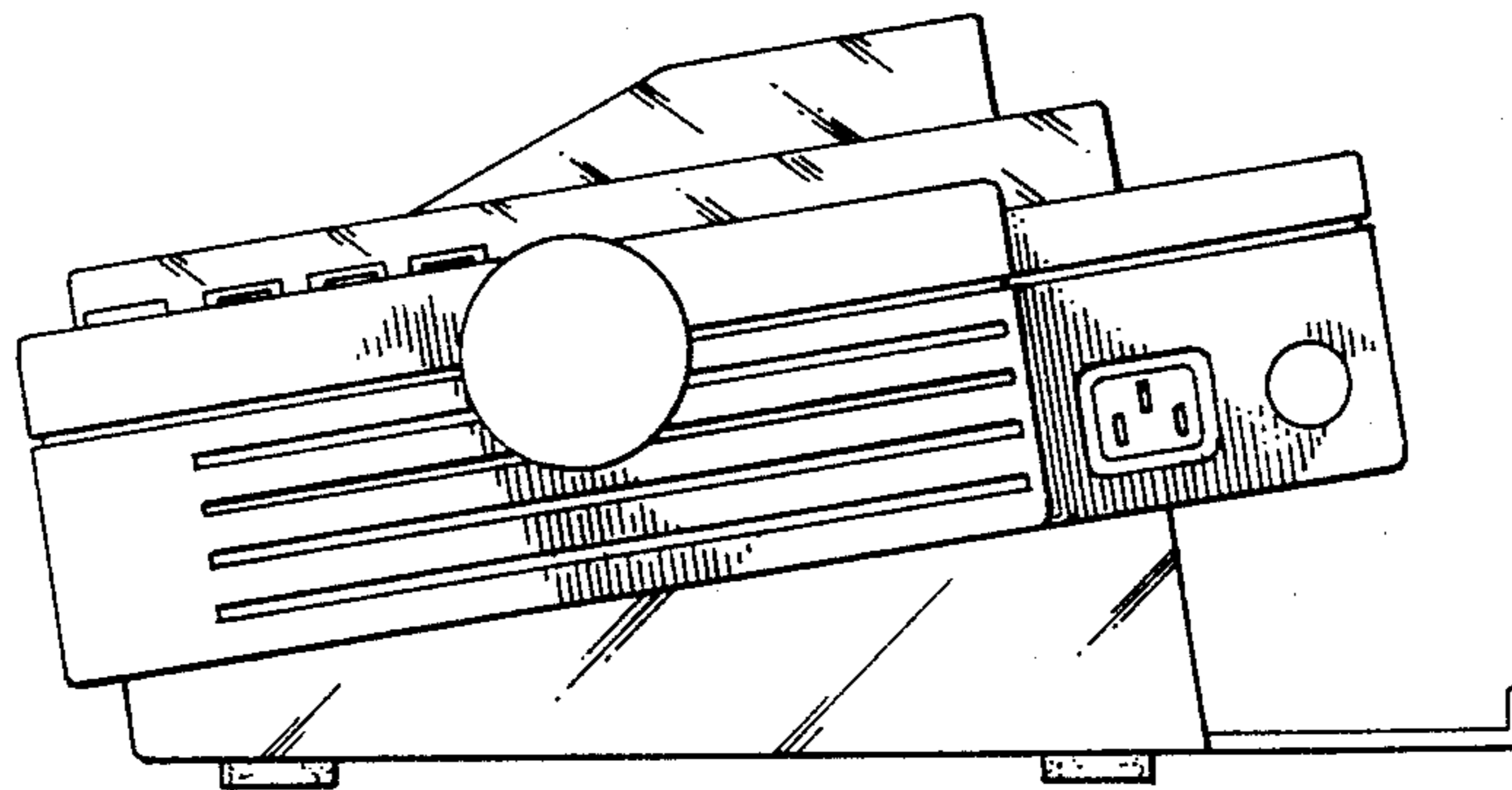
*Fig. 1*



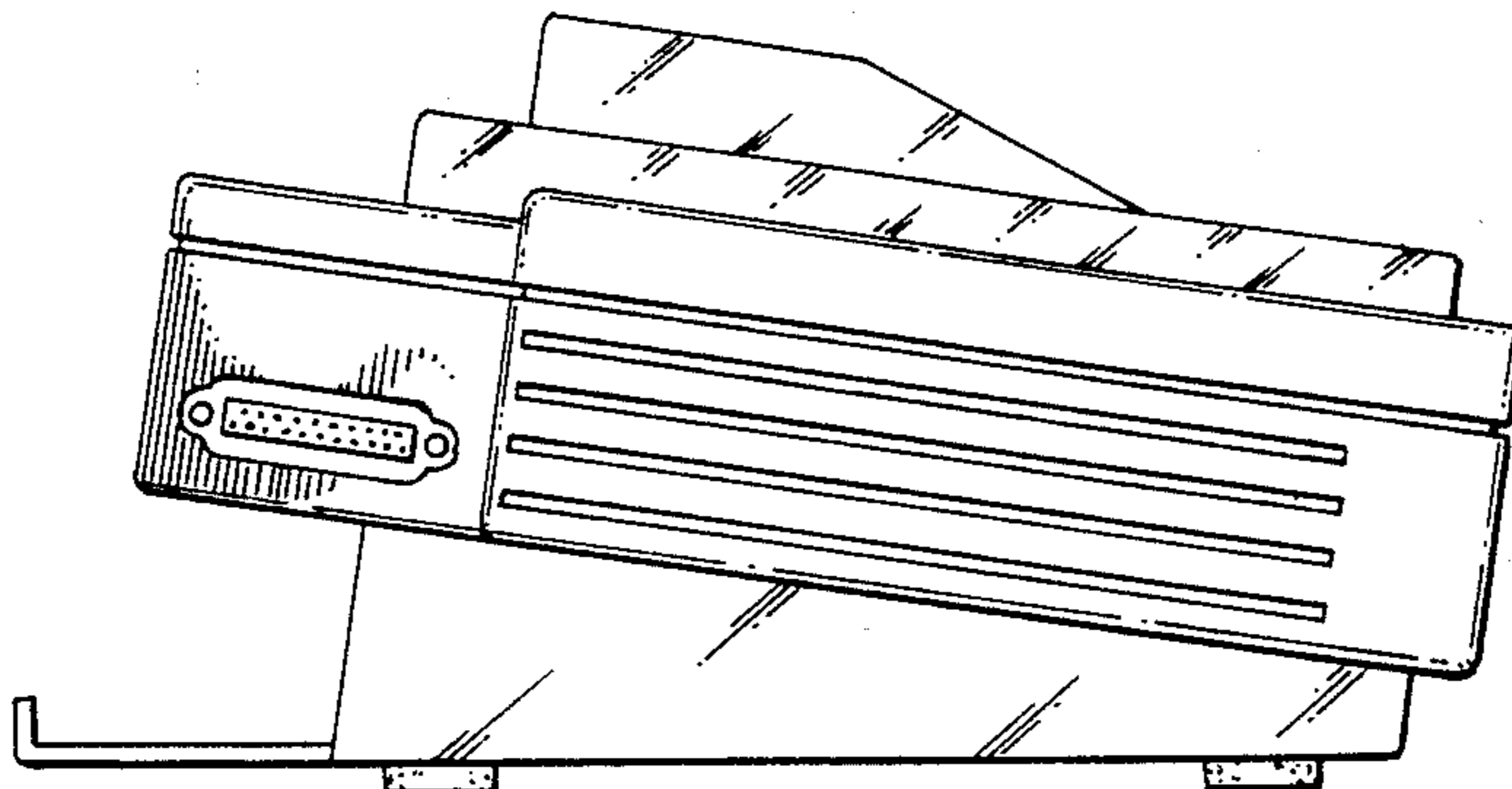
*Fig. 2*



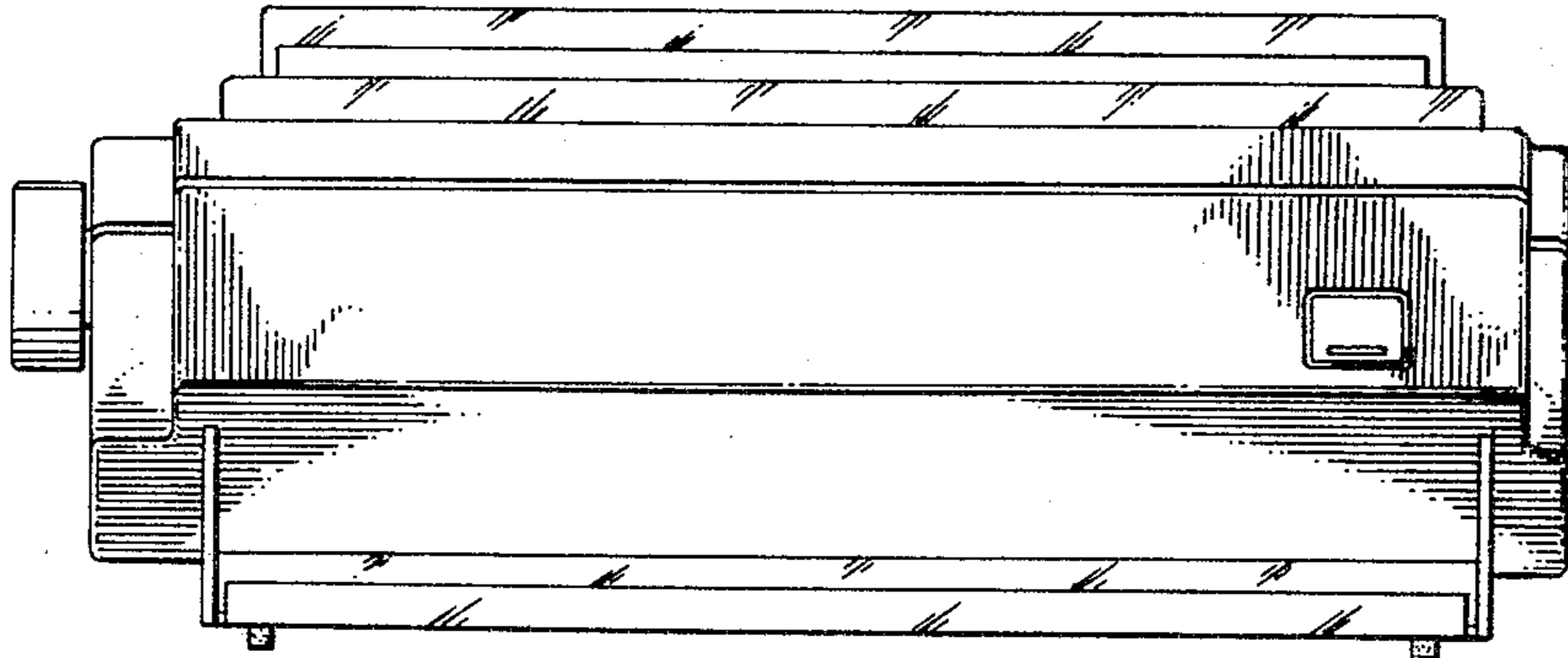
*Fig. 3*



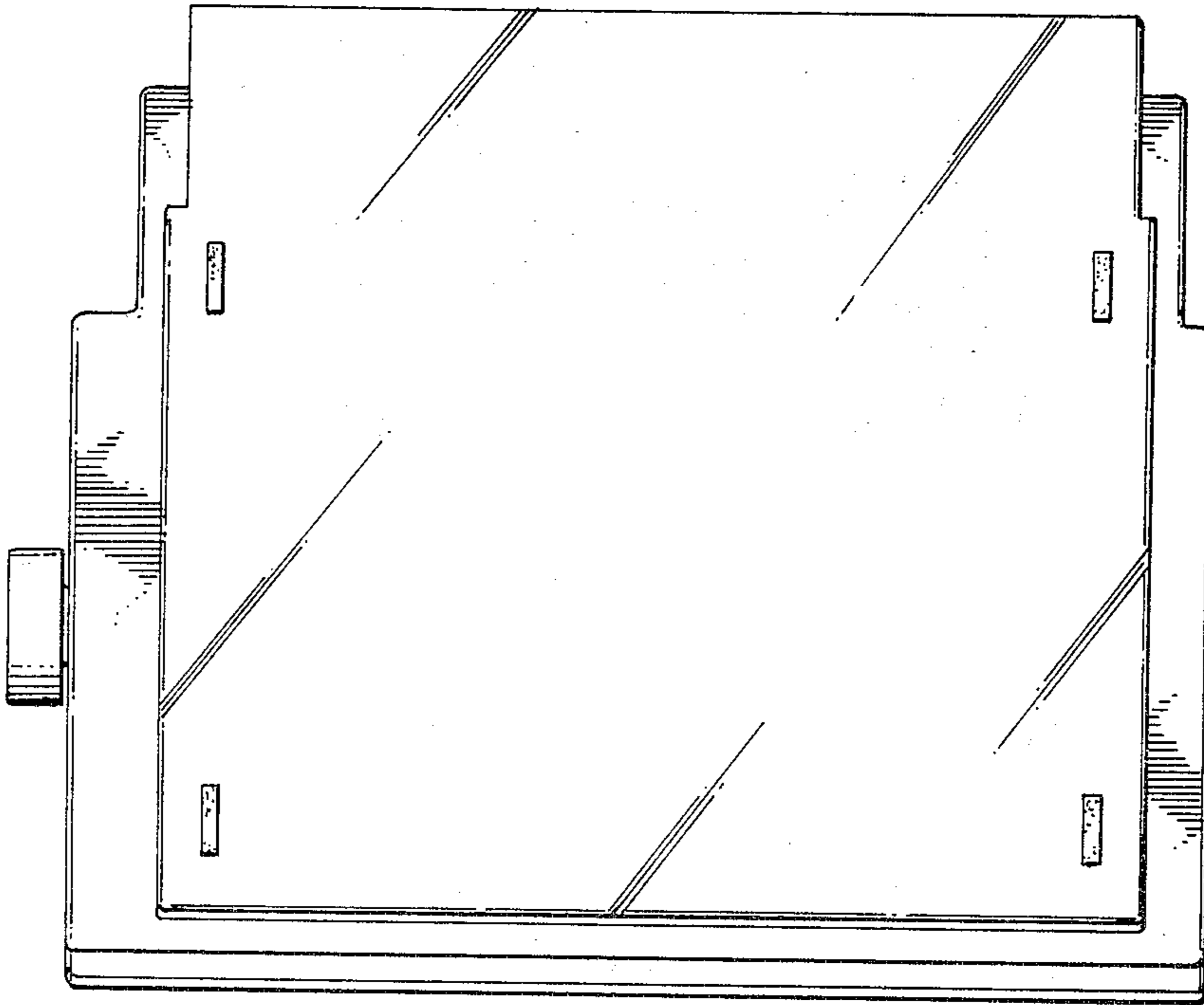
*Fig. 4*



*Fig. 5*



*Fig. 6*



*Fig. 7*