

[54] VENTILATOR FOR CARGO CONTAINER

[75] Inventor: Paul E. Morgan, Bridgewater, N.J.

[73] Assignee: CTI International, White Plains, N.J.

[*] Notice: The portion of the term of this patent subsequent to Jun. 10, 2000 has been disclaimed.

[**] Term: 14 Years

[21] Appl. No.: 603,160

[22] Filed: Apr. 23, 1984

[52] U.S. Cl. D23/151

[58] Field of Search D23/139-143, D23/151-155, 92, 83, 111-119; 62/239, 241-244, 263; D12/93-96; 296/15, 91; 98/2, 2.11, 2.14, 2.16-2.17, 35-39, 42, 42.21, 94.1-94.2, 114, 115.1-115.4

[56] References Cited

U.S. PATENT DOCUMENTS

| | | | |
|------------|---------|----------------------|---------|
| D. 209,581 | 12/1967 | Noyes et al. | D23/142 |
| D. 247,508 | 3/1978 | Kujawa, Jr. | D23/140 |
| D. 250,661 | 12/1978 | Anderson et al. | D23/142 |
| 3,848,428 | 11/1974 | Rieter, Jr. | 62/239 |
| 4,201,064 | 5/1980 | Krug et al. | 62/239 |
| 4,365,484 | 12/1982 | Carson et al. | 62/263 |

Primary Examiner—Wallace R. Burke
Assistant Examiner—Brian N. Vinson
Attorney, Agent, or Firm—Charles E. Baxley

[57] CLAIM

The ornamental design for a ventilator for cargo container, as shown and described.

DESCRIPTION

FIG. 1 is a top perspective view of a ventilator for a cargo container showing my new design; FIG. 2 is a bottom perspective view thereof; FIG. 3 is a top plan view thereof; FIG. 4 is an end elevational view thereof; FIG. 5 is a bottom plan view thereof; and FIG. 6 is an opposite end elevational view thereof.

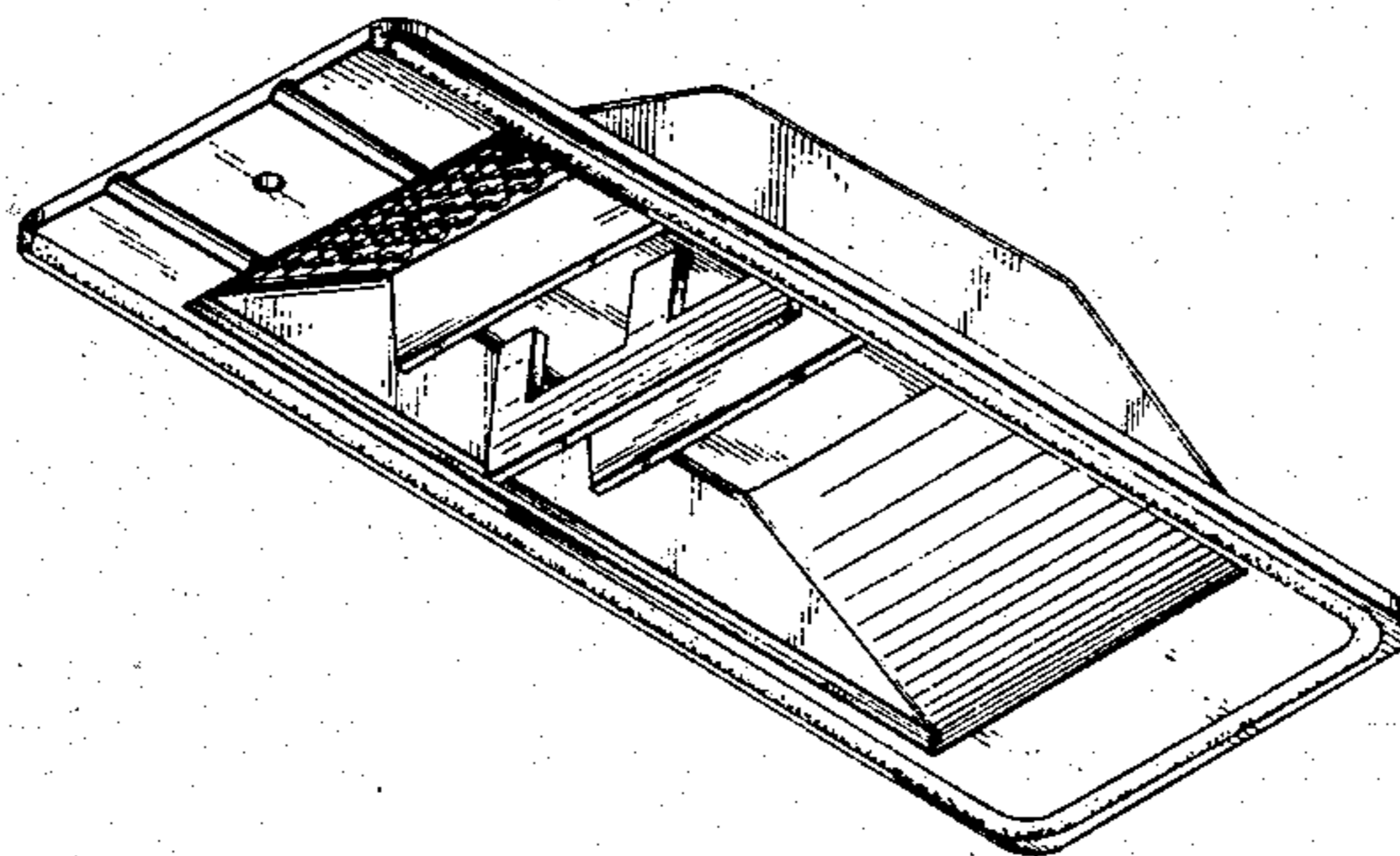
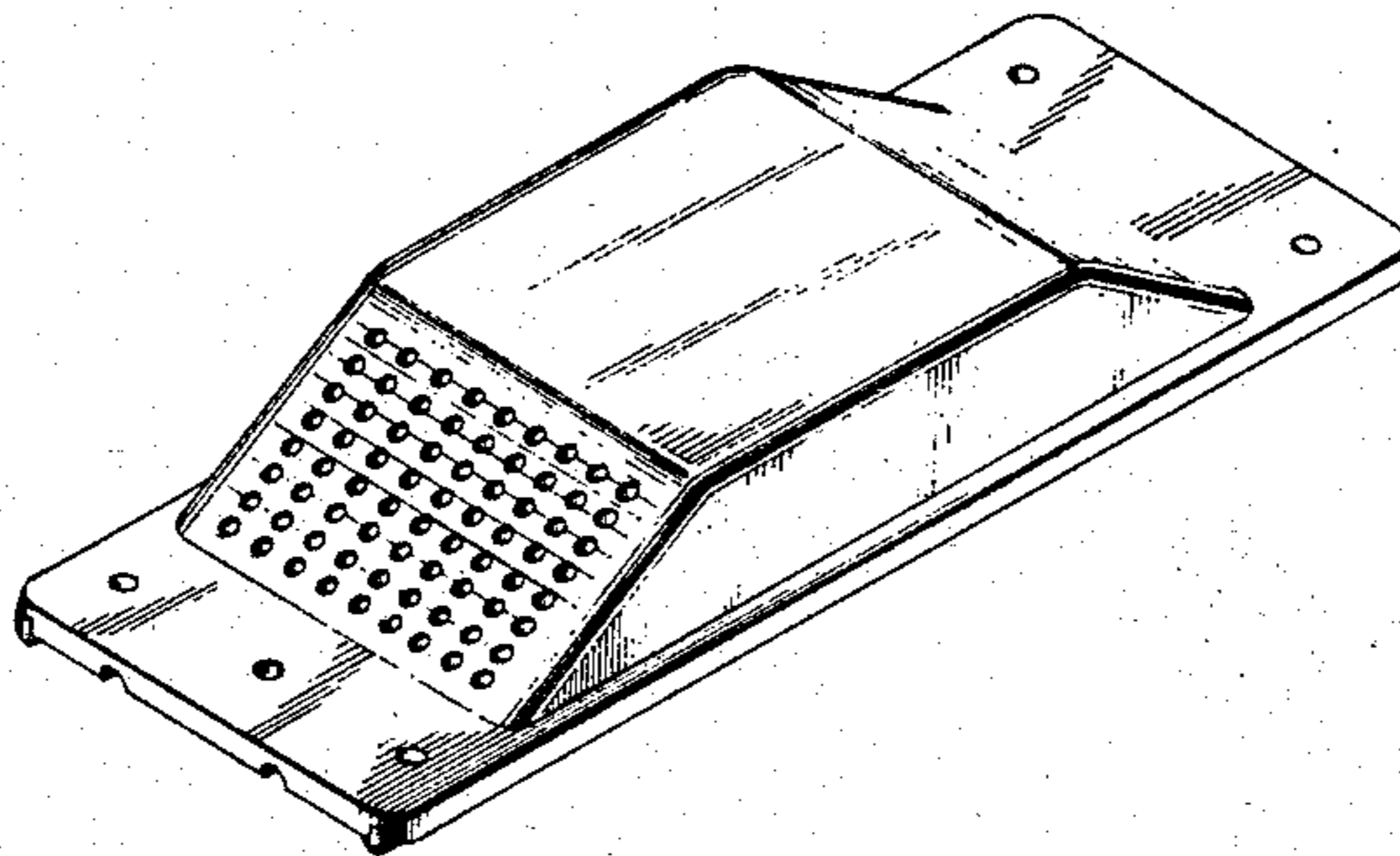

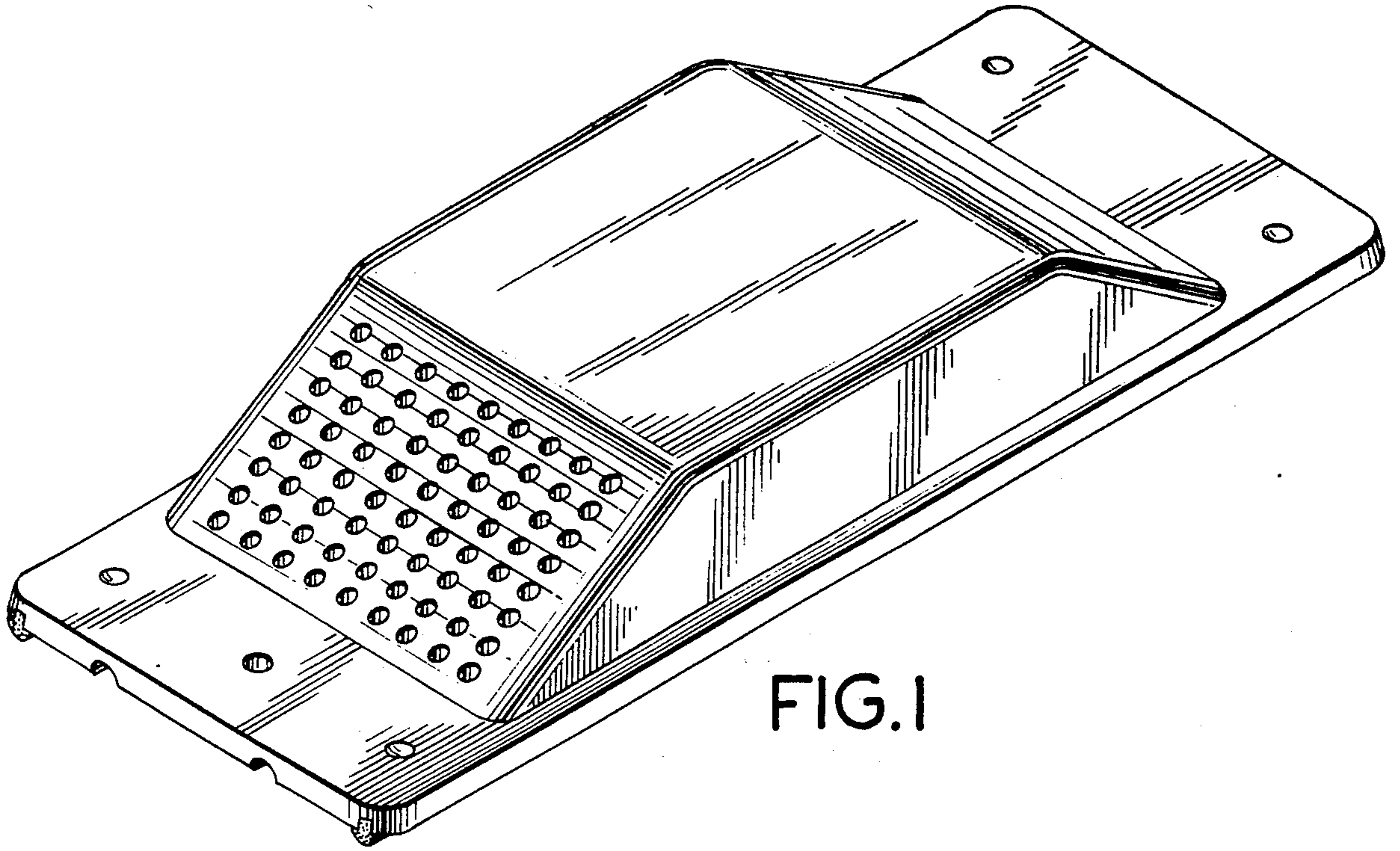

FIG. 1

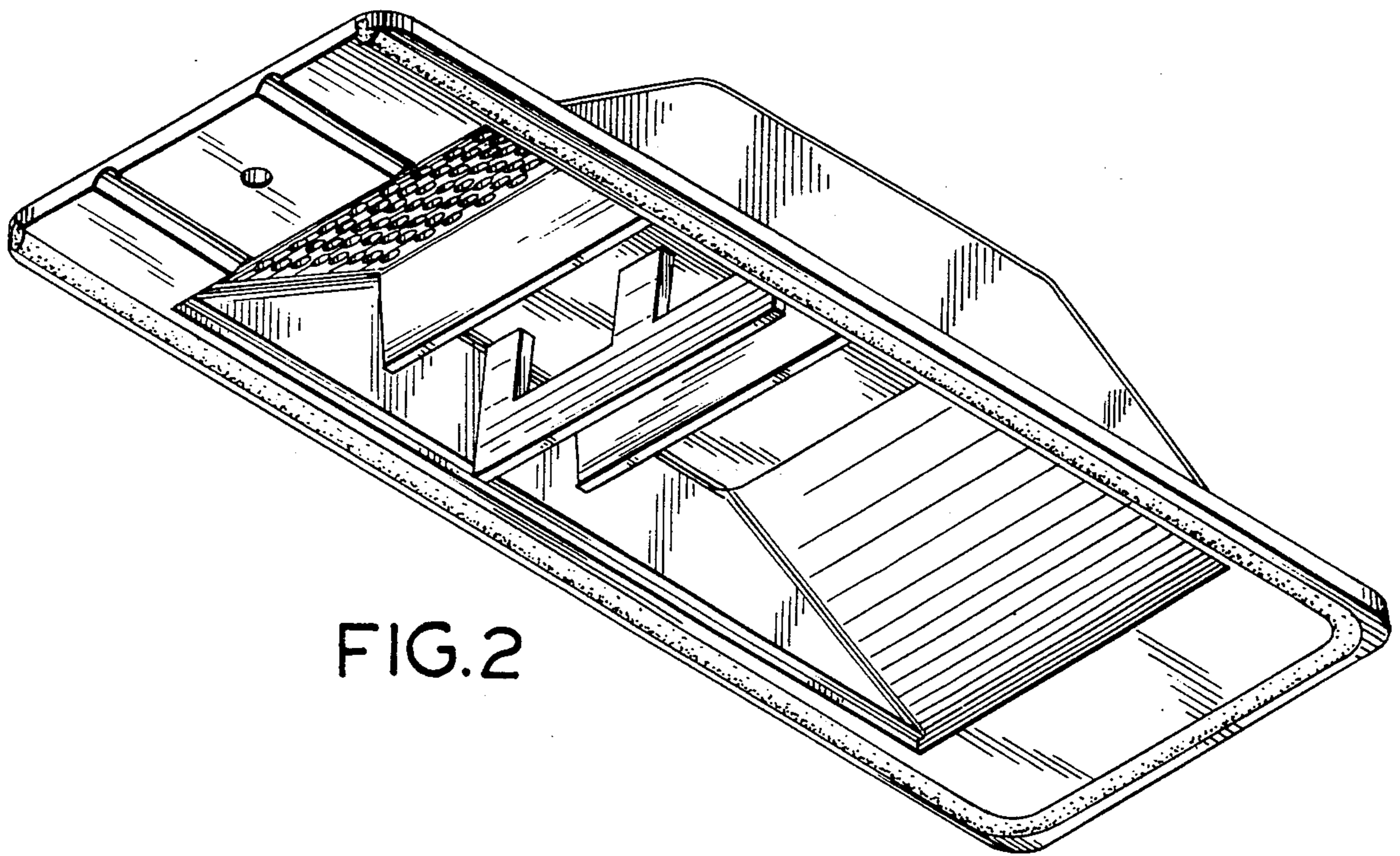

FIG. 2

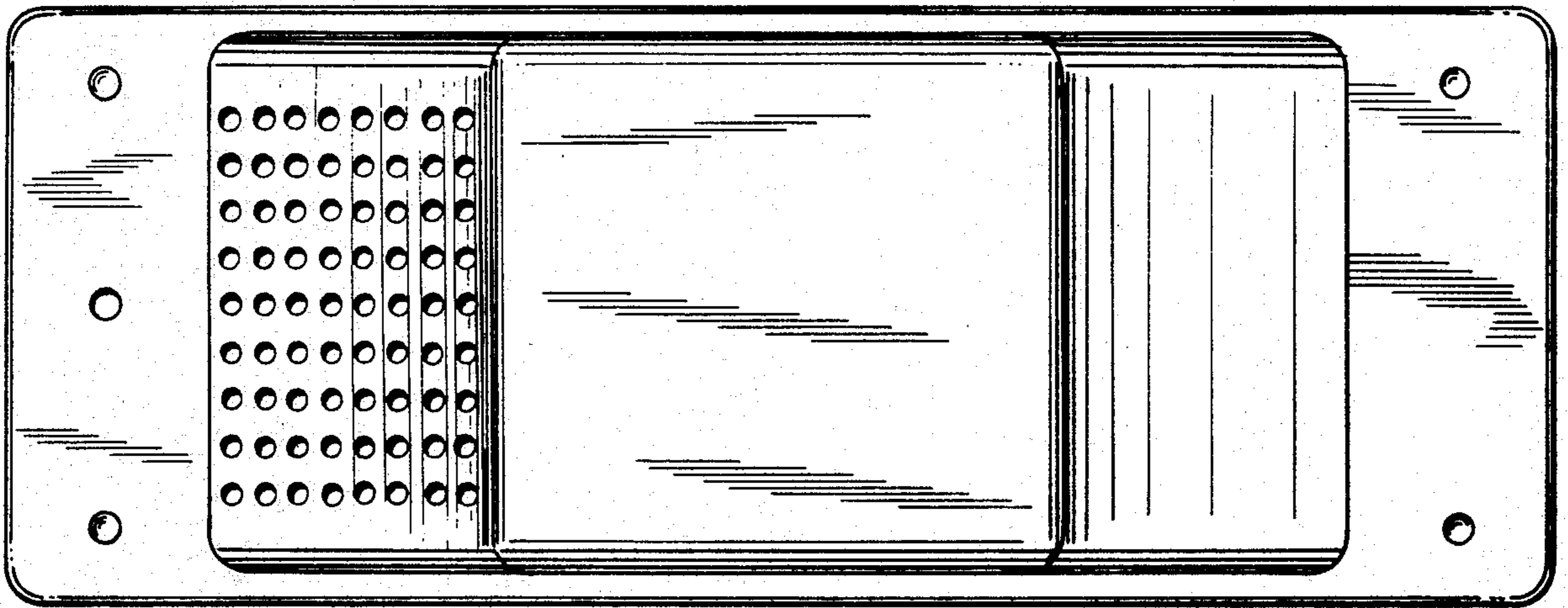

FIG. 3

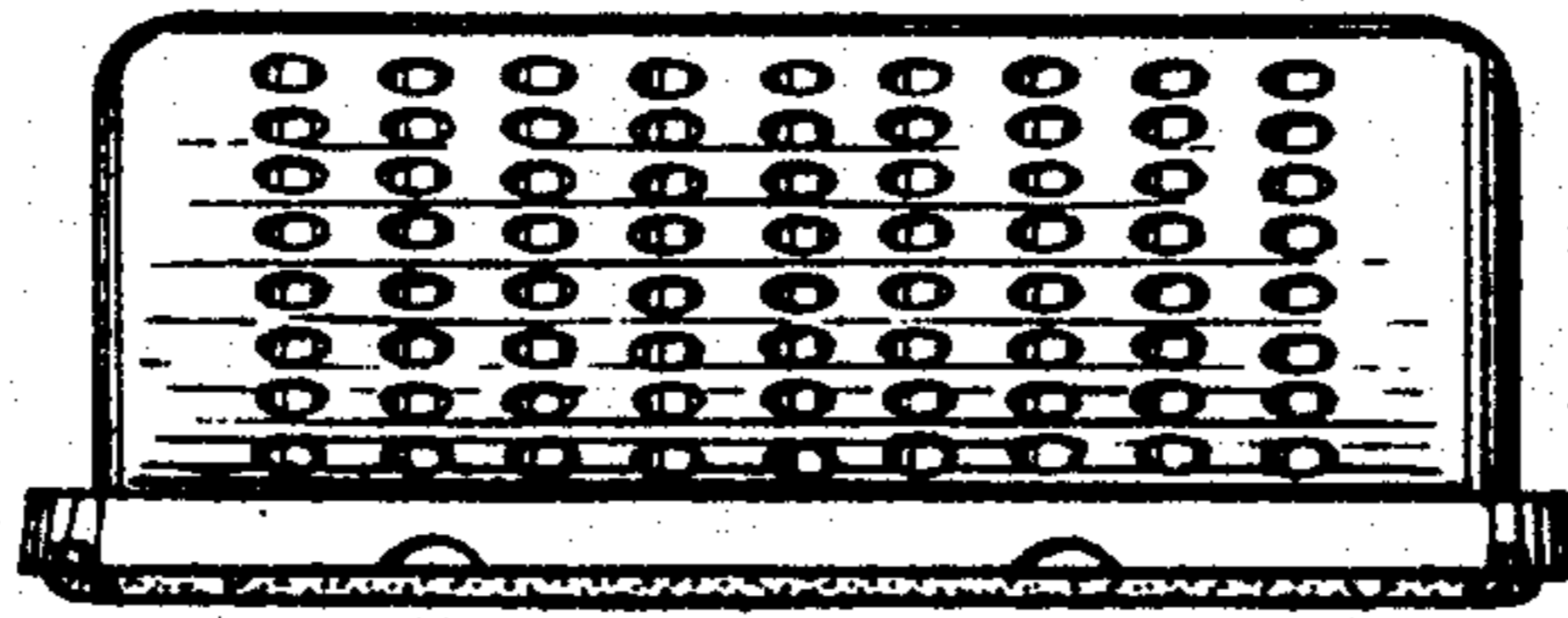

FIG. 4

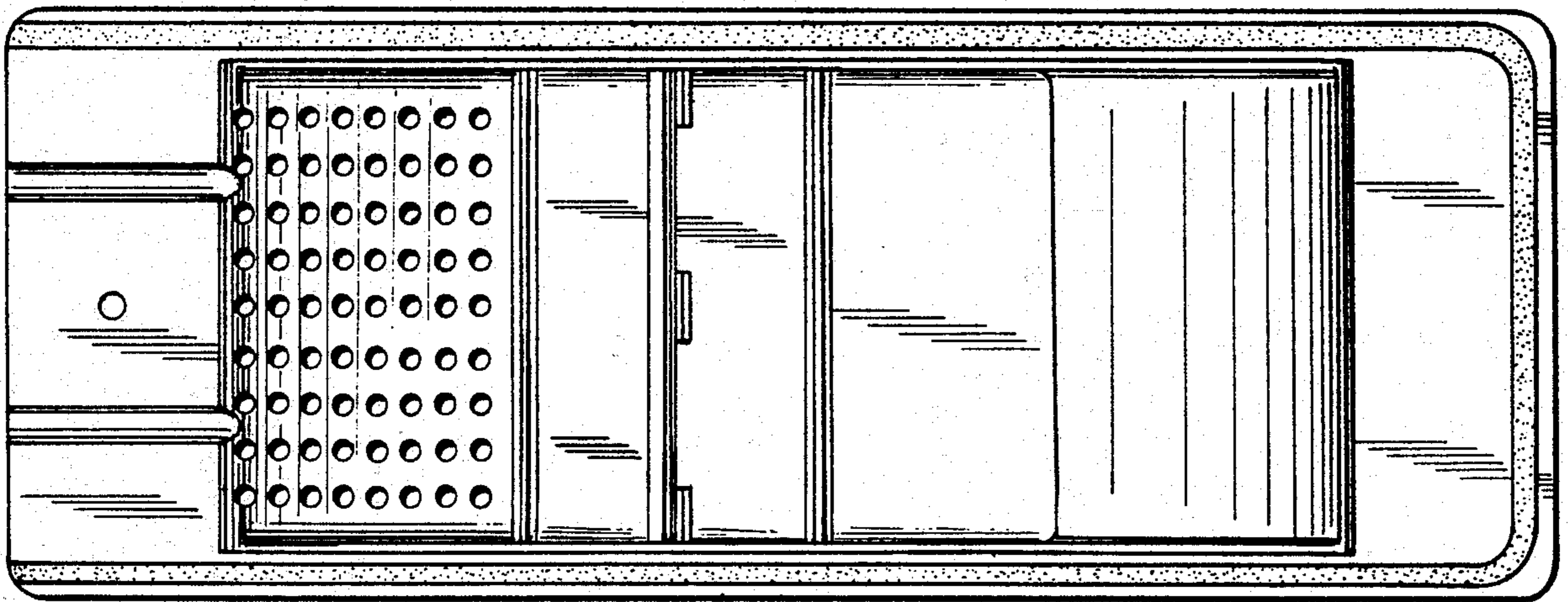

FIG. 5

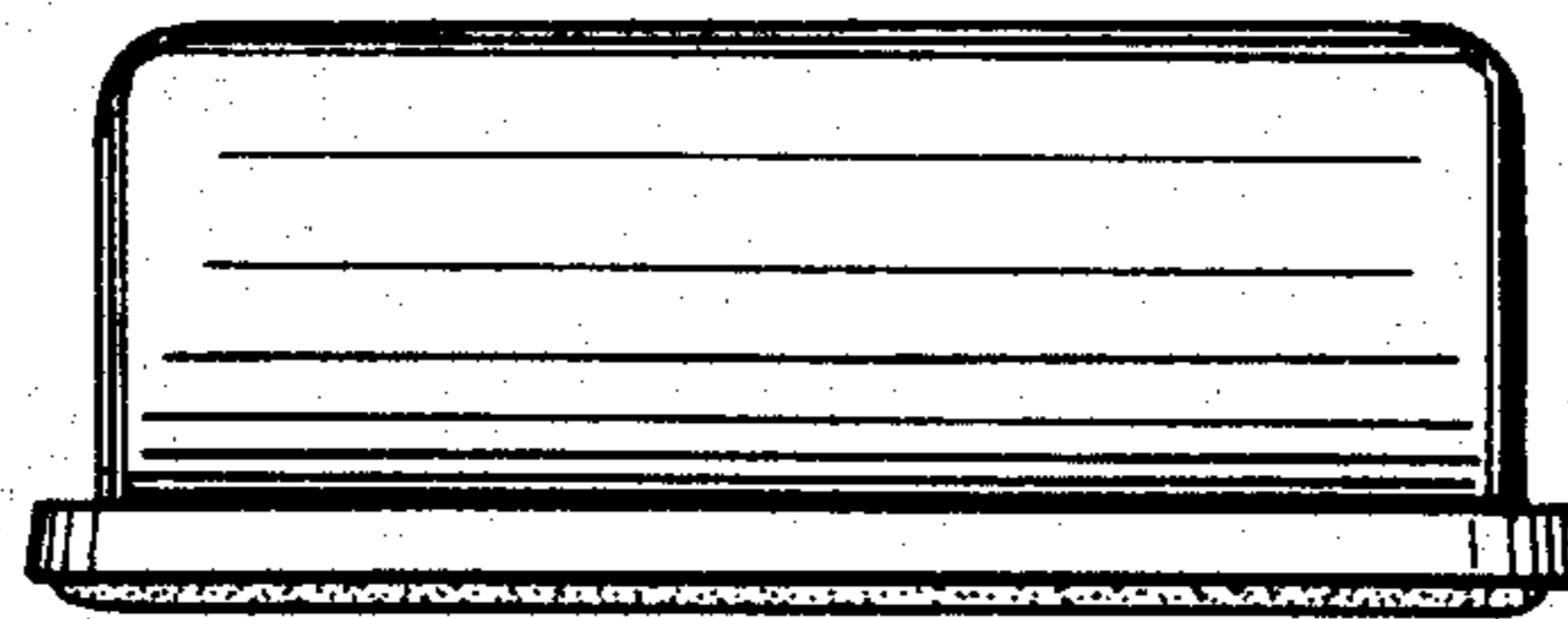

FIG. 6