

[54] CAROUSEL JEWELRY BOX

[76] Inventor: Judith A. Richwine, 4041 Gill Ave., Hampstead, Md. 21074

[**] Term: 14 Years

[21] Appl. No.: 543,164

[22] Filed: Oct. 18, 1983

[52] U.S. Cl. D3/30.1

[58] Field of Search D3/30.1, 74, 75; D6/432, 445, 448, 559, 561; D9/341; D8/372, 370, 310, 300; 206/278, 292, 372; 211/113, 115; 248/339; 312/324, 245

[56] References Cited

U.S. PATENT DOCUMENTS

D. 5,277	9/1871	Lis	D9/341
D. 6,956	10/1873	Hollis	D8/310
D. 266,115	9/1982	Glenn, Sr. et al.	D3/75
D. 280,156	8/1985	Allen et al.	D6/432
2,253,286	8/1941	Cronan	211/115
2,644,421	7/1953	Arceo	312/324
2,835,359	5/1958	Boldt et al.	312/324
2,966,385	12/1960	Murphy et al.	312/245 X

4,058,356 11/1977 Michal 312/324 X
4,270,821 6/1981 Verdesca 312/245

Primary Examiner—Bernard Ansher
Assistant Examiner—Linda Titolo
Attorney, Agent, or Firm—John F. McClellan, Sr.

[57] CLAIM

The ornamental design for a carousel jewelry box, substantially as shown and described.

DESCRIPTION

FIG. 1 is a front bottom perspective view of a carousel jewelry box, showing my new design, with the doors in an open position;
FIG. 2 is a top right side perspective view thereof;
FIG. 3 is a top front right side perspective view thereof with the doors in a closed position;
FIG. 4 is a bottom rear left side perspective view thereof;
FIG. 5 is a right side elevational view thereof;
FIG. 6 is a top front perspective view thereof; and
FIG. 7 is an enlarged front bottom perspective view of a carousel member with hook elements, shown separately for clarity of illustration.

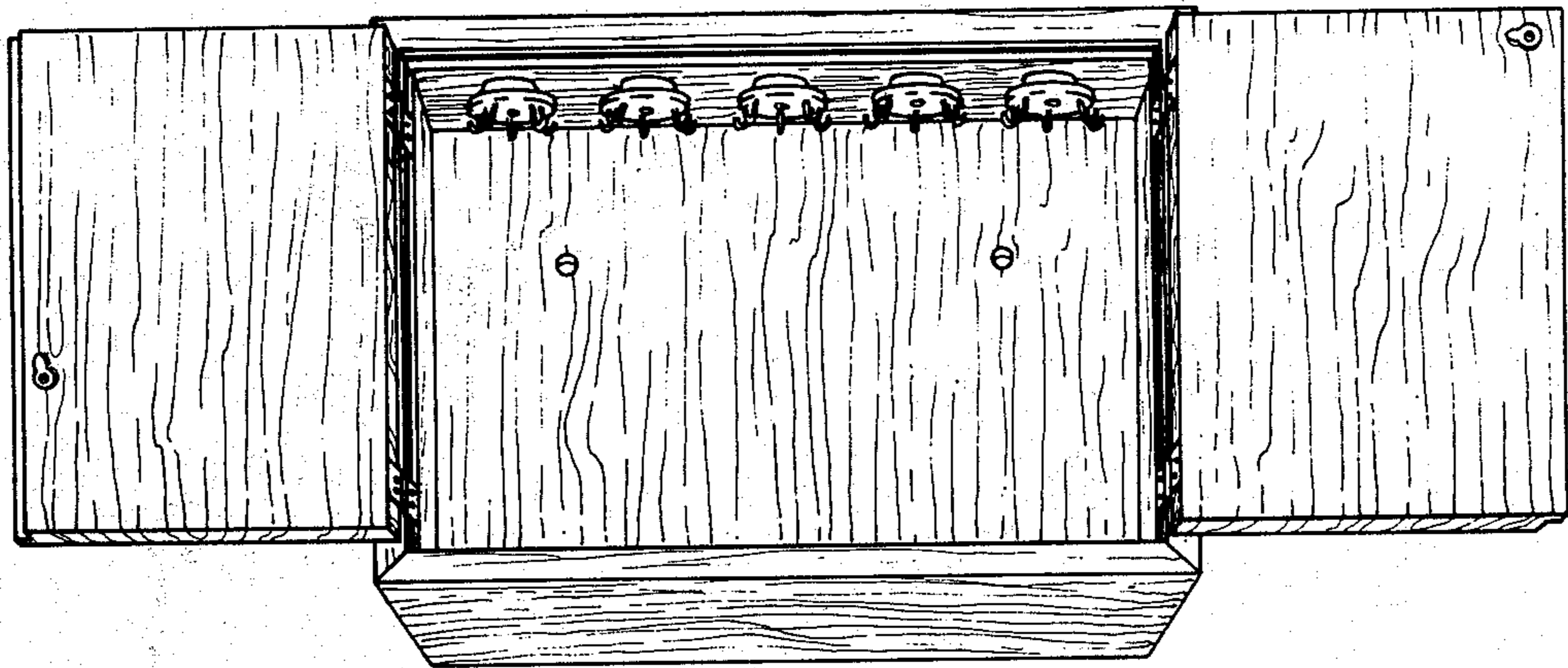

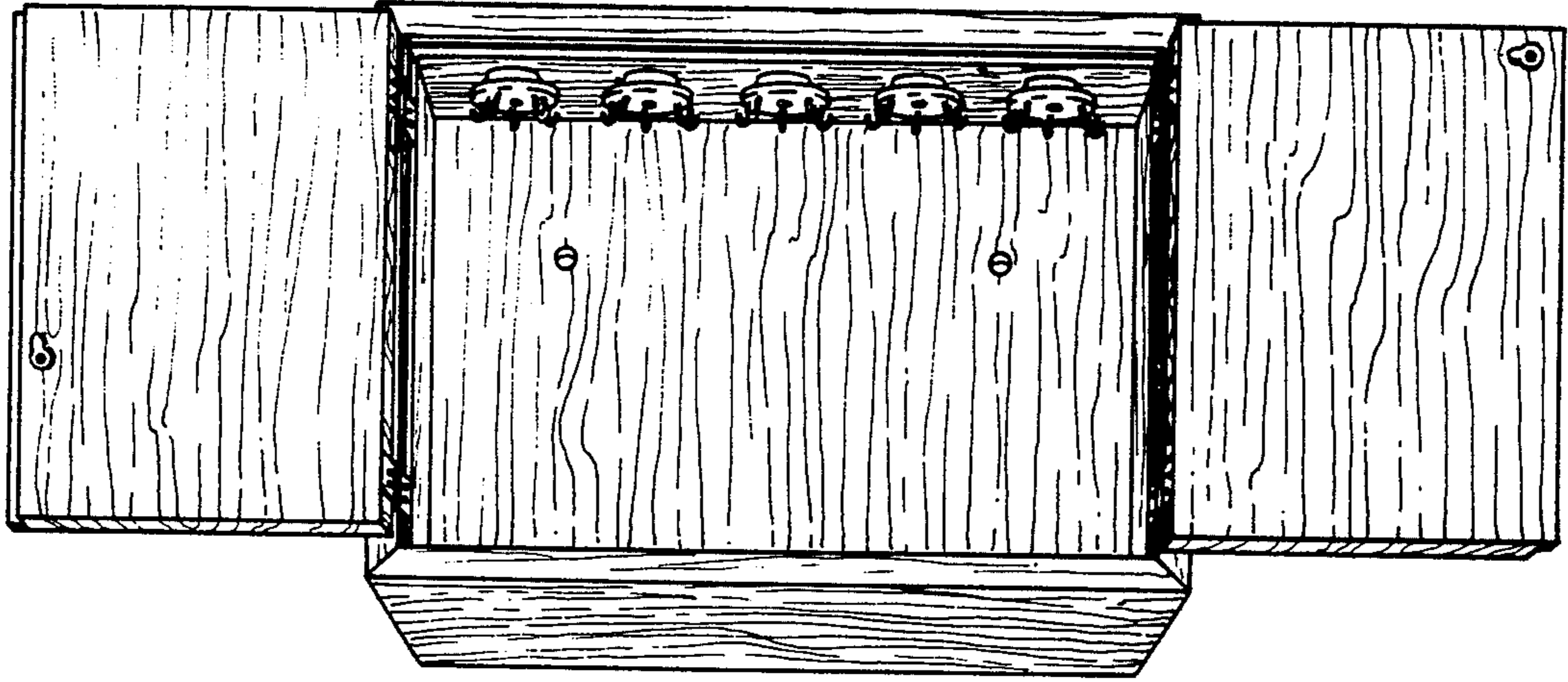

FIG. 1

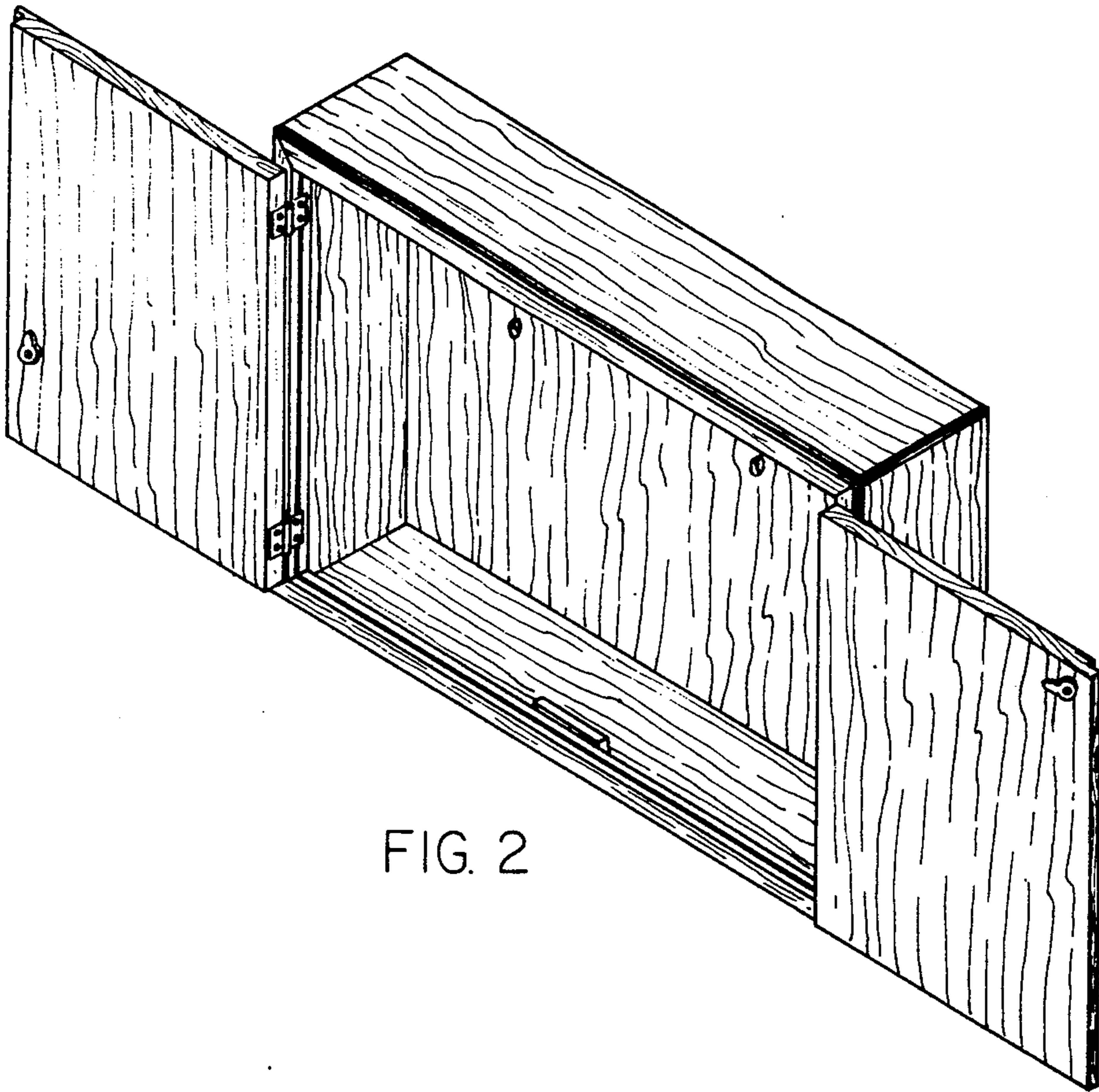

FIG. 2

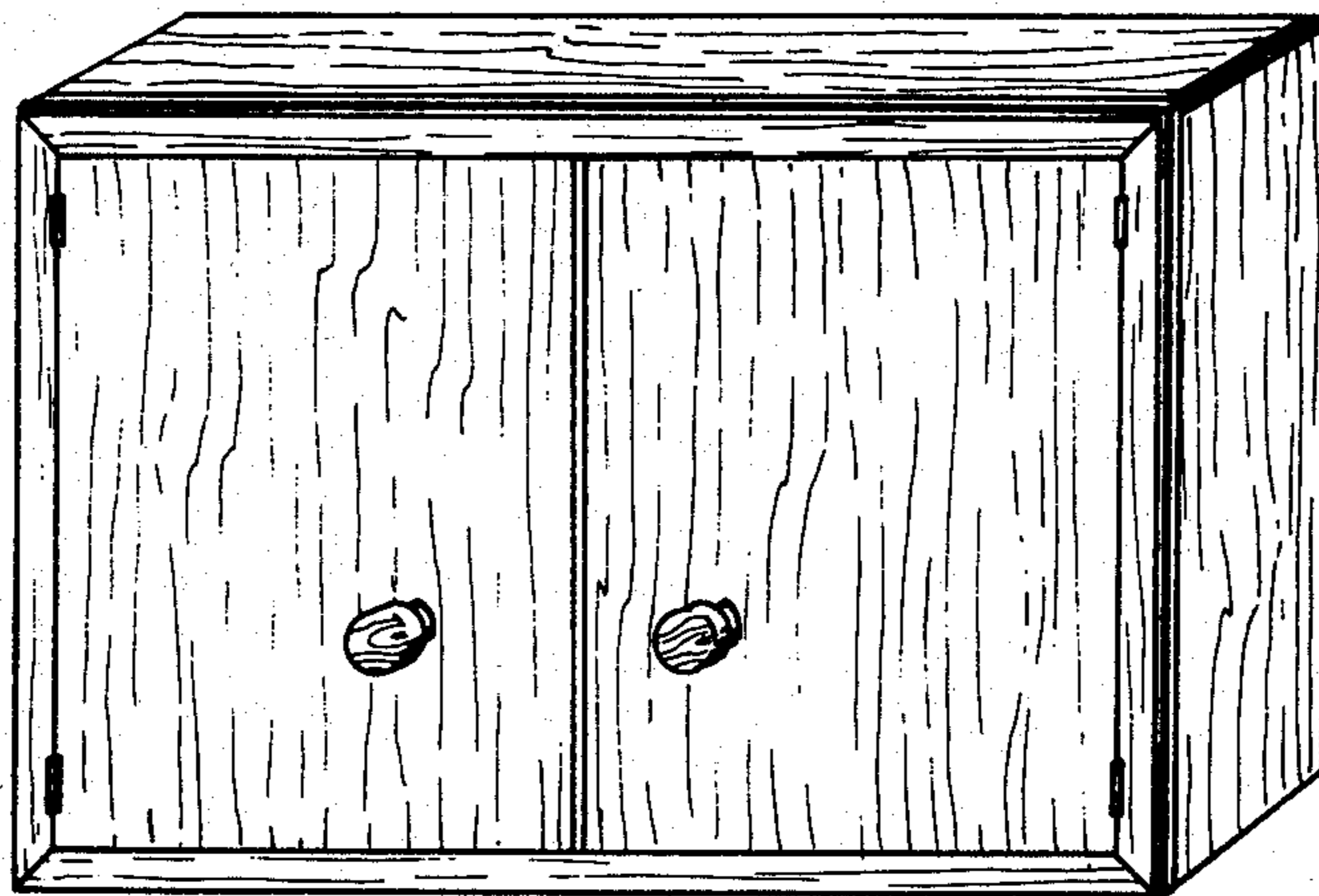

FIG. 3

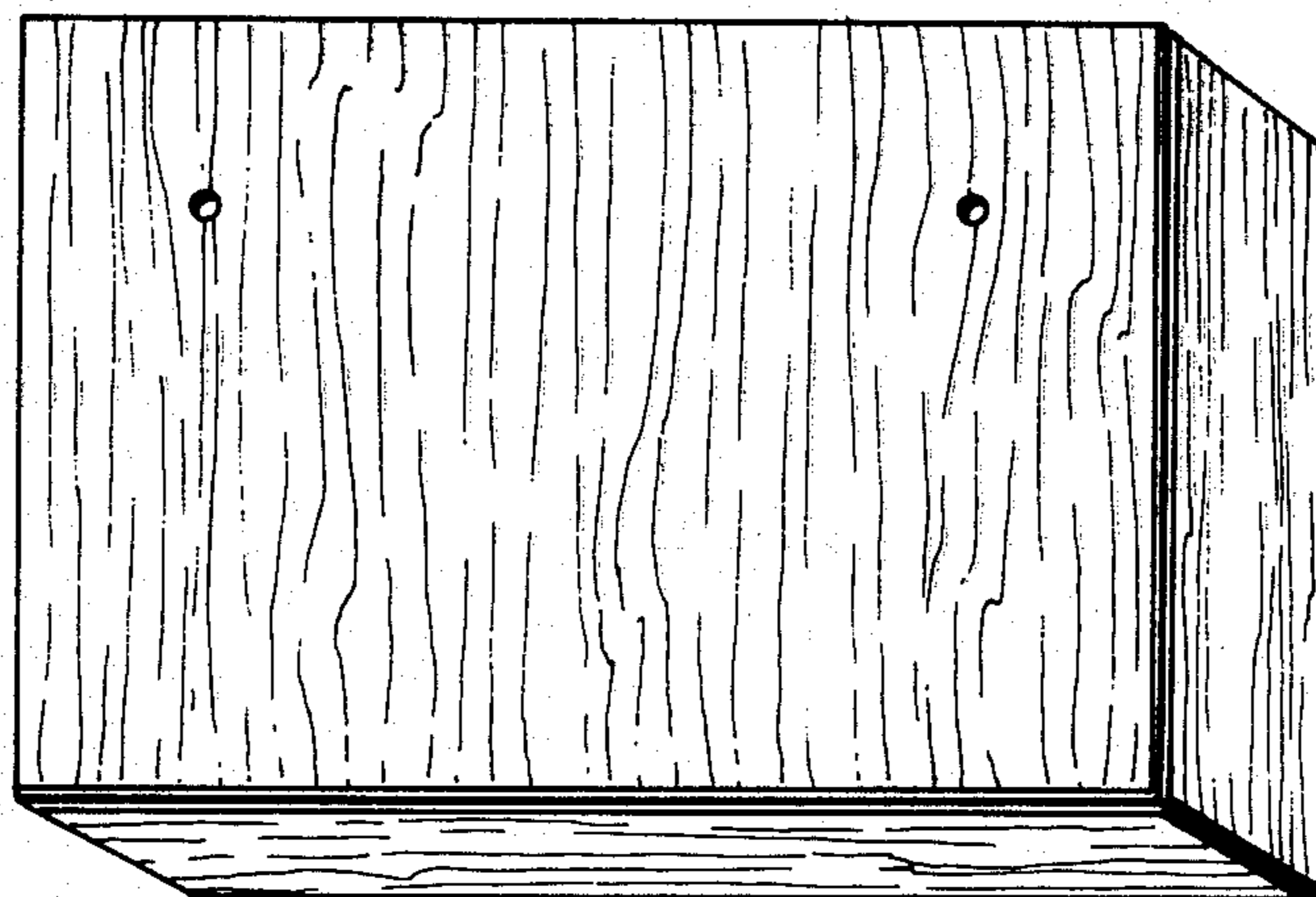

FIG. 4

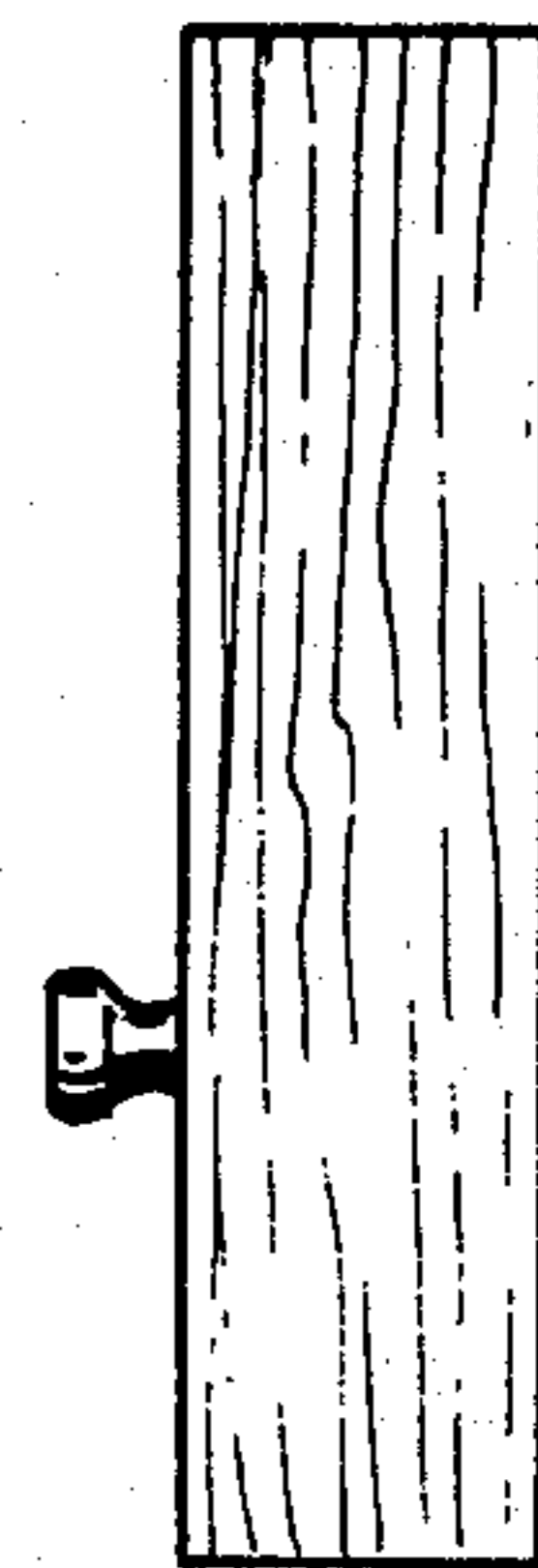

FIG. 5

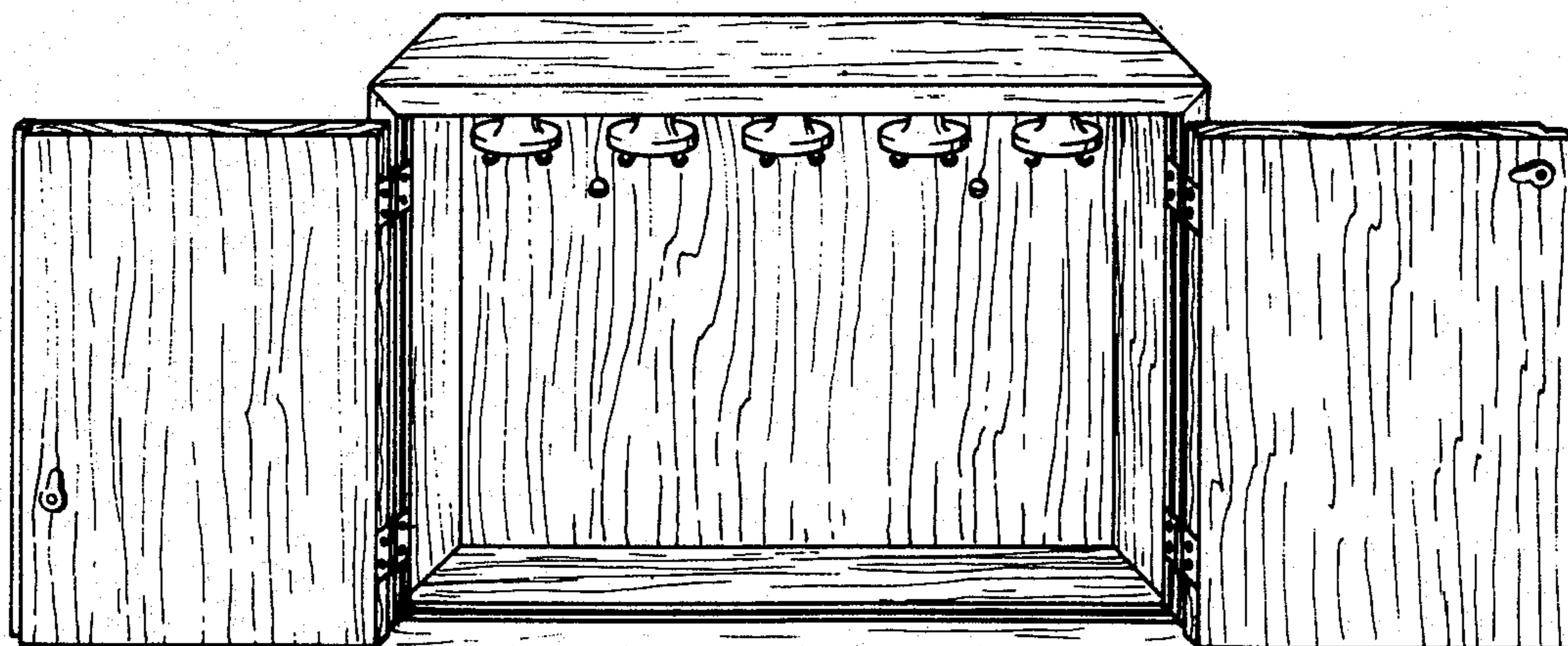

FIG. 6

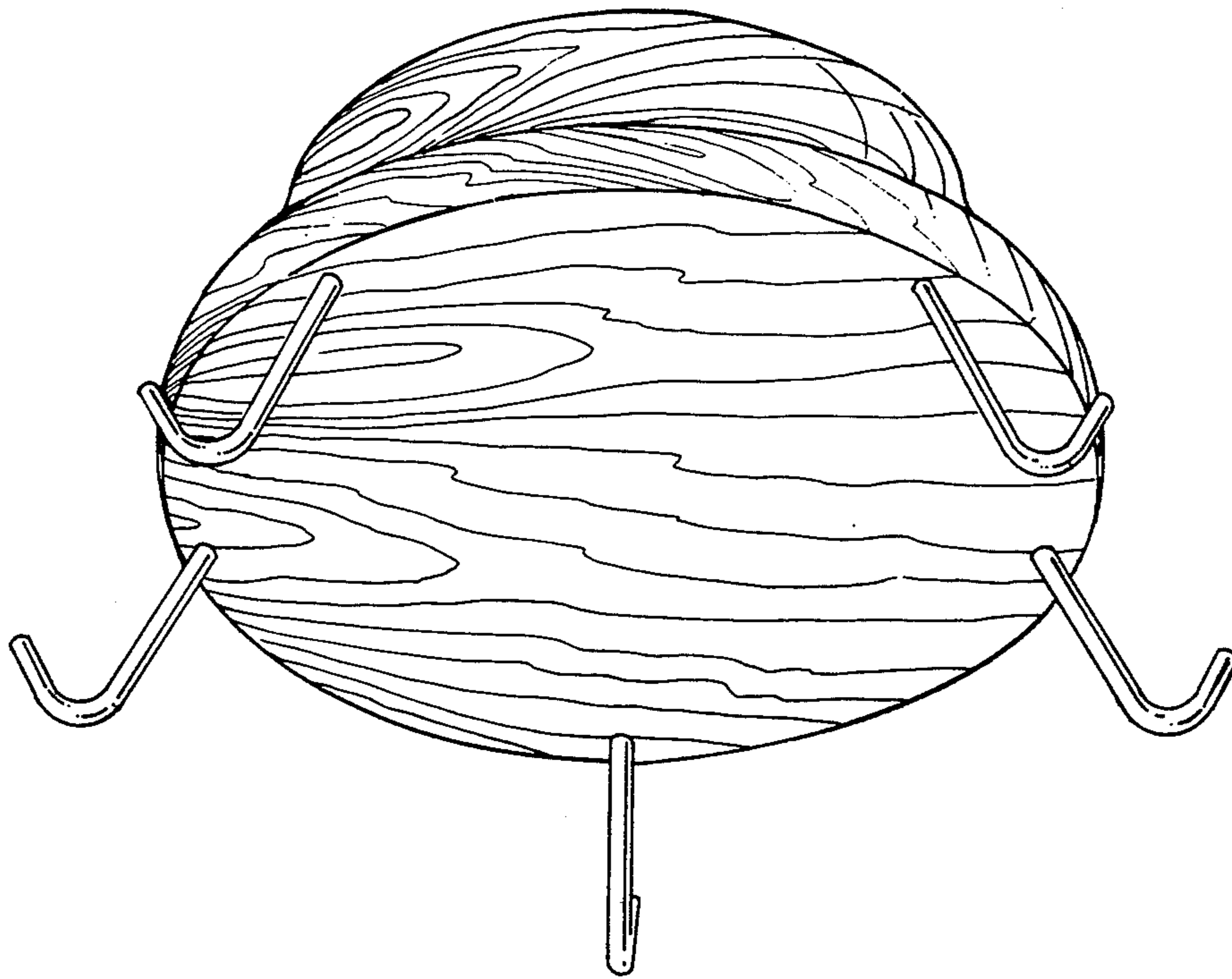

FIG. 7