

[54] SATELLITE DISH ANTENNA SUPPORT SPLIT RIB

[75] Inventors: John R. Winegard, Evergreen; Keith B. Cowan, Arvada, both of Colo.

[73] Assignee: Winegard Company, Burlington, Iowa

[**] Term: 14 Years

[21] Appl. No.: 569,836

[22] Filed: Jan. 11, 1984

[52] U.S. Cl. D14/90; D25/74

[58] Field of Search D14/86, 90, 91; 343/840, 912, 880, 881, 882; D25/74

[56] References Cited

U.S. PATENT DOCUMENTS

- D. 221,529 8/1971 Kimmel D25/74
- D. 266,953 11/1982 Goldhaber D25/74
- D. 271,423 11/1983 Sundeby et al. D25/74 X

Primary Examiner—Nelson C. Holtje
Assistant Examiner—Theodore M. Shooman

Attorney, Agent, or Firm—Robert C. Dorr

[57] CLAIM

The ornamental design for a satellite dish antenna support split rib, as shown and described.

DESCRIPTION

FIG. 1 is a top and front perspective view of a satellite dish antenna support split rib showing our new design; FIG. 2 is an enlarged top and front perspective view thereof;

FIG. 3 is an enlarged top plan view thereof;

FIG. 4 is an enlarged front elevational view thereof;

FIG. 5 is an enlarged right side elevational view thereof;

FIG. 6 is an enlarged bottom plan view thereof;

FIG. 7 is an enlarged left side elevational view thereof; and

FIG. 8 is an enlarged rear elevational view thereof.

The satellite dish antenna support split rib shown in FIGS. 2, 3, 4, 6 and 8 is broken away to indicate indeterminate length.

The broken line showing of the internal structure is for illustrative purposes only and forms no part of the claimed design.

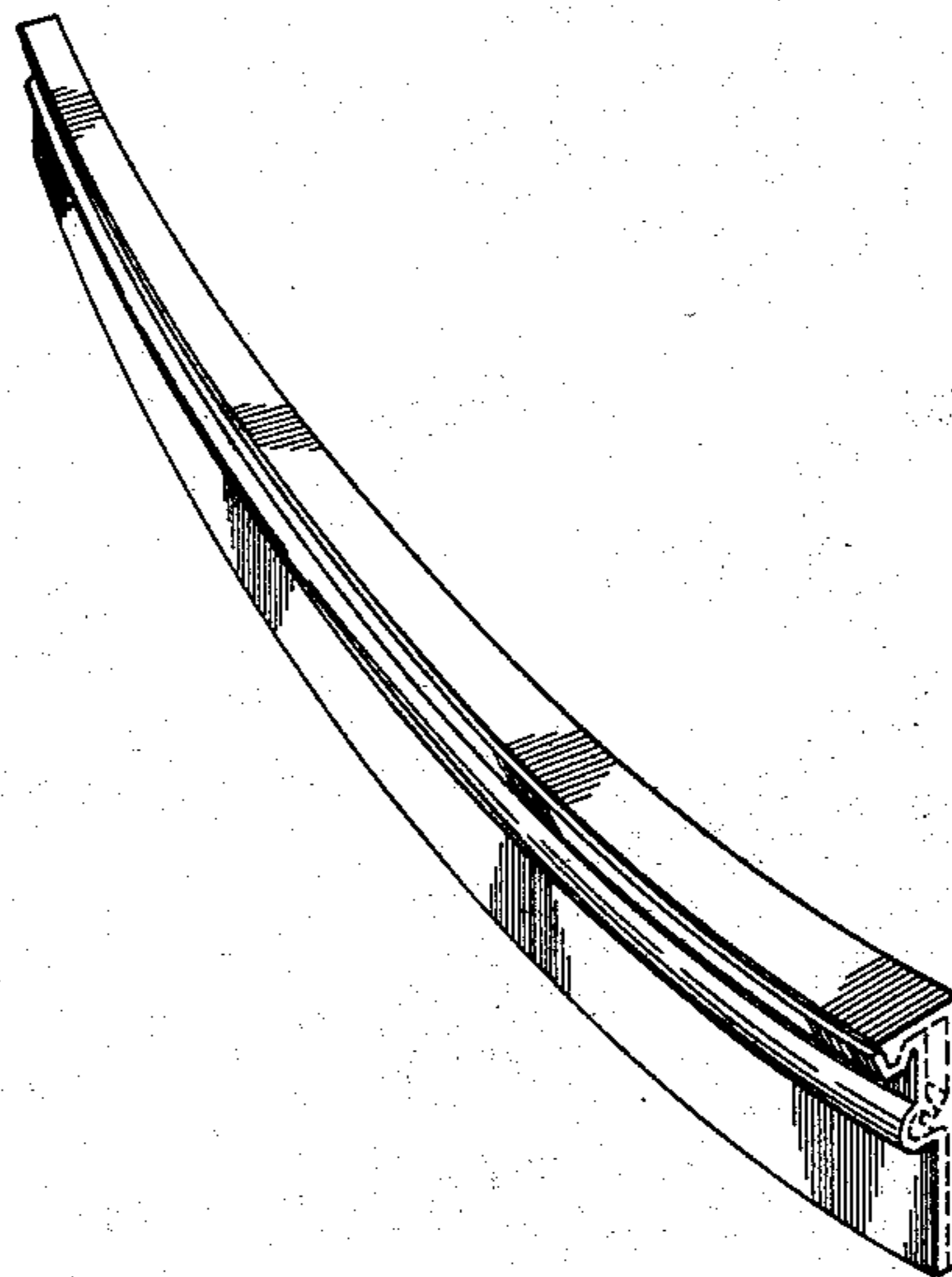

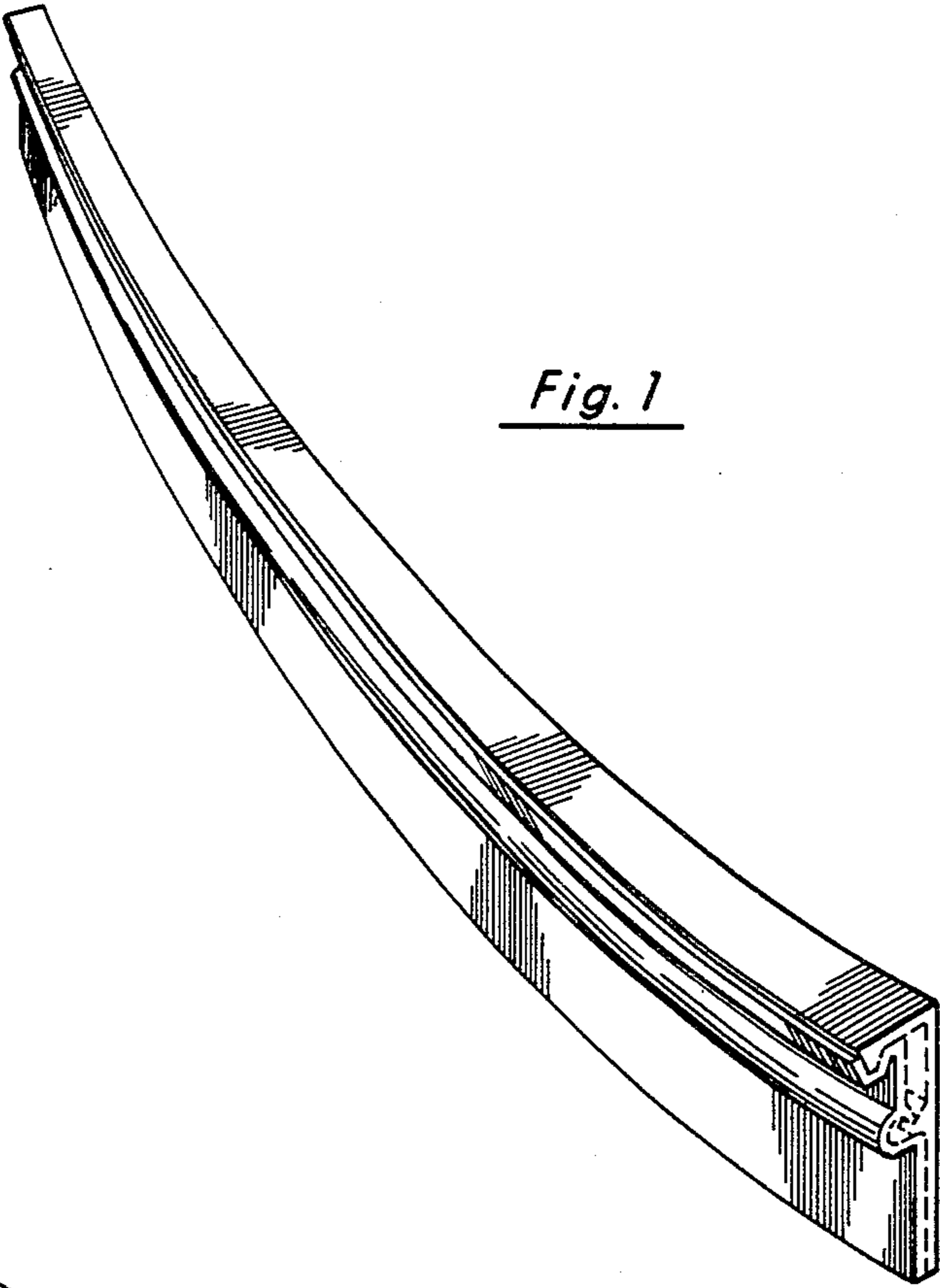

Fig. 1

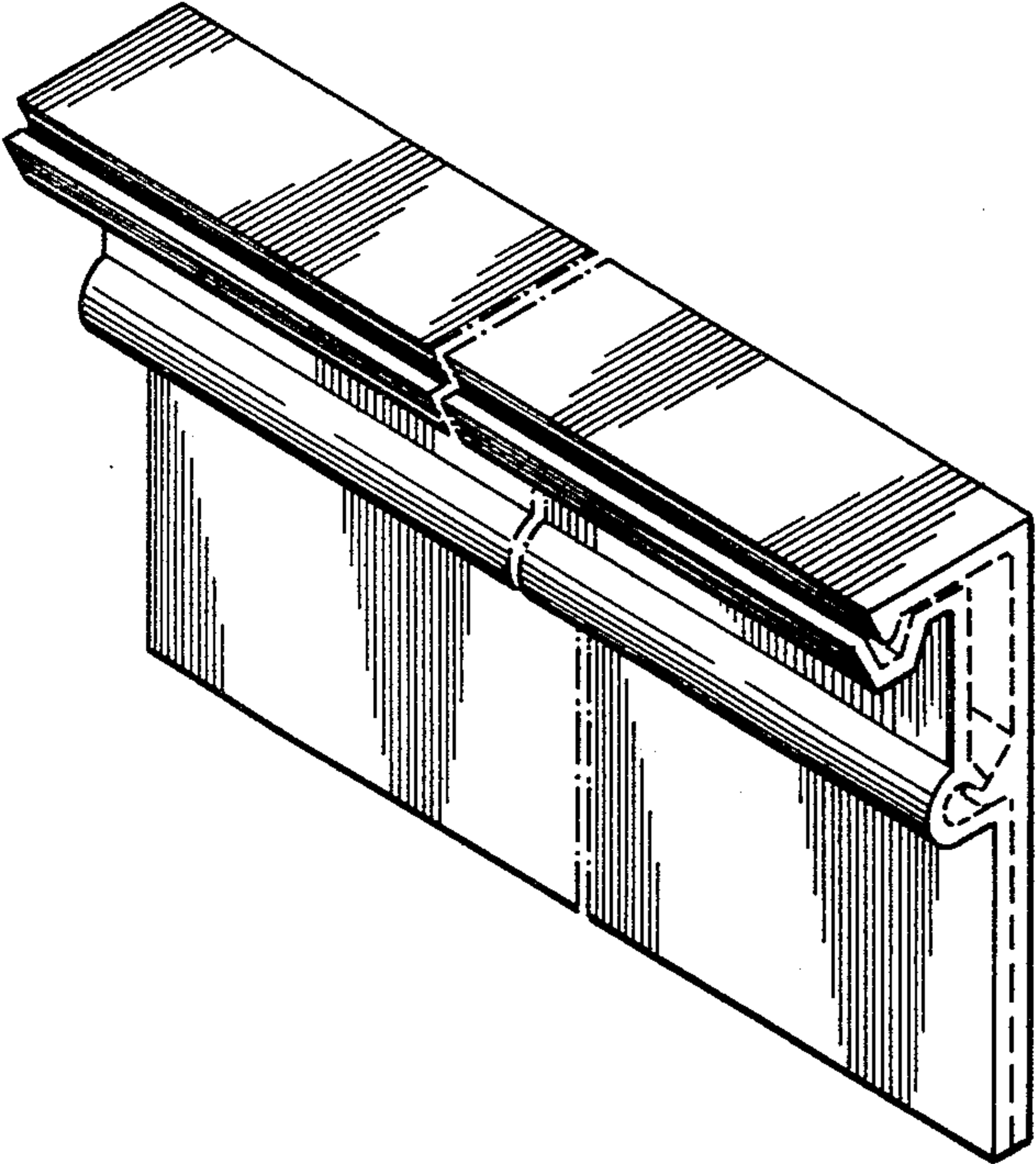

Fig. 2

Fig. 3

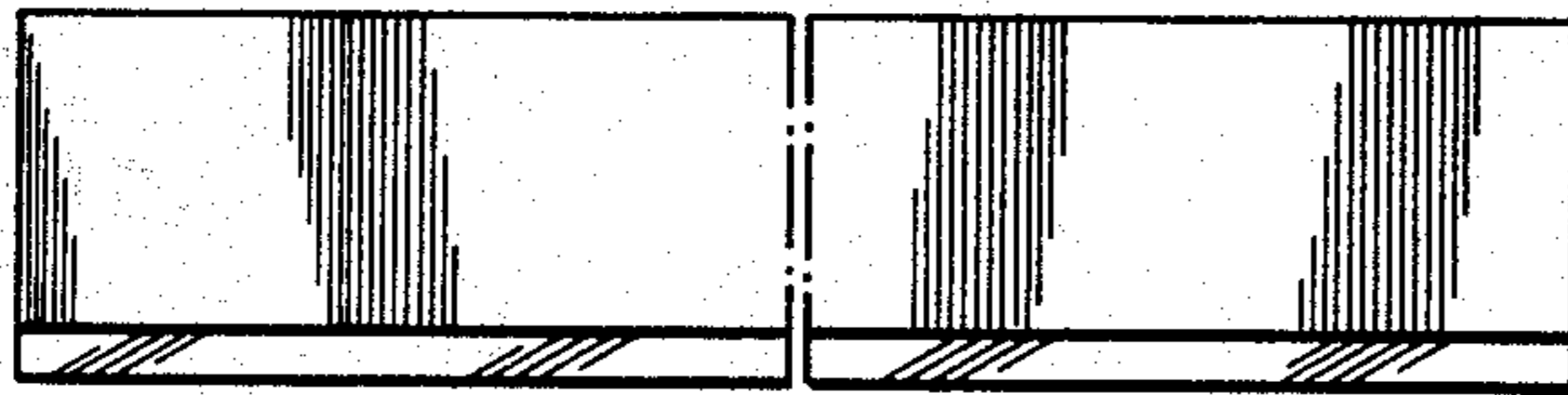

Fig. 4

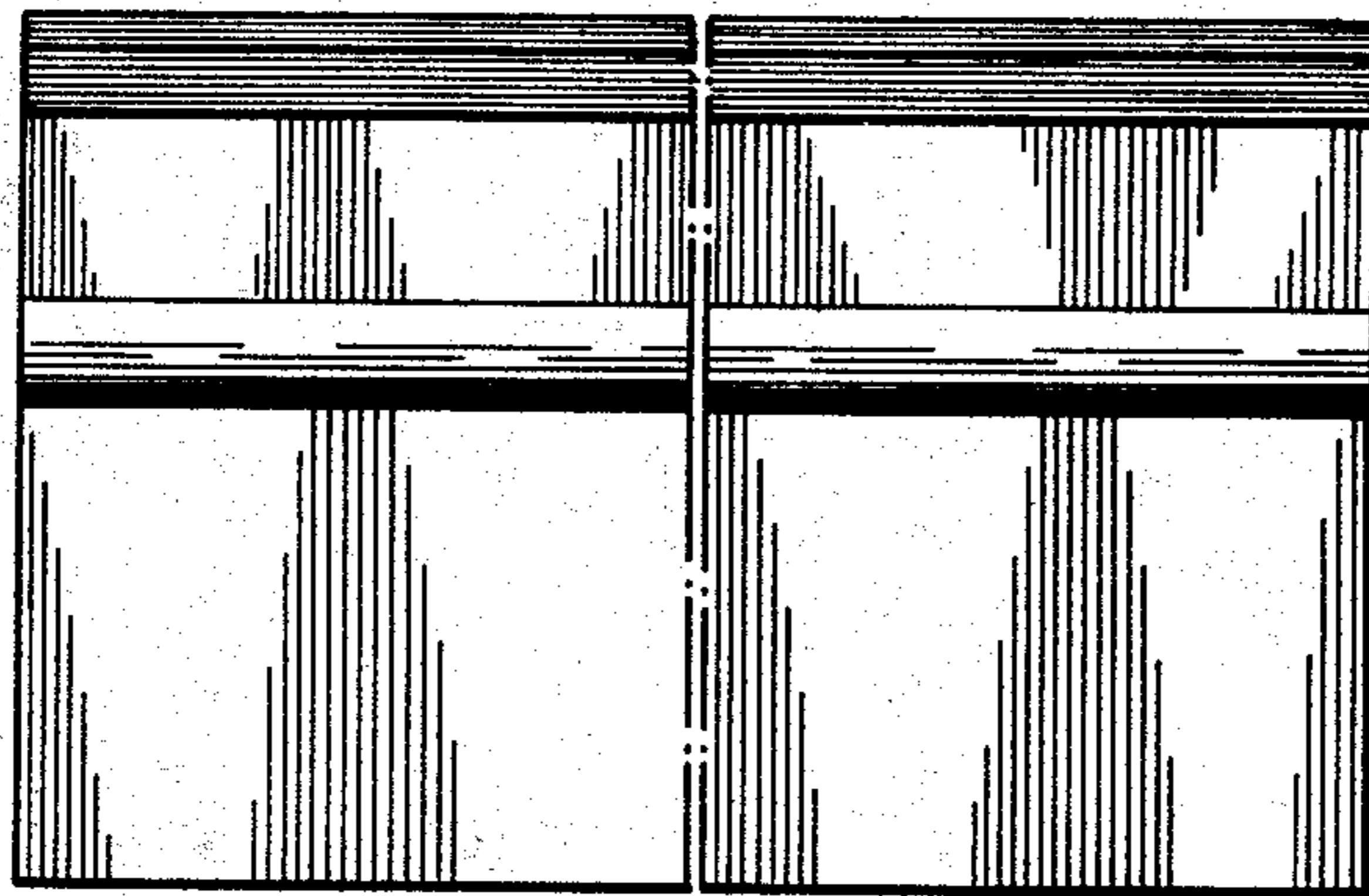

Fig. 5



Fig. 6

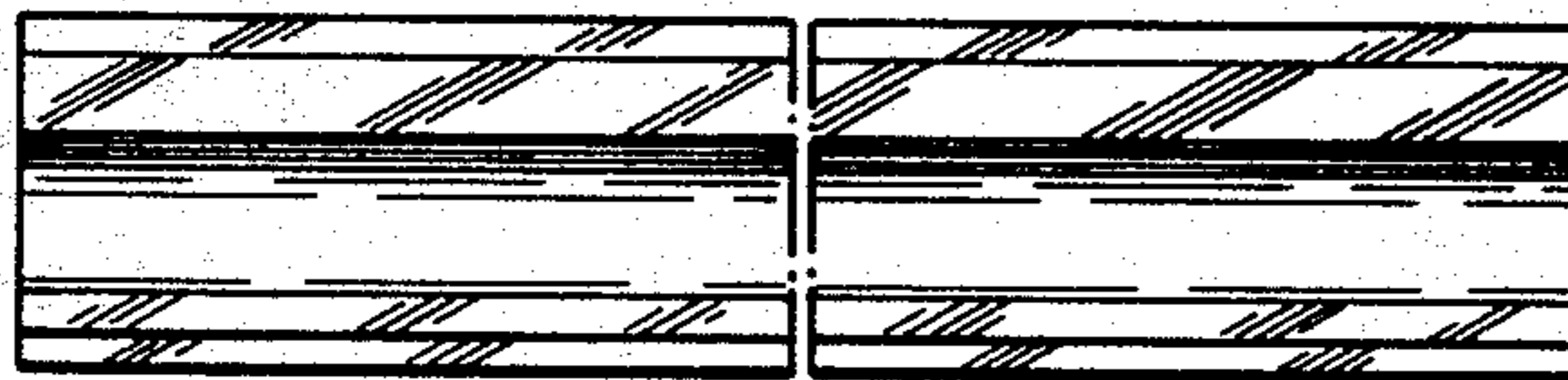

Fig. 8

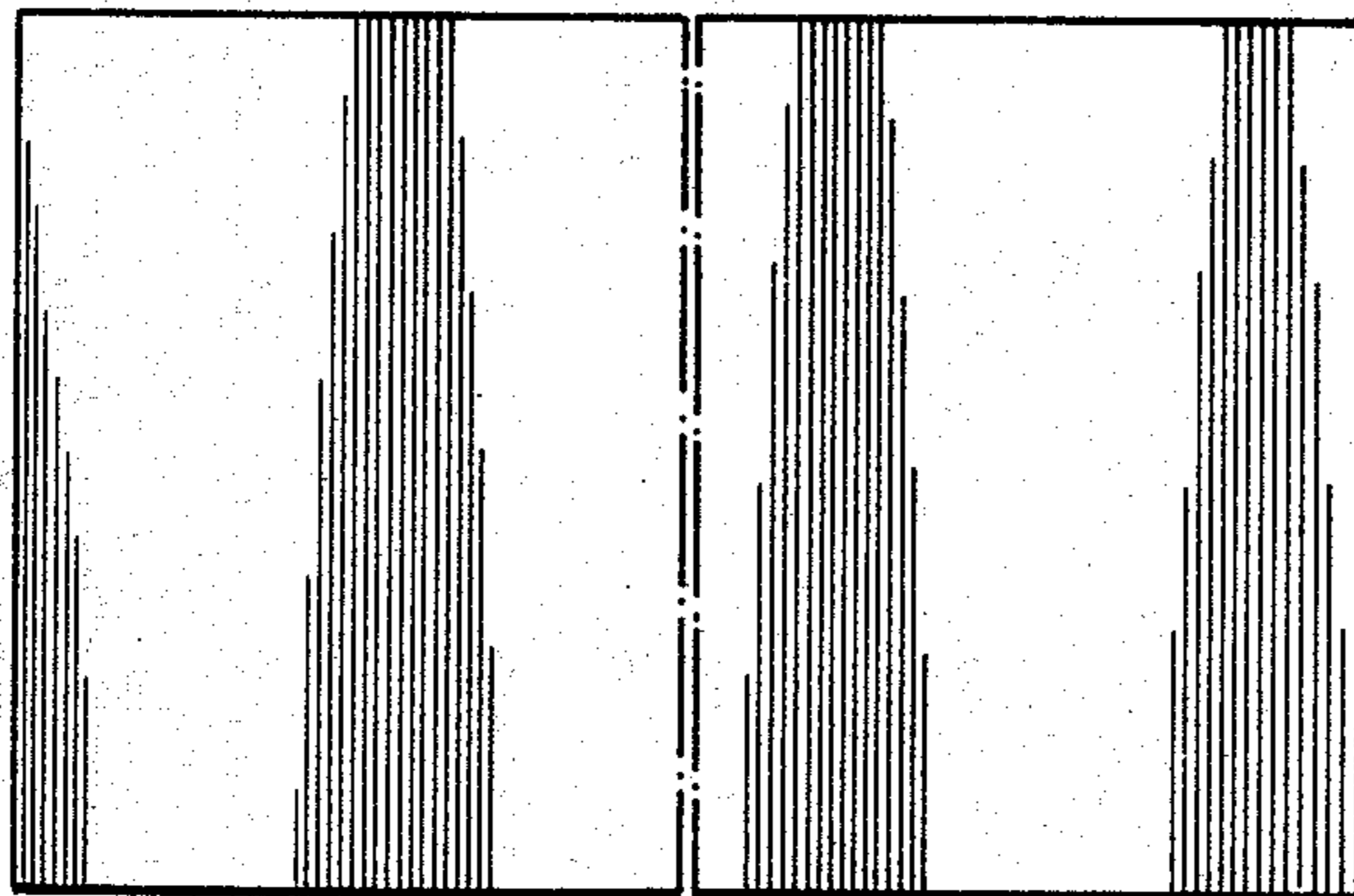

Fig. 7

