

[54] COMBINED GUTTER SUPPORT AND JOINTING BRACKET

[75] Inventors: Robert W. Parker, Bearsted; David E. Wells, Kent, both of England

[73] Assignee: Reed International PLC, London, England

[**] Term: 14 Years

[21] Appl. No.: 556,426

[22] Filed: Nov. 30, 1983

[30] Foreign Application Priority Data

Jun. 9, 1983 [GB] United Kingdom 1013478
[52] U.S. Cl. D8/380
[58] Field of Search D8/373, 380; D23/45; D25/75; 52/11; 405/118, 119, 121, 122; 248/48.2

[56] References Cited

U.S. PATENT DOCUMENTS

3,253,415 5/1966 Davidson 405/119
3,331,574 7/1967 Davidson 248/48.2
3,357,143 12/1967 Bayes et al. 52/11
3,841,101 10/1974 Henfrey 405/122
4,257,716 3/1981 Woodrow 405/118
4,305,236 12/1981 Williams 52/11

FOREIGN PATENT DOCUMENTS

2066872 7/1981 United Kingdom 52/11

Primary Examiner—B. J. Bullock
Attorney, Agent, or Firm—Hayes, Davis & Soloway

[57] CLAIM

The ornamental design for a combined gutter support and jointing bracket, as shown and described.

DESCRIPTION

FIG. 1 is a front view of a combined gutter support and jointing bracket showing our new design;
FIG. 2 is a top view thereof;
FIG. 3 is a rear view thereof;
FIG. 4 is a bottom view thereof;
FIG. 5 is a right end view thereof, the left end being a mirror image;
FIG. 6 is an enlarged fragmentary sectional view taken in the direction of the arrows on line VI—VI of FIG. 2;
FIG. 7 is a front view of a second embodiment of the design of FIG. 1;
FIG. 8 is a top view of FIG. 7;
FIG. 9 is a rear view of FIG. 7;
FIG. 10 is a bottom view of FIG. 7;
FIG. 11 is a right end view of FIG. 7, the left end being a mirror image;
FIG. 12 is an enlarged fragmentary sectional view taken in the direction of the arrows on line XII—XII of FIG. 8.

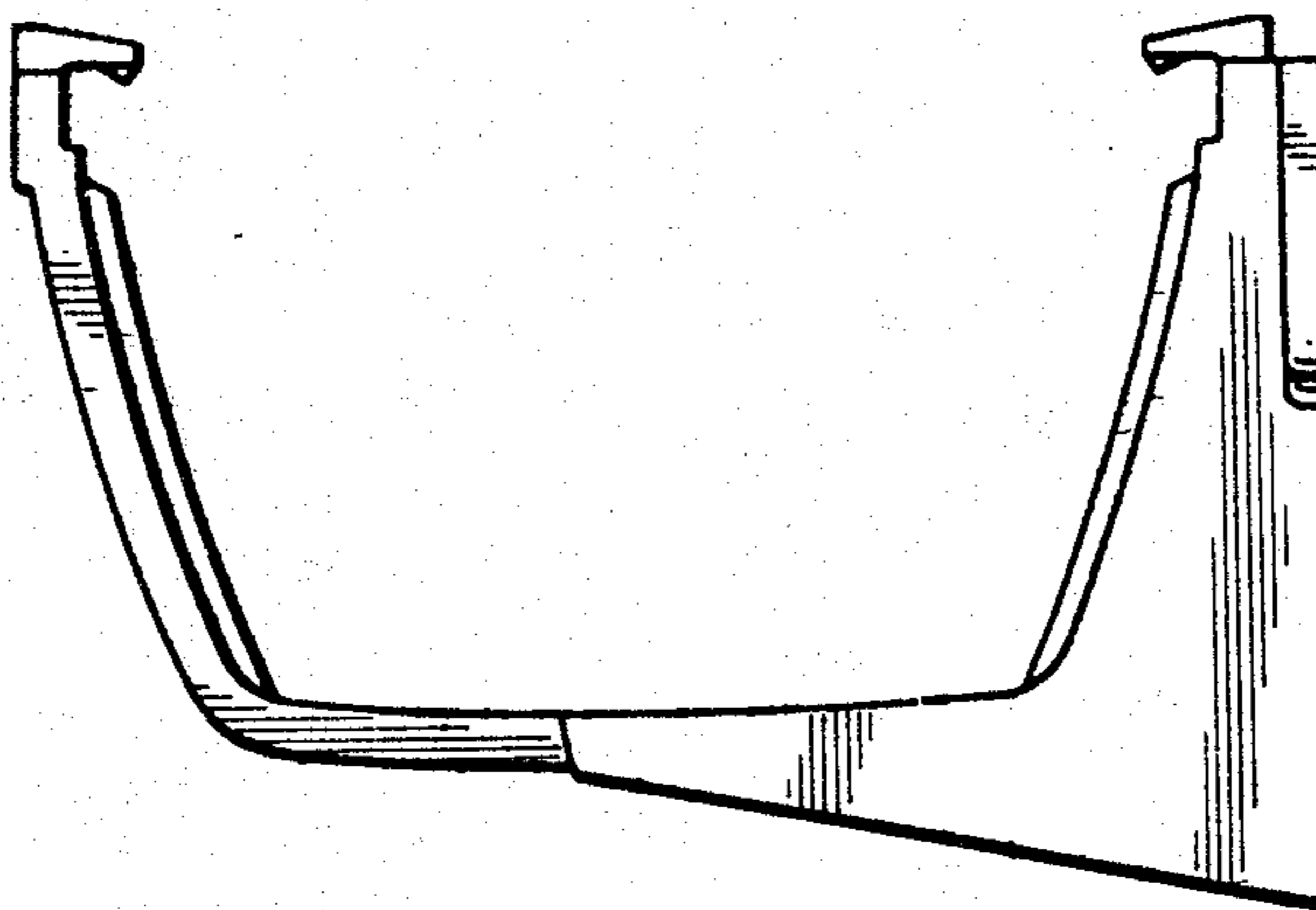
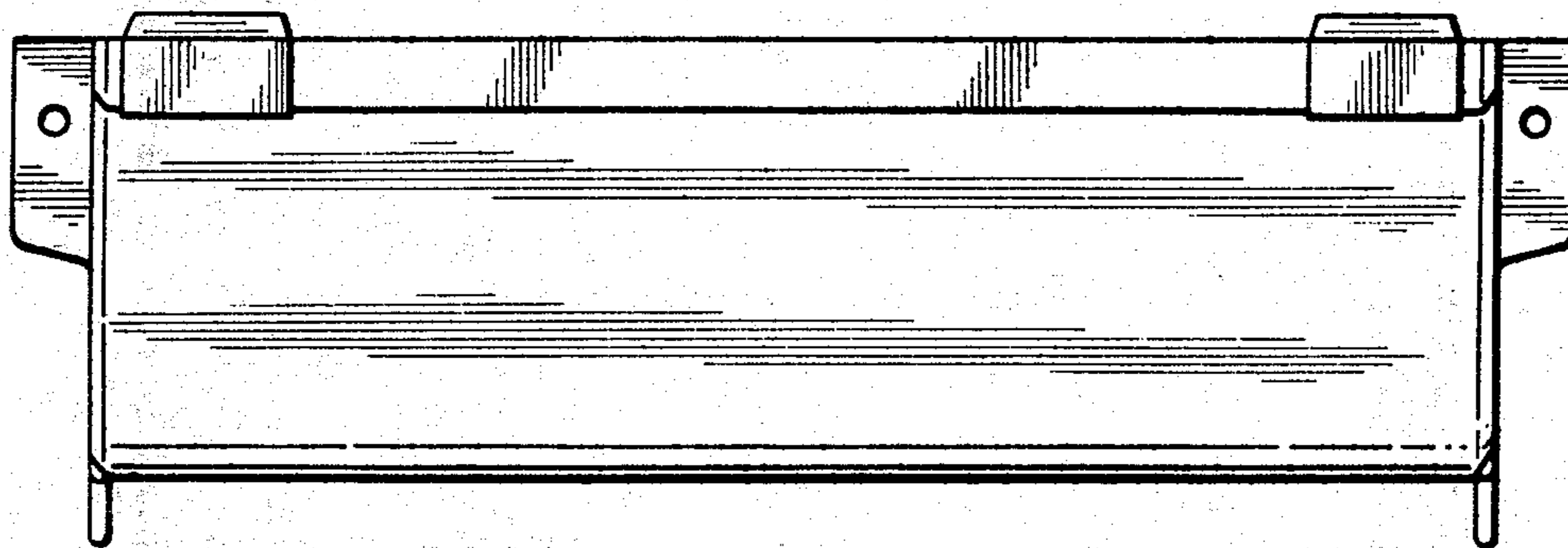

FIG. 1

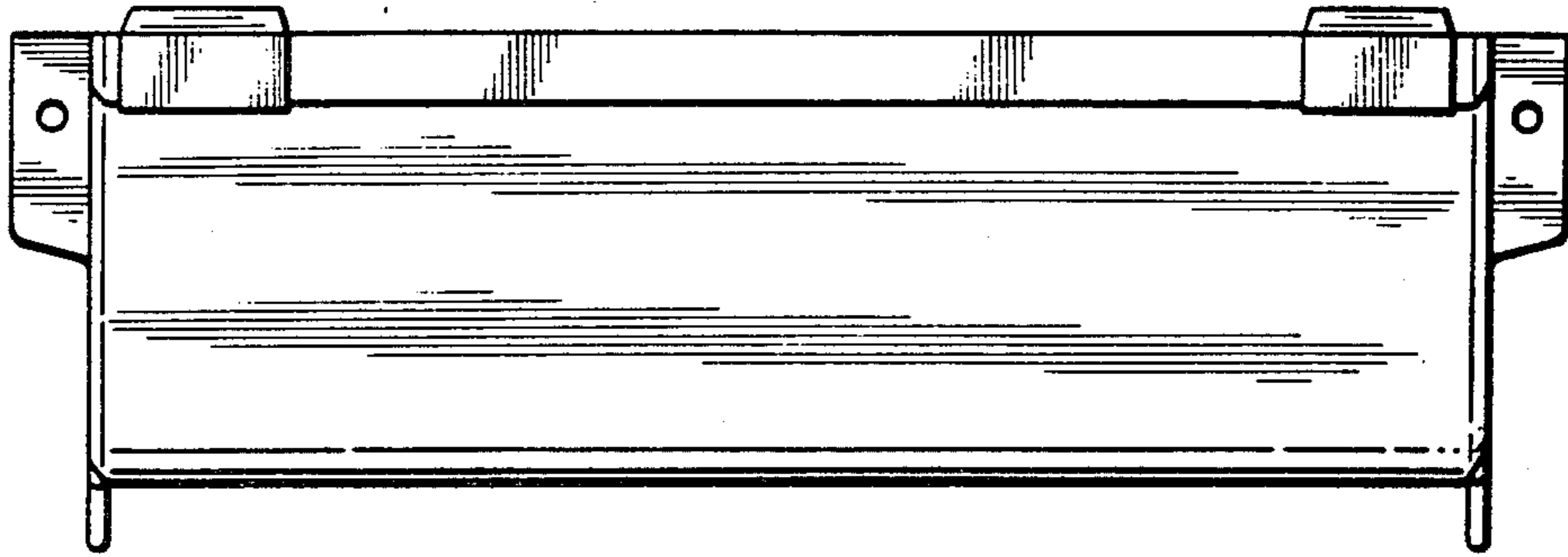

FIG. 2

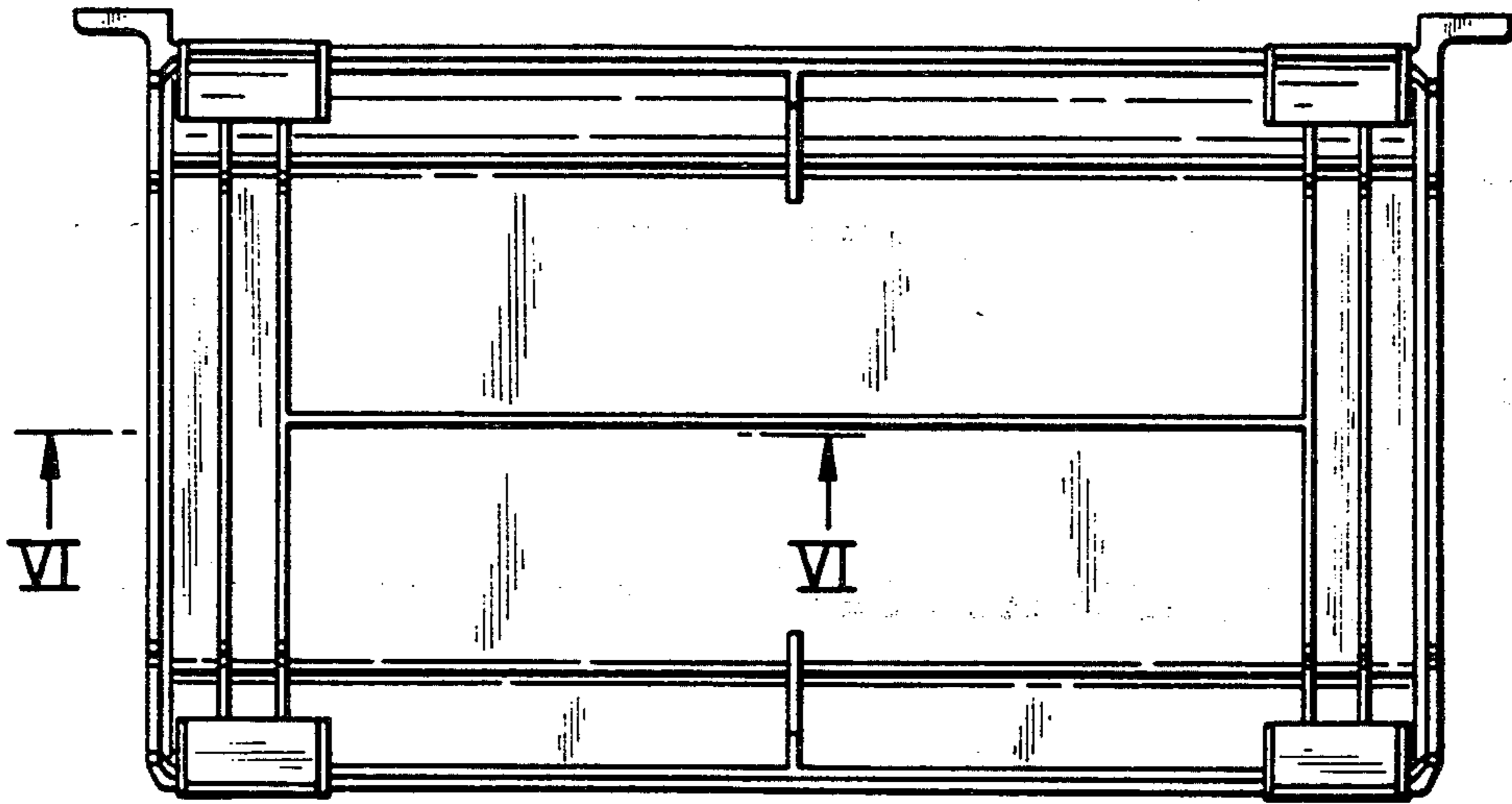

FIG. 3

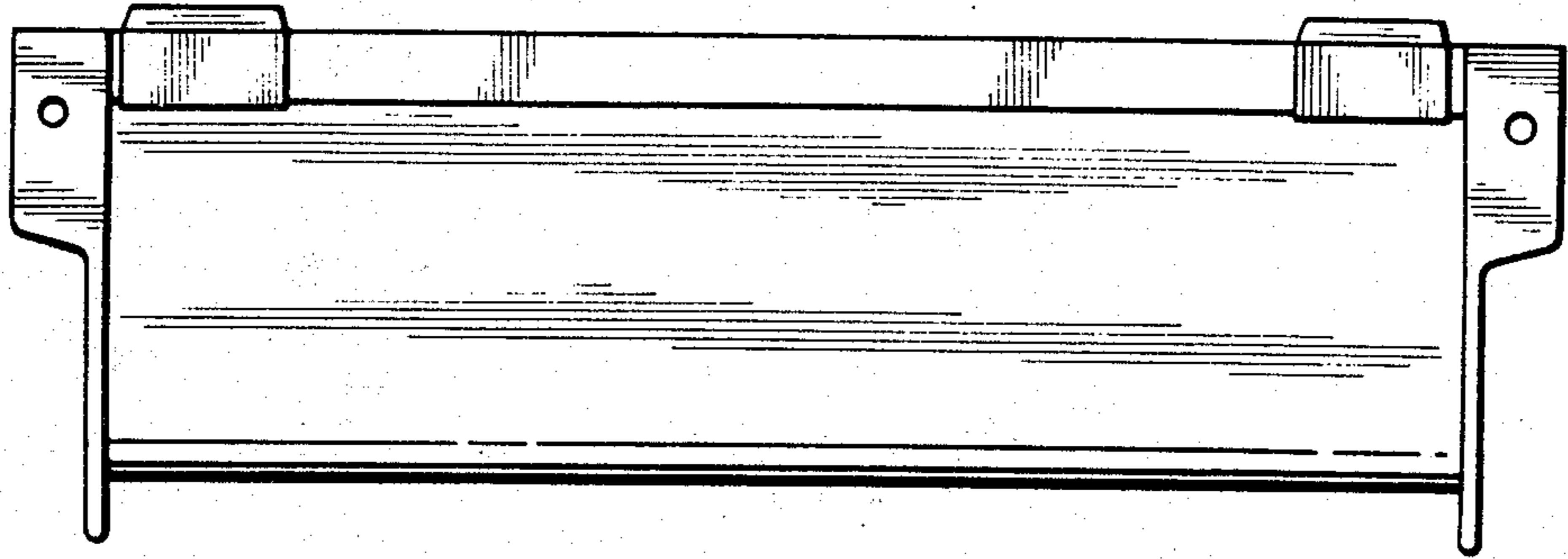

FIG. 4

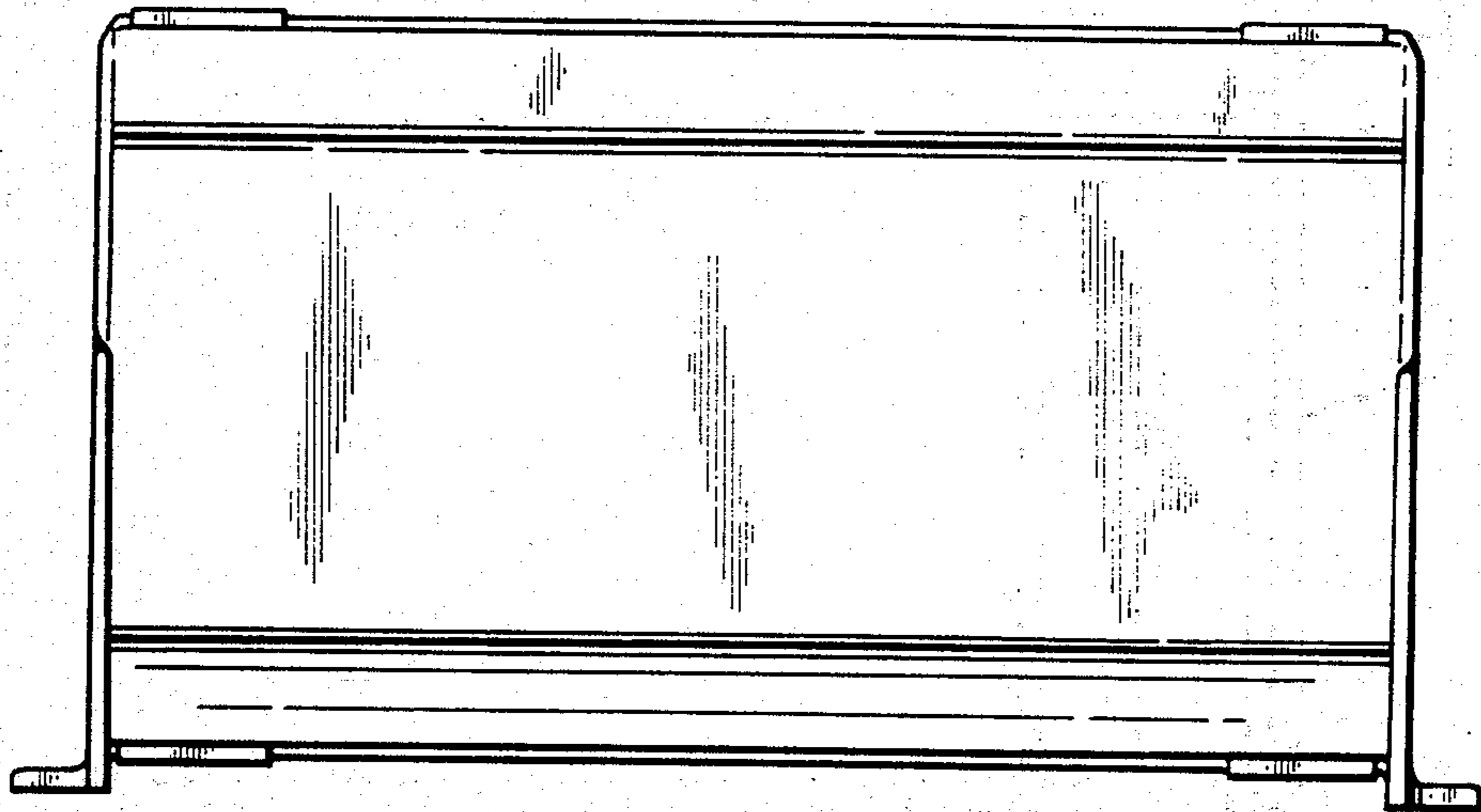

FIG. 5

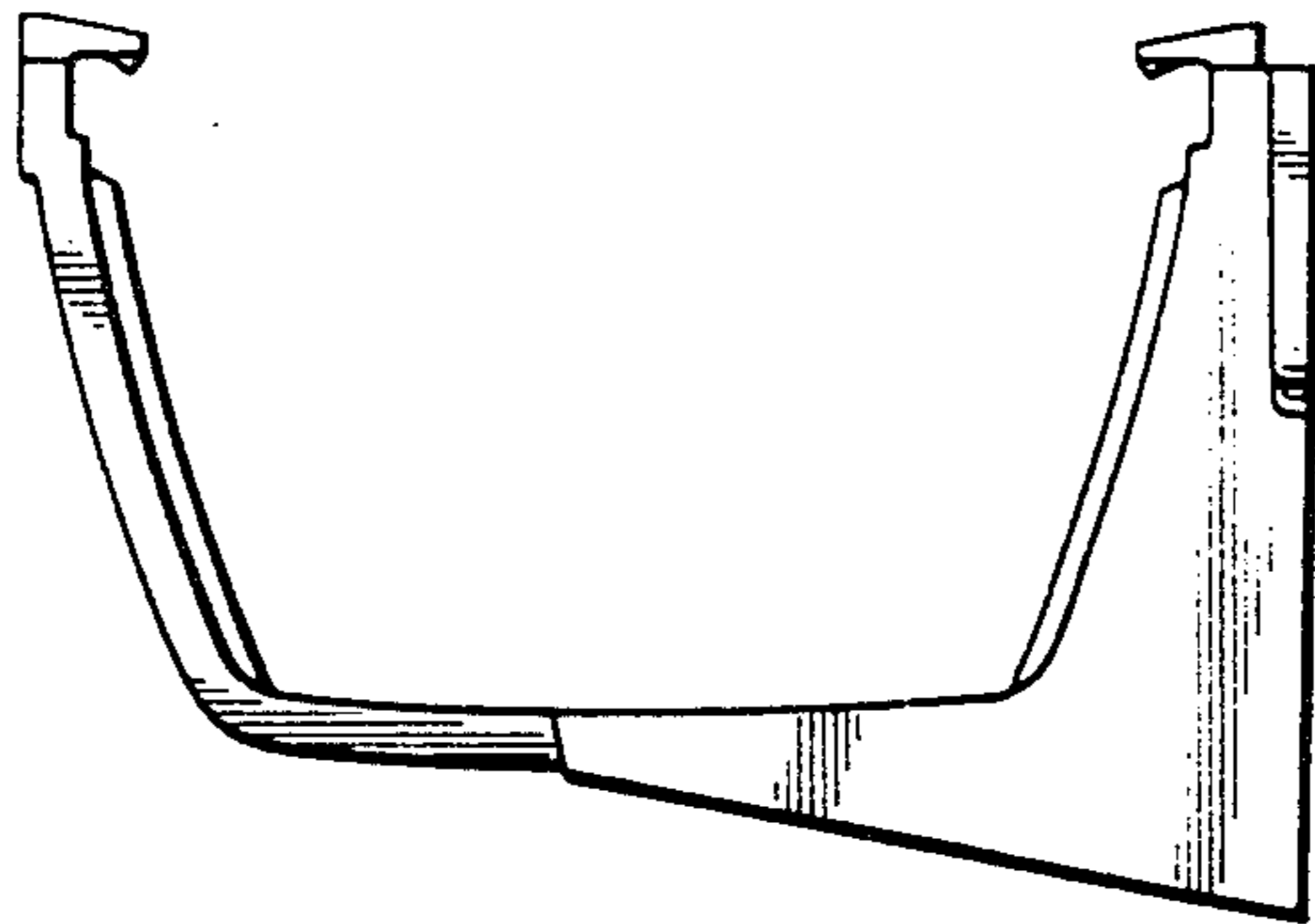

FIG. 6

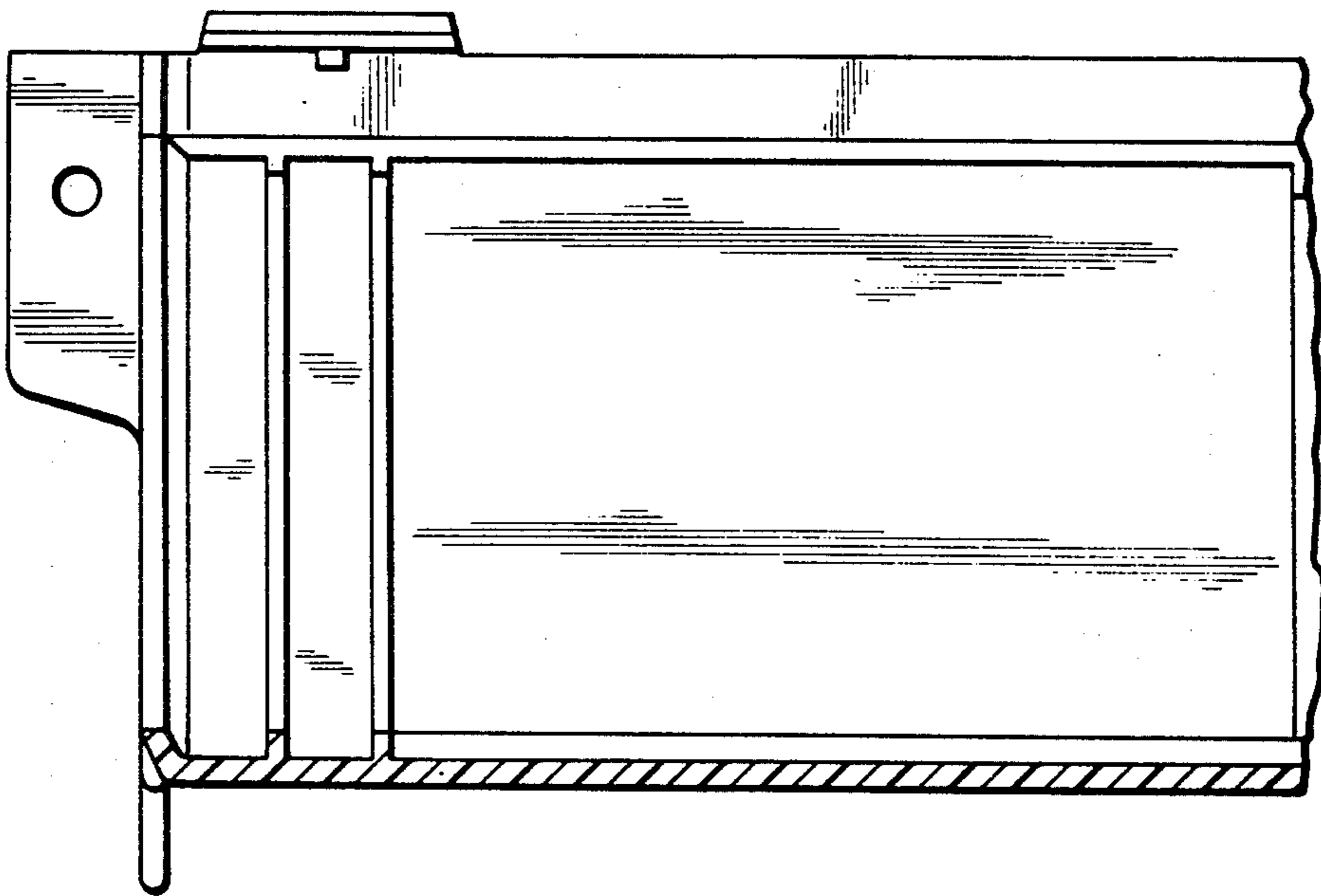

FIG. 7

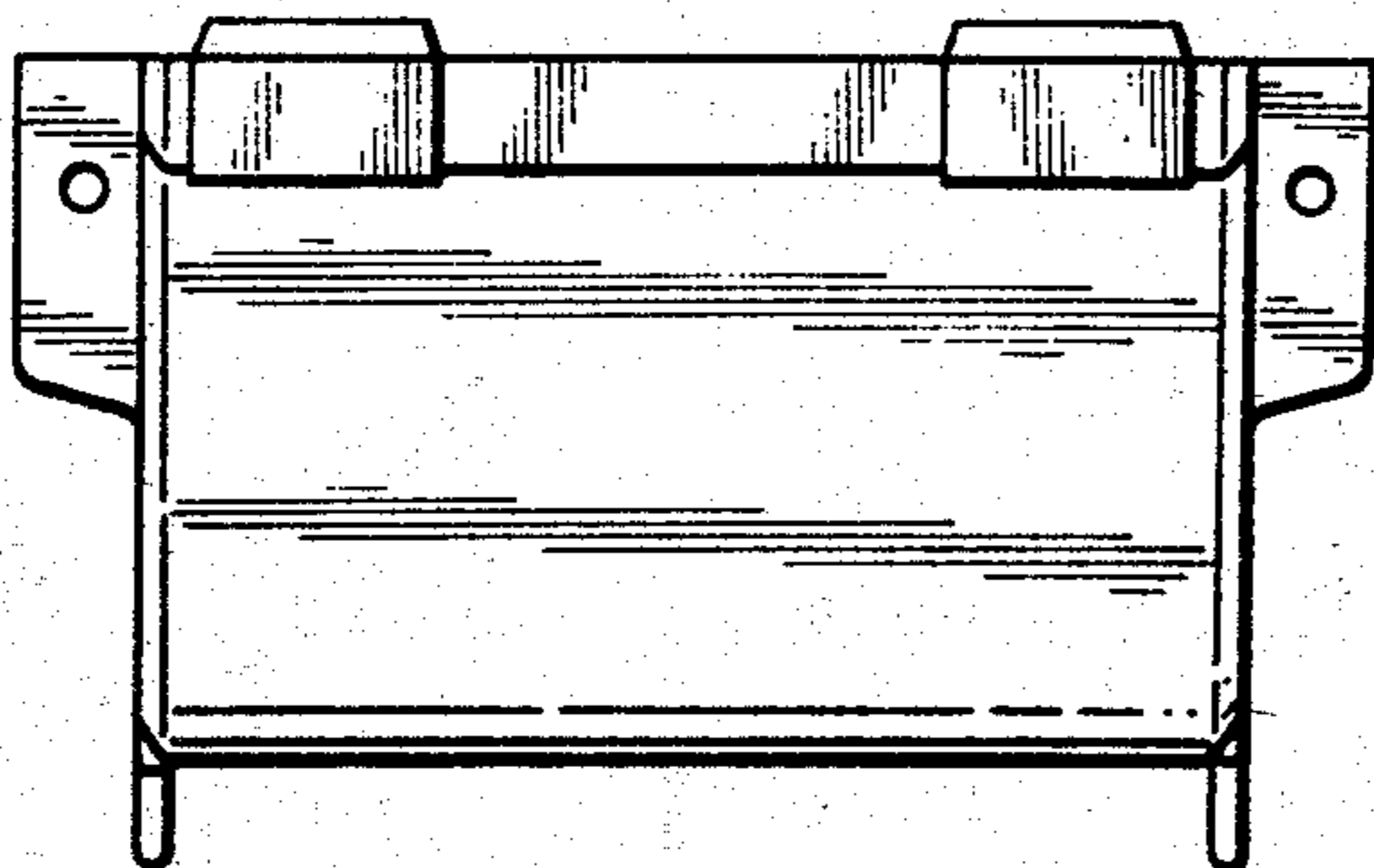

FIG. 8

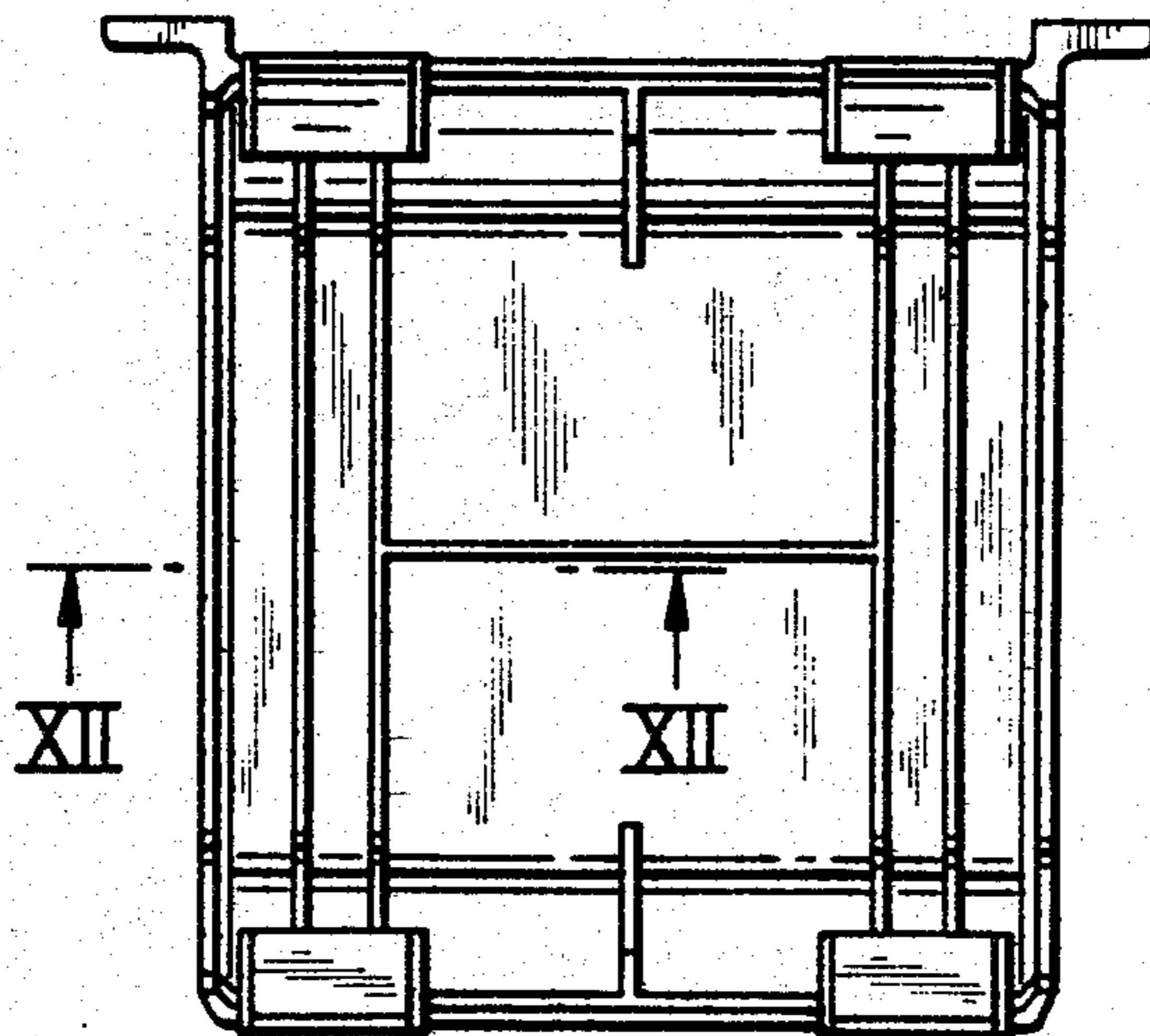

FIG. 9

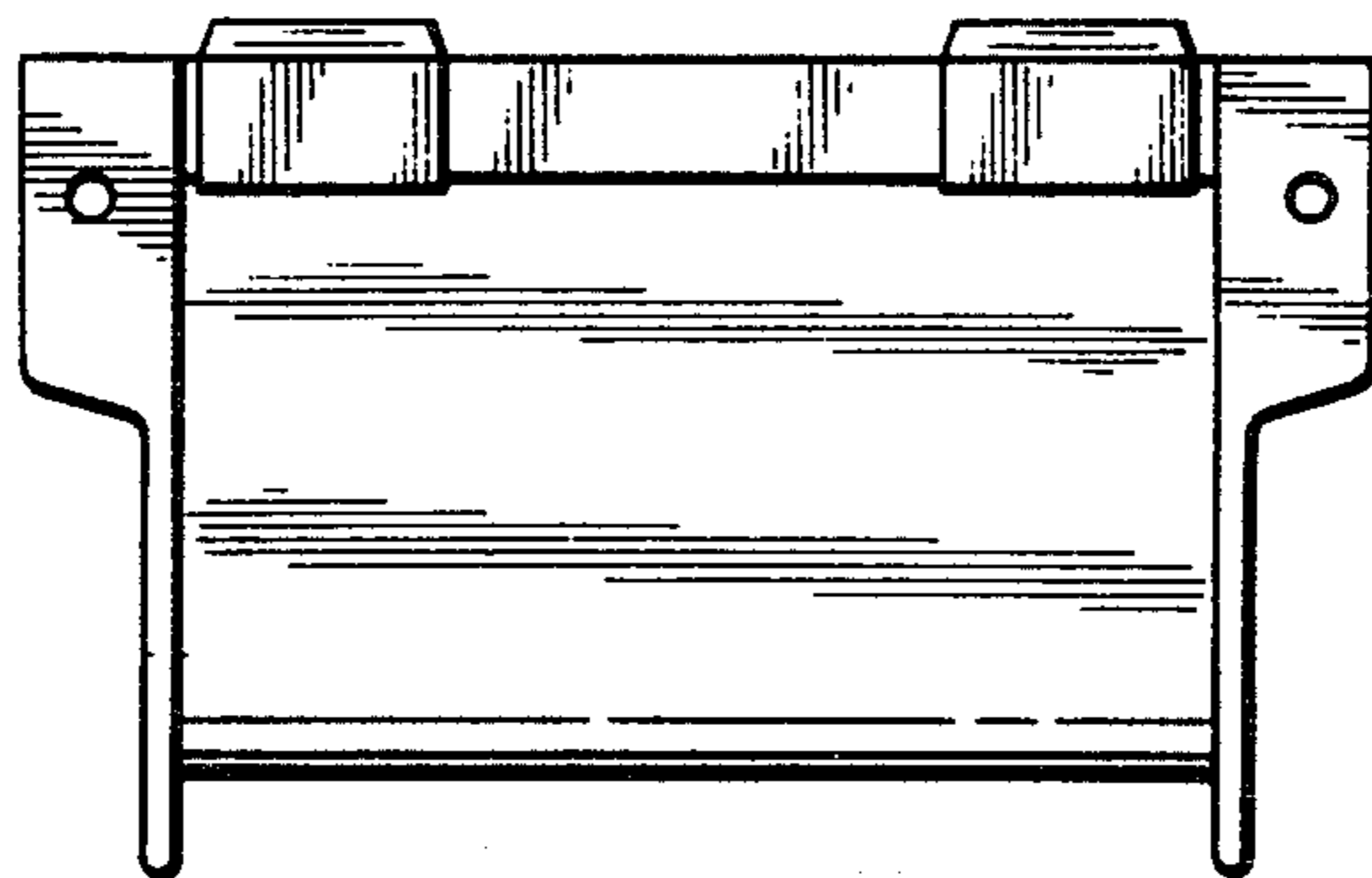

FIG. 10

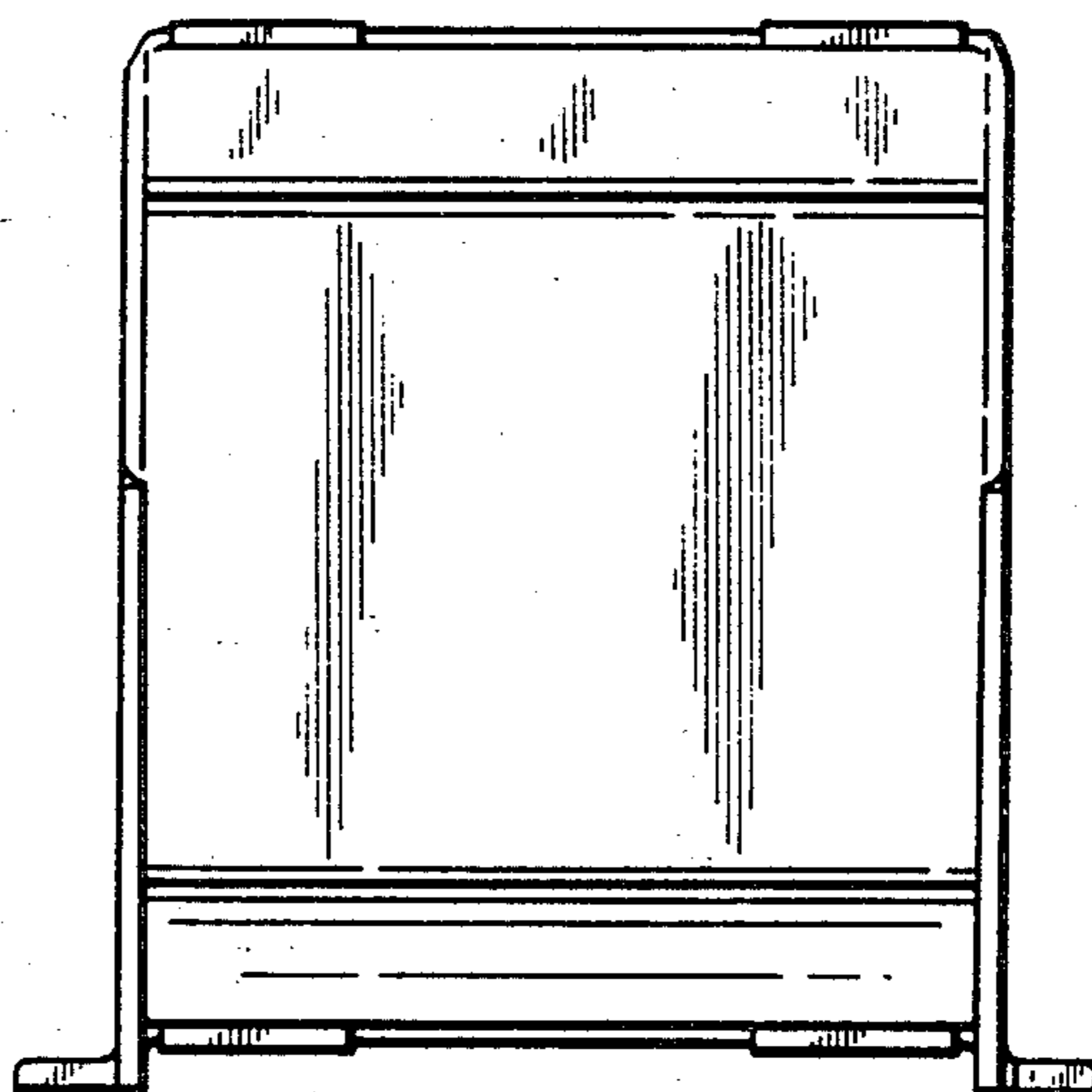

FIG. 11

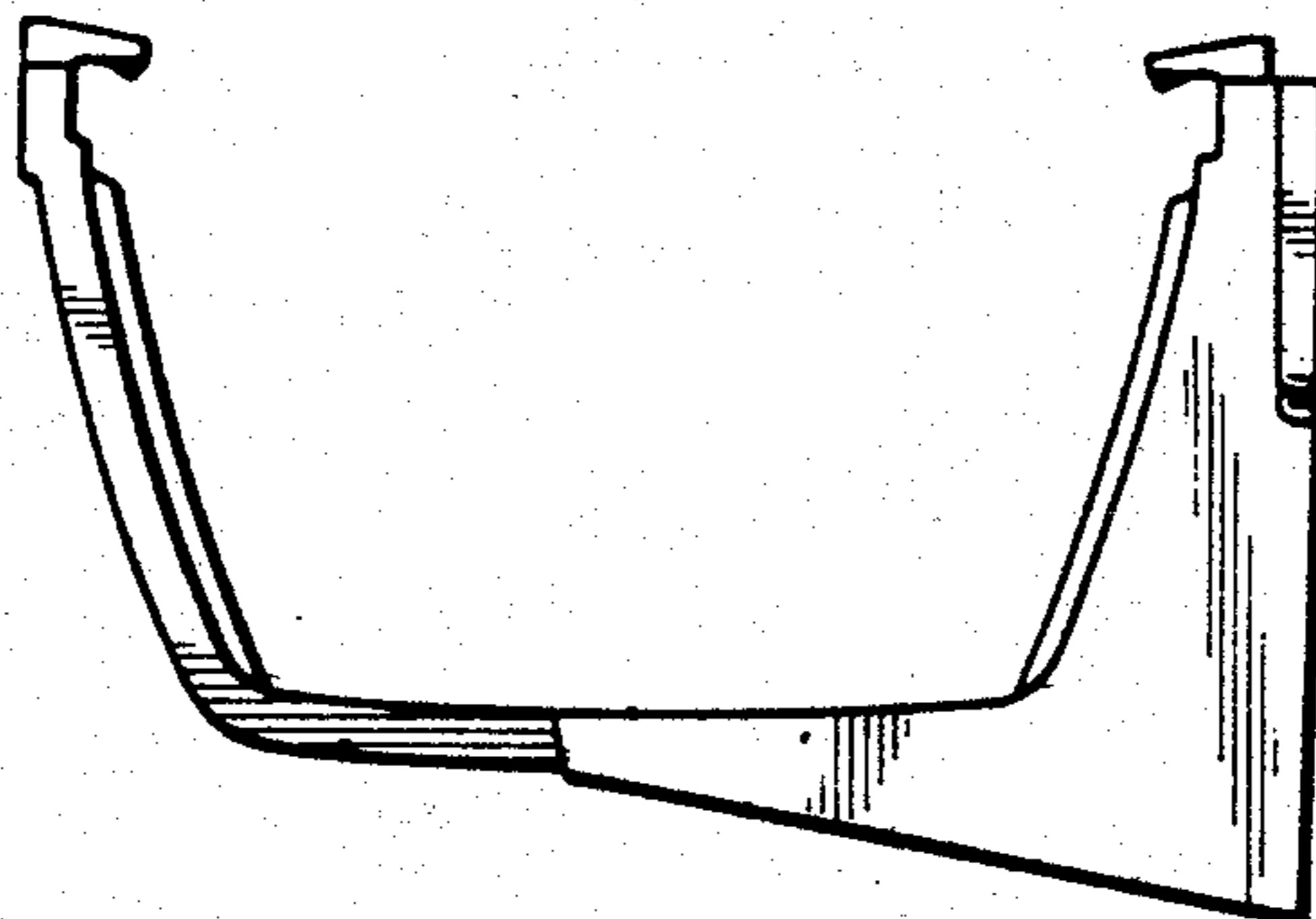

FIG. 12

