

[54] **HANGING CARRIER**

[76] **Inventor: Ken J. McBean, 204 - 2090 Comox Street, Vancouver, British Columbia, Canada, V6G 1R9**

[**] **Term: 14 Years**

[21] **Appl. No.: 674,293**

[22] **Filed: Nov. 23, 1984**

[52] **U.S. Cl. D6/513**

[58] **Field of Search D6/403, 404, 405, 513, D6/556, 557, 558; 211/86, 113, 118, 119, 74, 71; 248/27.8; 47/66, 67**

[56] **References Cited**

U.S. PATENT DOCUMENTS

- D. 160,781 11/1950 Giese 47/67
- D. 235,601 1/1975 Lewis 47/67
- D. 255,850 7/1980 Geyer D6/513

D. 256,073 7/1980 Caroe et al. D6/513

Primary Examiner—B. J. Bullock
Assistant Examiner—Suzanne N. Gitlin
Attorney, Agent, or Firm—Fetherstonhaugh & Co.

[57] **CLAIM**

The ornamental design for a hanging carrier, substantially as shown and described.

DESCRIPTION

FIG. 1 is a perspective view, showing my new design; FIG. 2 is a top plan view thereof; FIG. 3 is a side elevational view taken from the right of FIG. 1; FIG. 4 is a side elevational view taken from the left of FIG. 1; FIG. 5 is a front elevational view thereof; FIG. 6 is a rear elevational view thereof; FIG. 7 is a bottom plan view thereof.

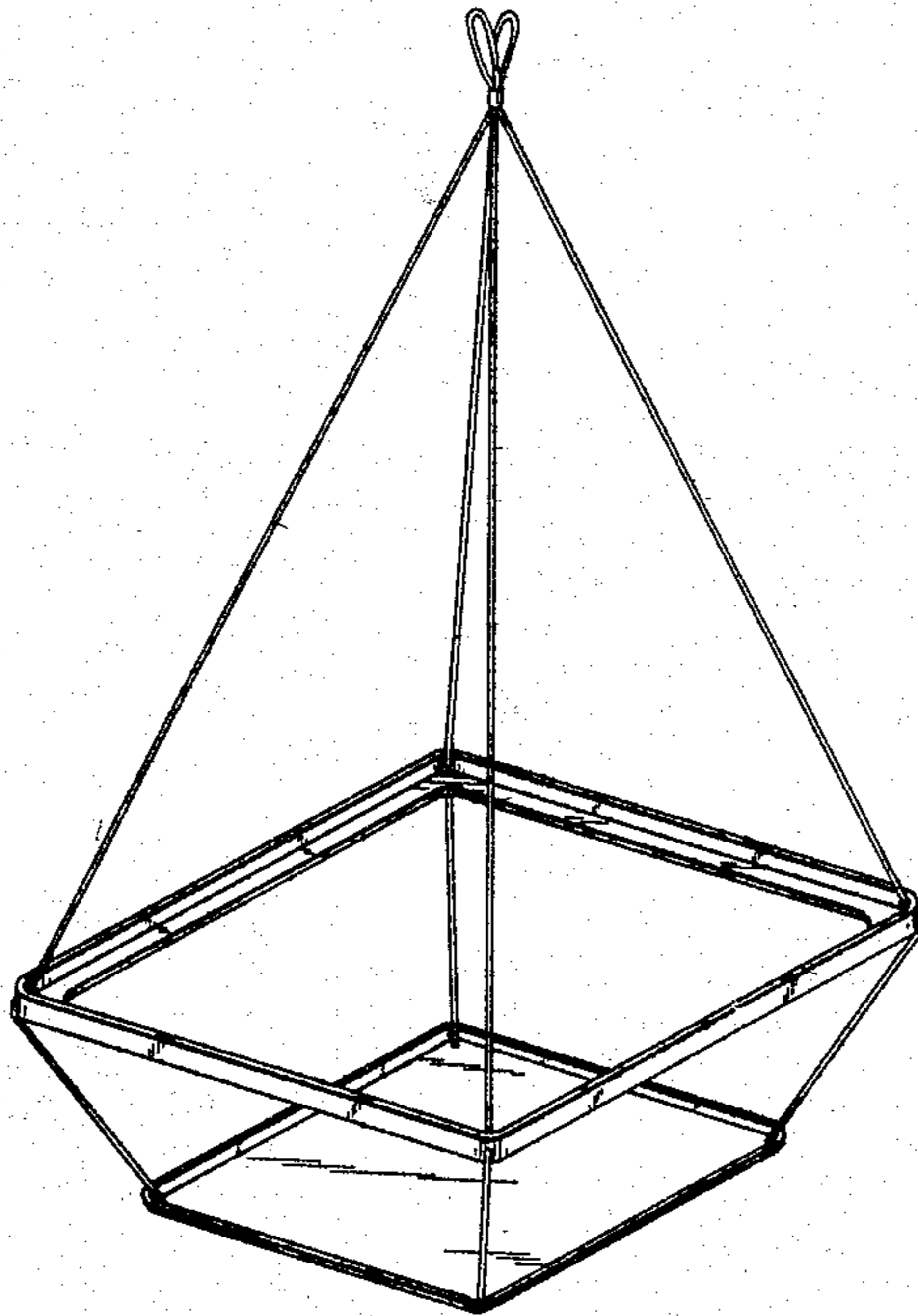

Fig. 1.

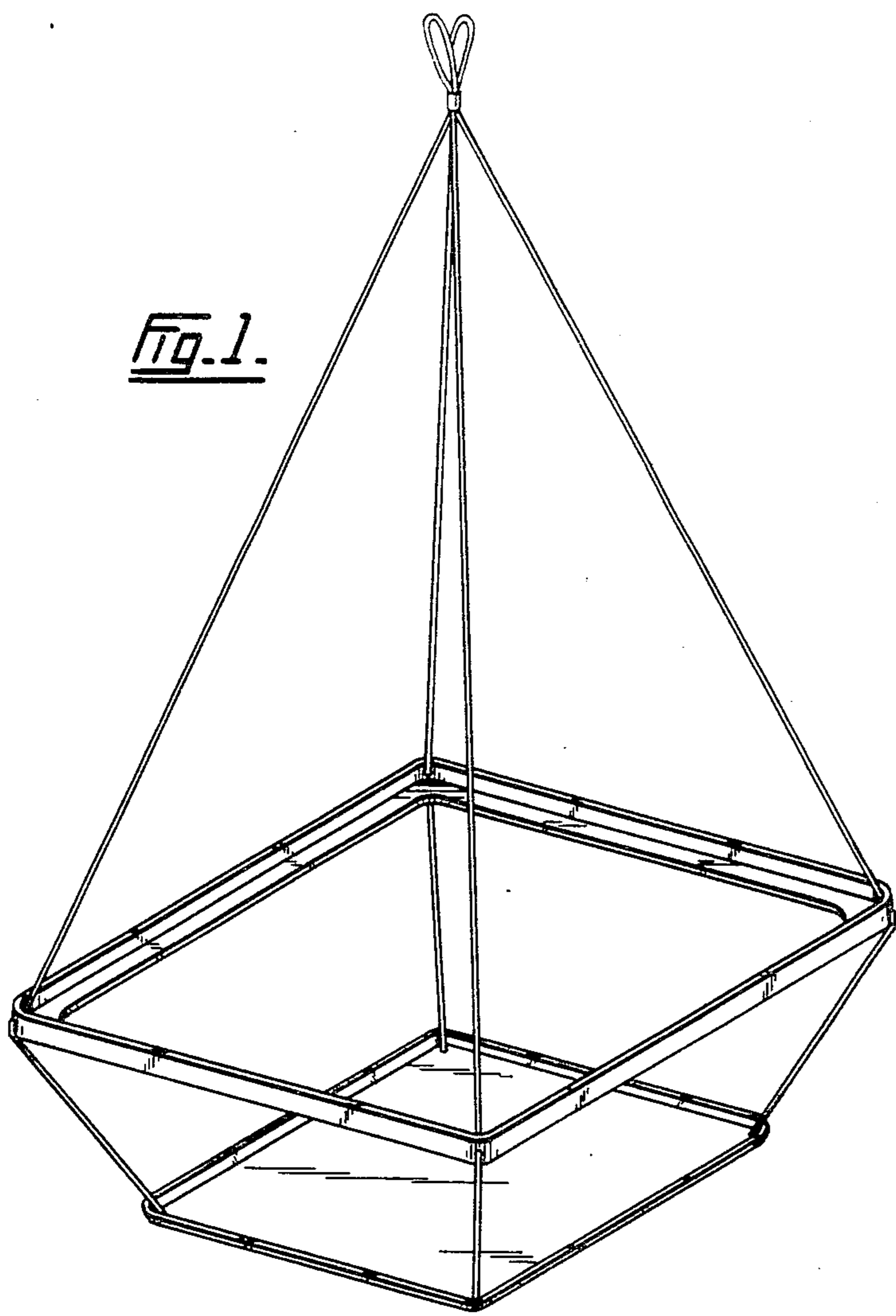

Fig. 3.

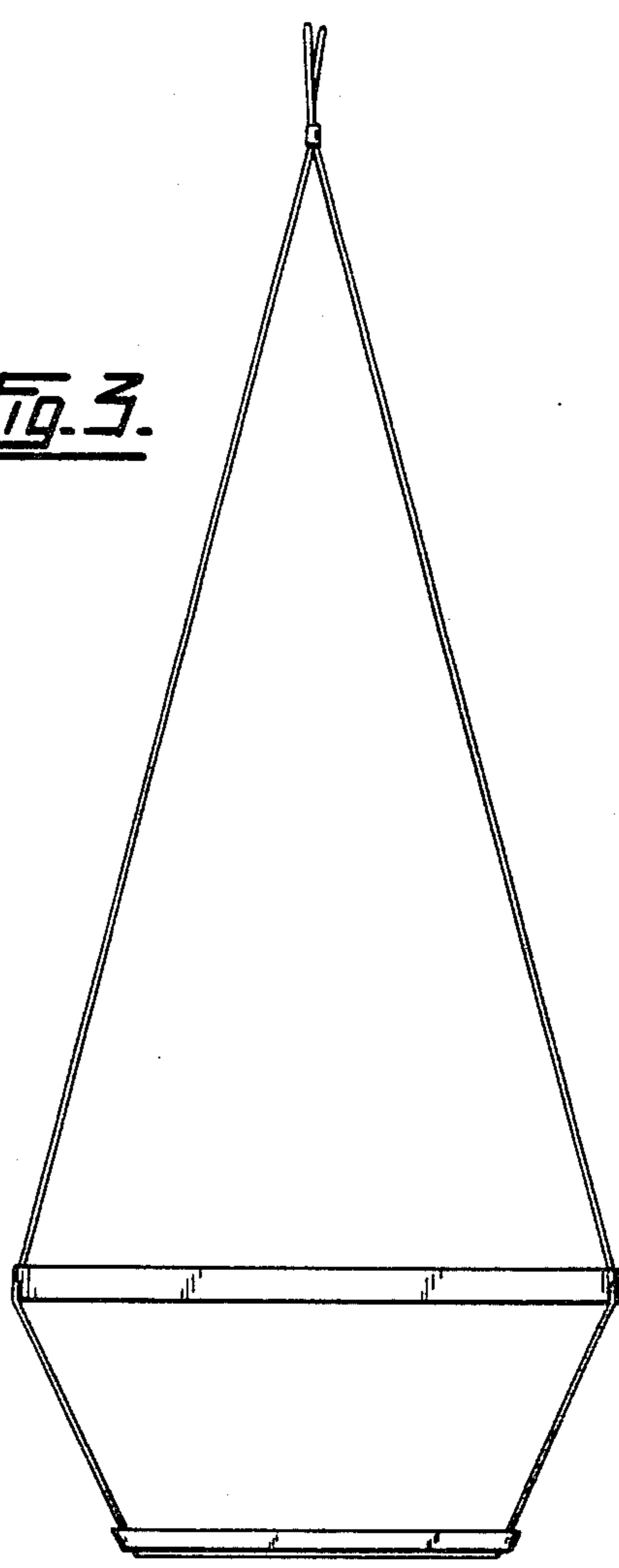

Fig. 2.

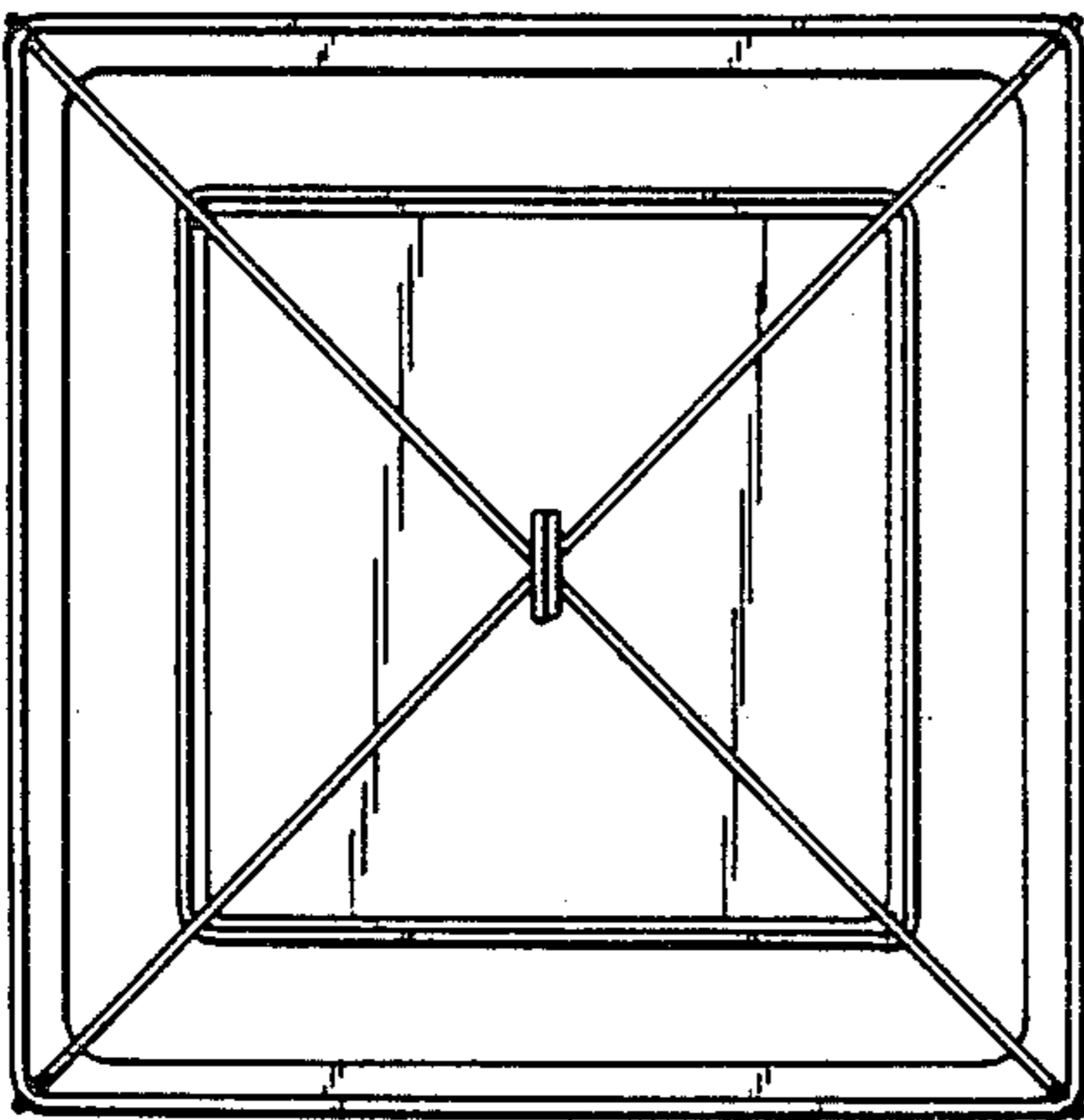

Fig. 7.

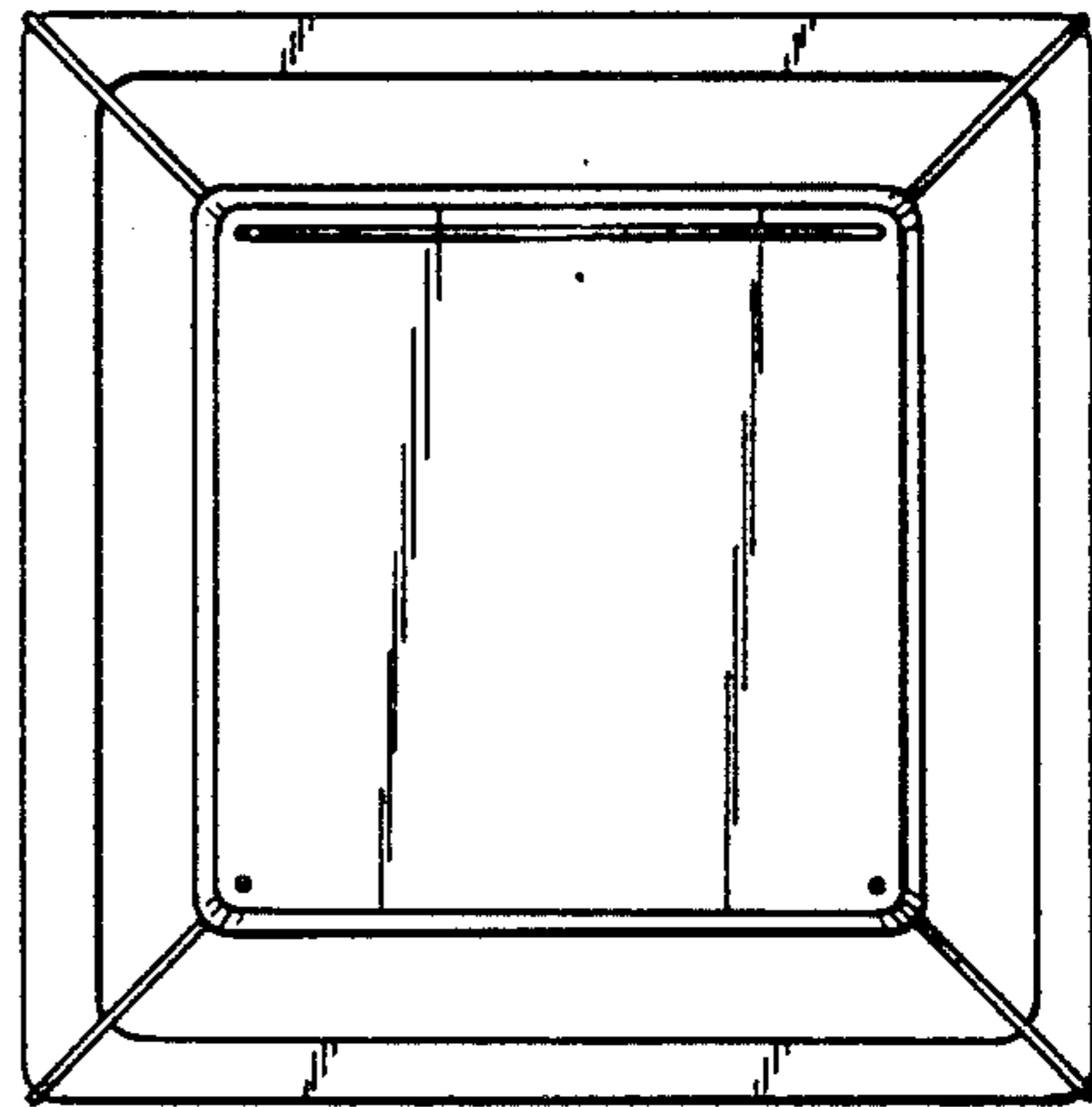

Fig. 4.

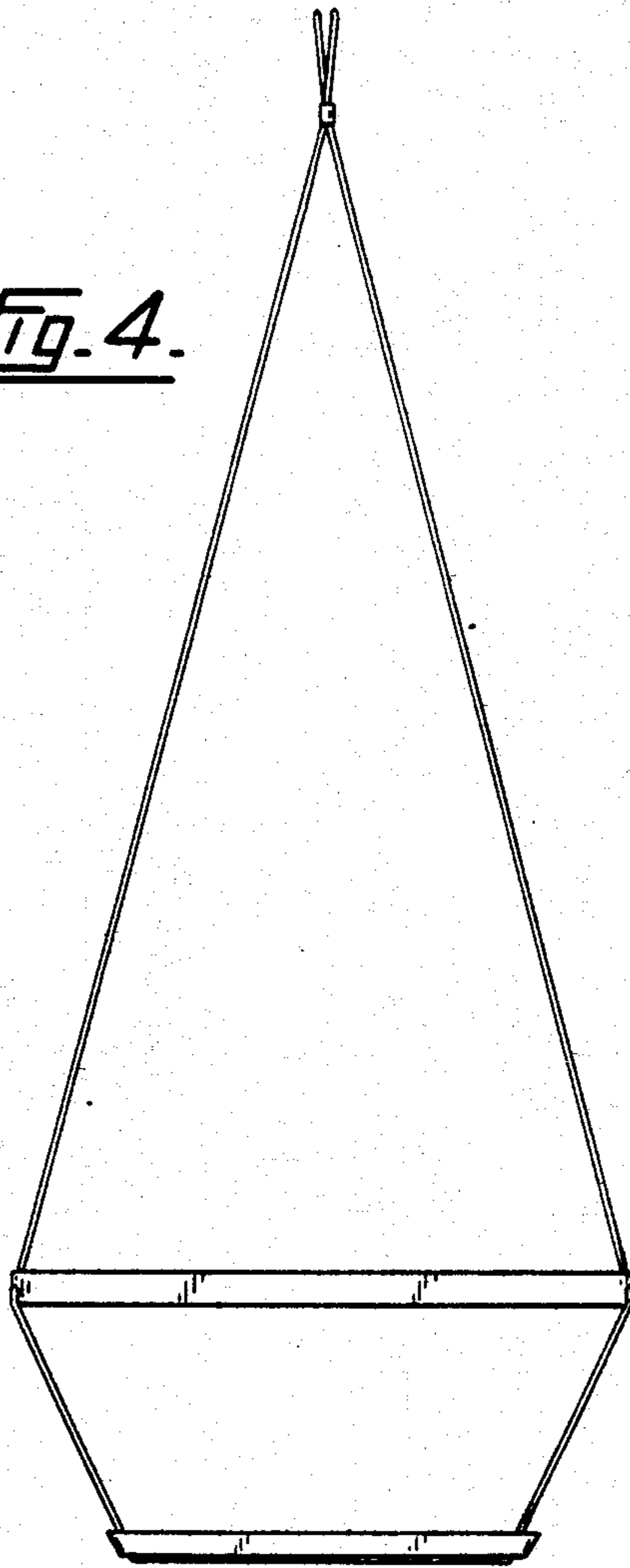

Fig. 5.

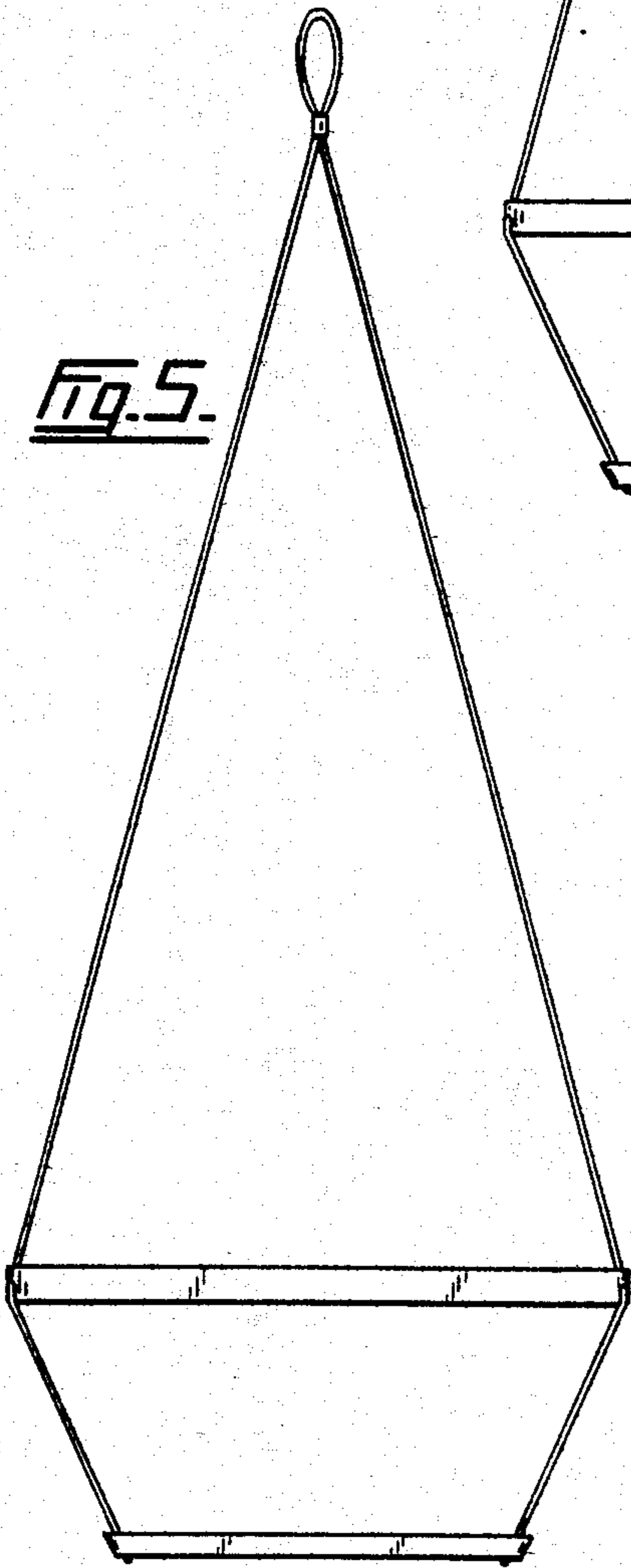

Fig. 6.

