

United States Patent [19]

Eguchi et al.

[11] Patent Number: **Des. 285,571**

[45] Date of Patent: **** Sep. 9, 1986**

[54] SEWING MACHINE

[75] Inventors: **Yoshiaki Eguchi; Koji Uchida**, both of Higashimurayama, Japan

[73] Assignee: **Janome Sewing Machine Co., Ltd.**, Tokyo, Japan

[**] Term: **14 Years**

[21] Appl. No.: **522,843**

[22] Filed: **Aug. 12, 1983**

[30] Foreign Application Priority Data

Mar. 12, 1983 [JP] Japan 58-9976

[52] U.S. Cl. **D15/69**

[58] Field of Search **D15/68-70;**
112/63, 258-261

[56] References Cited

U.S. PATENT DOCUMENTS

D. 253,705 12/1979 Felix et al. D15/69
D. 266,519 10/1982 Genaro et al. D15/68
D. 276,345 11/1984 Yoneda D15/70
3,570,431 3/1971 Fresard 112/63 X

3,995,573 12/1976 Nishigami et al. 112/258
4,055,131 10/1977 O'Brien et al. 112/258 X
4,434,736 3/1984 Szostak et al. 112/258

OTHER PUBLICATIONS

Good Housekeeping 4-77, p. 11, The Kenmore Sewing Machine.

Primary Examiner—Bernard Ansher

Assistant Examiner—Linda Titolo

Attorney, Agent, or Firm—Michael J. Striker

[57] CLAIM

The ornamental design for a sewing machine, substantially as shown and described.

DESCRIPTION

FIG. 1 is a front elevational view of a sewing machine showing our new design;

FIG. 2 is a right side elevational view thereof;

FIG. 3 is a left side elevational view thereof;

FIG. 4 is a top plan view thereof;

FIG. 5 is a bottom plan view thereof;

FIG. 6 is a rear elevational view thereof; and

FIG. 7 is a top front perspective view thereof.

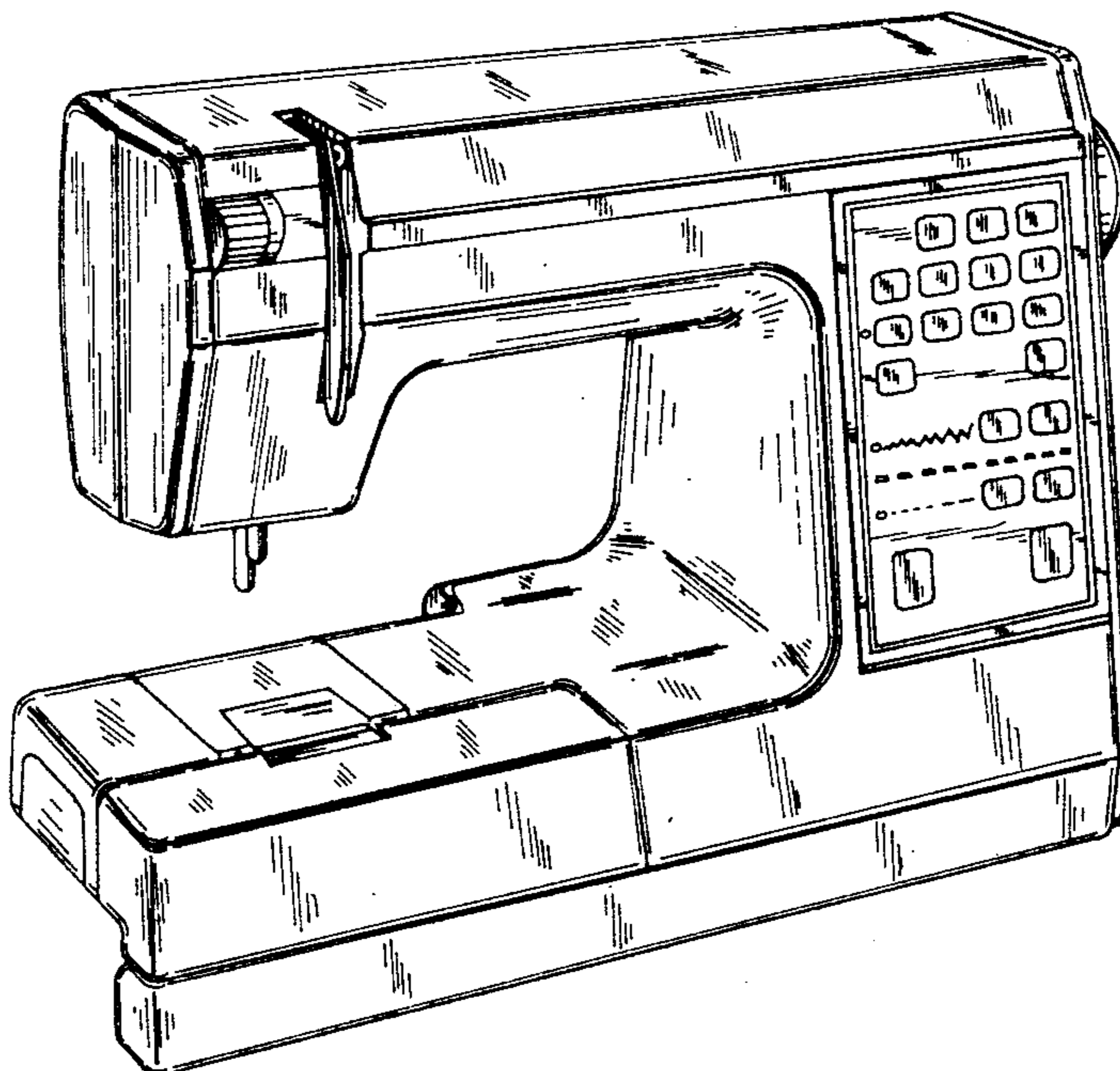

FIG. 1

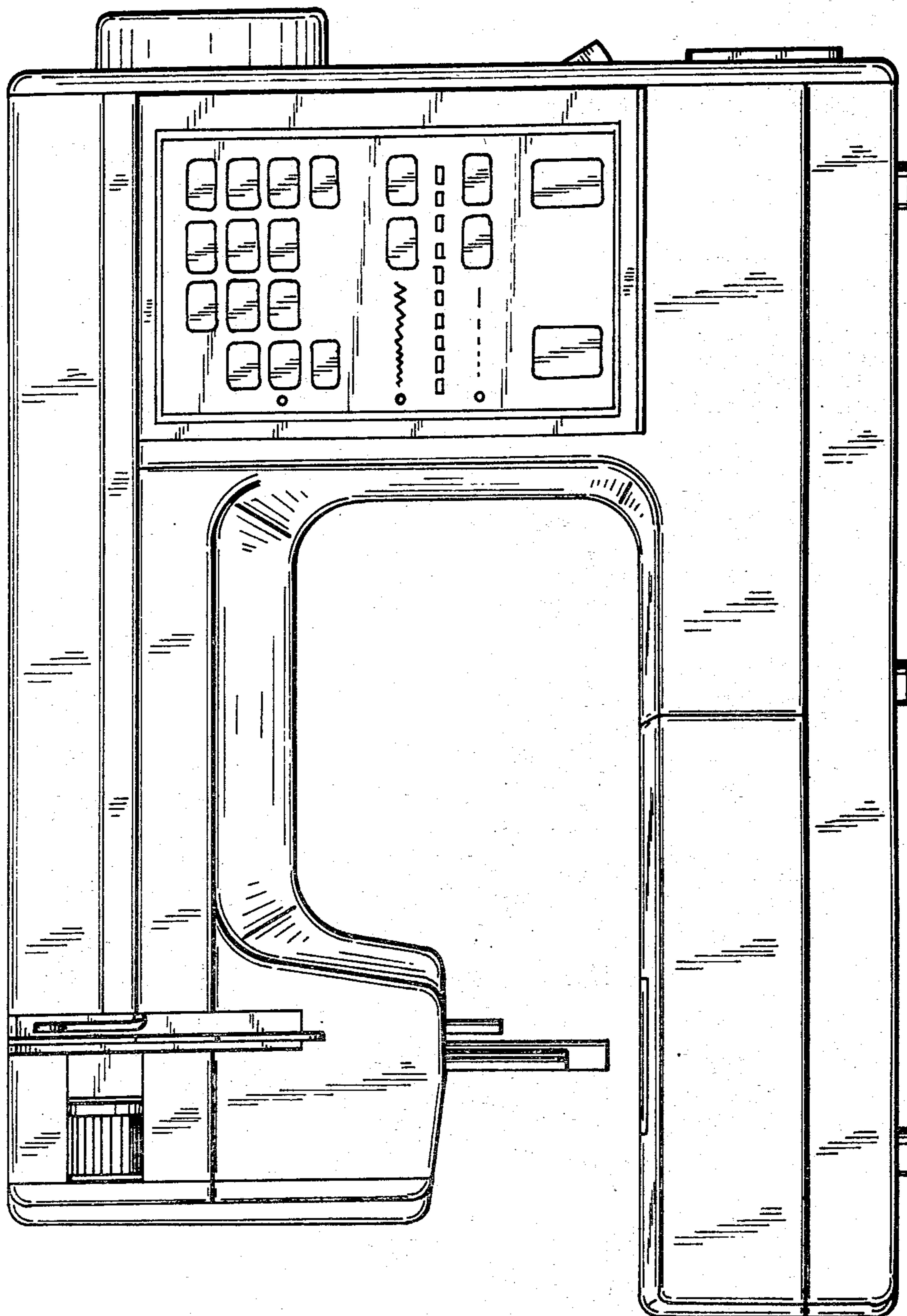

FIG. 2

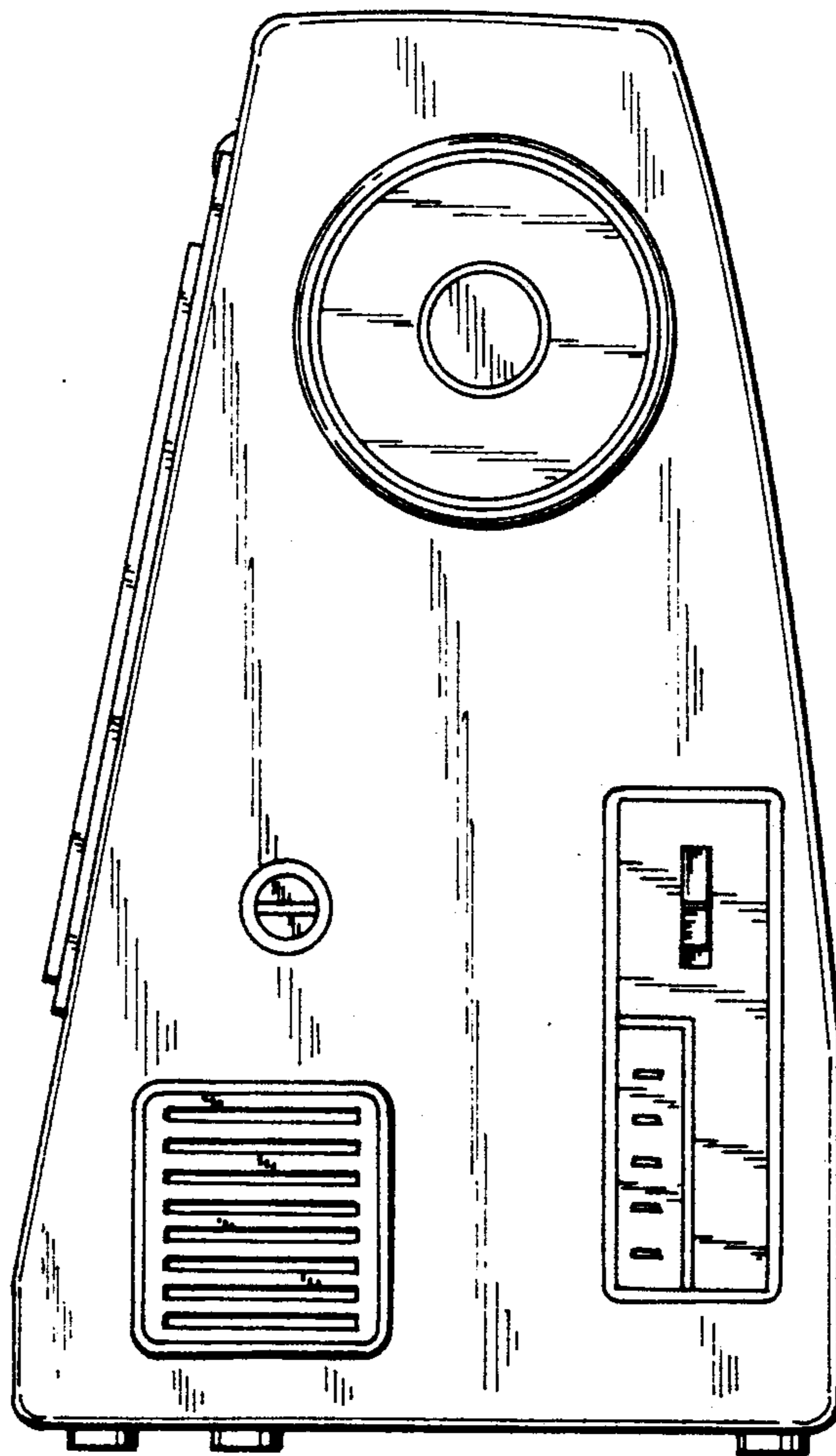

FIG. 3

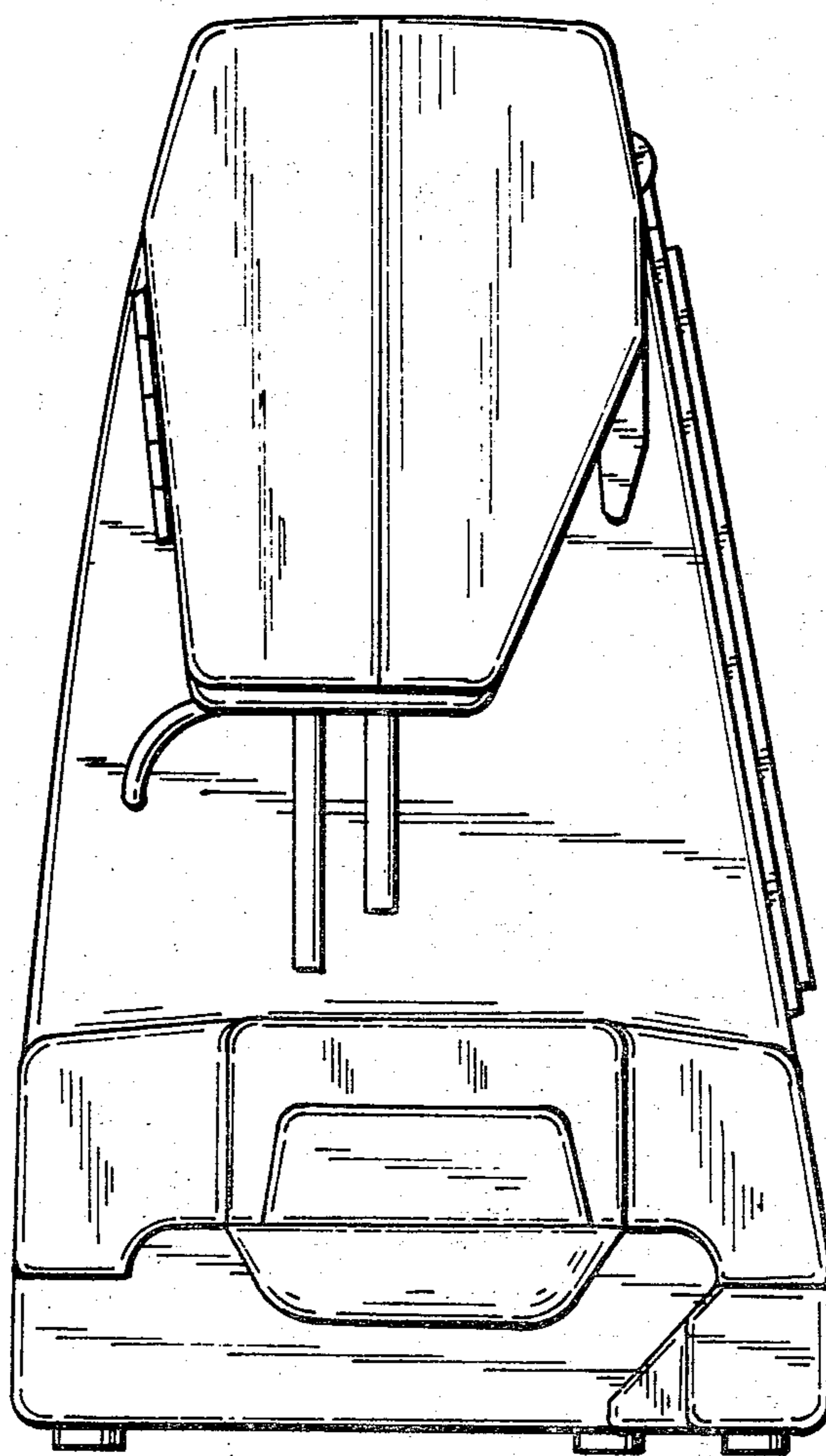

FIG. 4

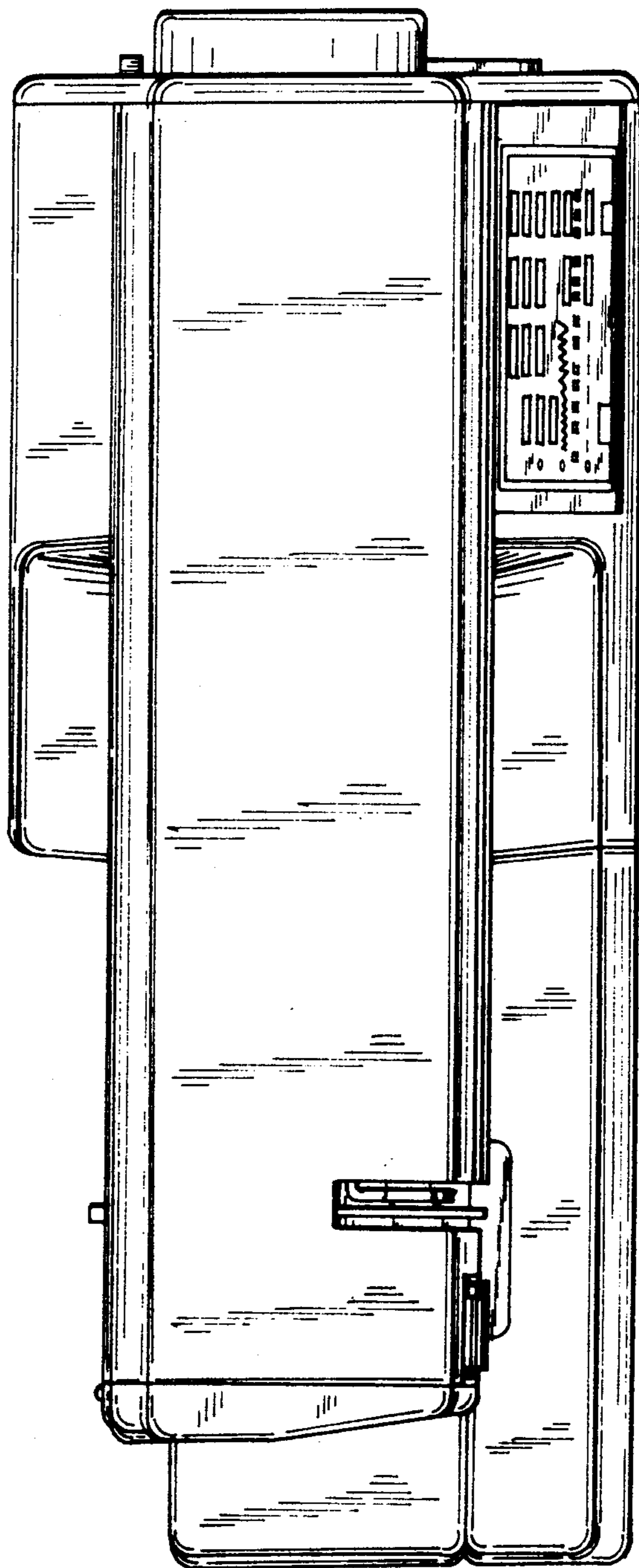

FIG. 5

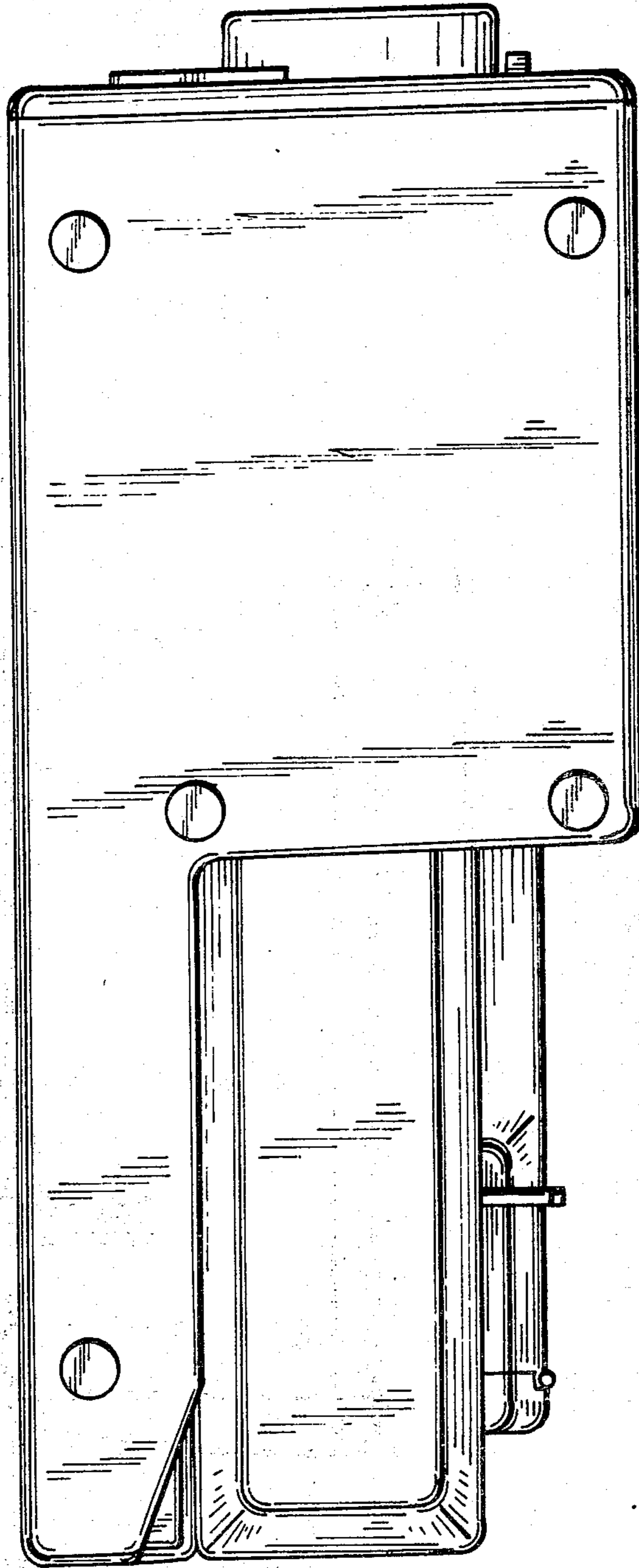

FIG. 6

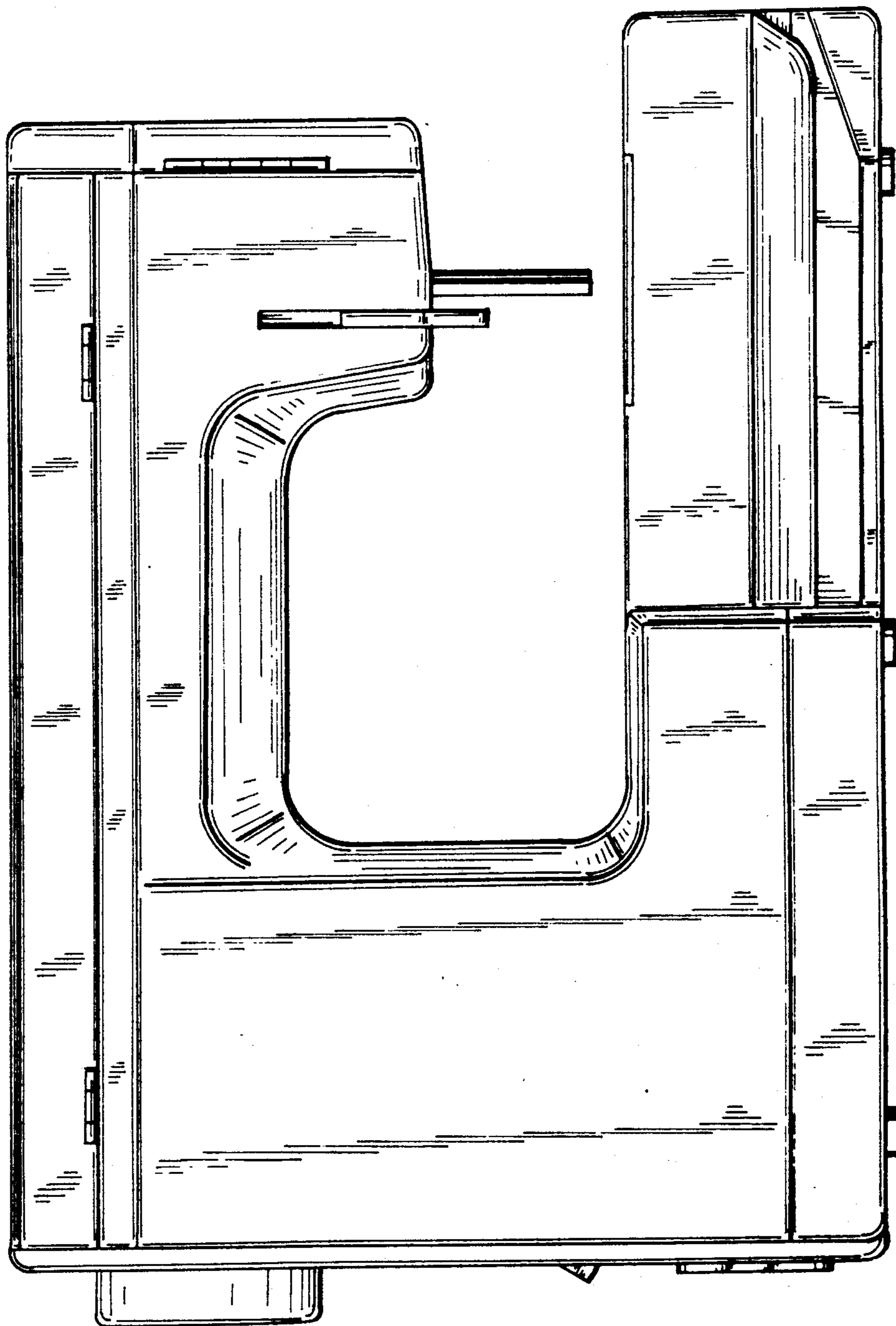

FIG. 7

