

[54] **UNIT FOR RESETTING OR PRESETTING A
REMOTE METER DISPLAY**

[75] **Inventor: Irwin A. Hicks, Radnor, Pa.**

[73] **Assignee: American Meter Company,
Philadelphia, Pa.**

[**] **Term: 14 Years**

[21] **Appl. No.: 620,990**

[22] **Filed: Jun. 15, 1984**

[52] **U.S. Cl. D13/12**

[58] **Field of Search** D13/2-3,
D13/11-13, 32, 35, 38, 40-41; D24/8, 17, 23,
26, 29, 36, 99; D10/5, 46, 75, 81, 104, 106, 121;
D18/1, 6, 7; D14/1-3, 6, 52, 92, 99;
340/870.02, 825.6; 335/281; 361/331-332, 334,
346-348, 350, 356, 358, 366, 380, 390, 392, 394;
174/50, 52 R; 307/24, 31; 200/293-294,
296-297, 308, 329, 331, 333, 340; 220/3.2-3.3,
3.8-3.9, 400; 128/419 R; 364/700, 706, 708,
900; 235/66

[56] **References Cited**

U.S. PATENT DOCUMENTS

D. 224,712 9/1972 Van de Poel D14/3
D. 247,434 3/1978 Hampf D14/52
D. 257,560 11/1980 Jang D13/12
D. 263,300 3/1982 Waagen D14/6

Primary Examiner—Catherine E. Kemper
Assistant Examiner—Ruth E. Takemoto
Attorney, Agent, or Firm—David L. Davis; Robert E.
Smith; Edward L. Bell

[57] **CLAIM**

The ornamental design for a unit for resetting or pre-
setting a remote meter display, substantially as shown and
described.

DESCRIPTION

FIG. 1 is a front perspective view of a unit for resetting
or presetting a remote meter display showing my new
design;
FIG. 2 is a rear perspective view thereof;
FIG. 3 is a front elevational view thereof;
FIG. 4 is a right side elevational view thereof;
FIG. 5 is a top plan view thereof;
FIG. 6 is a rear elevational view thereof;
FIG. 7 is a left side elevational view thereof;
FIG. 8 is a bottom plan view of the unit.

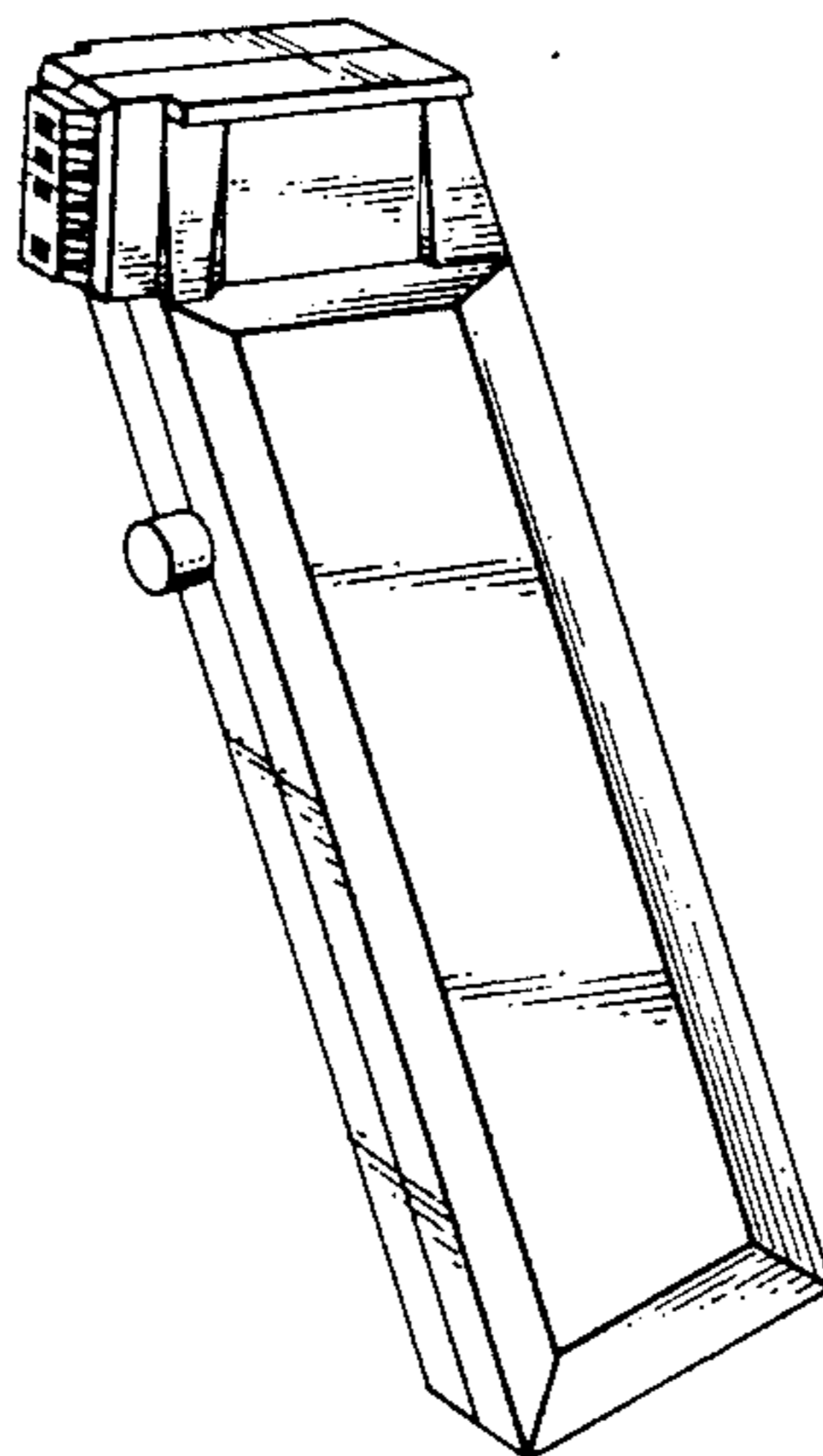

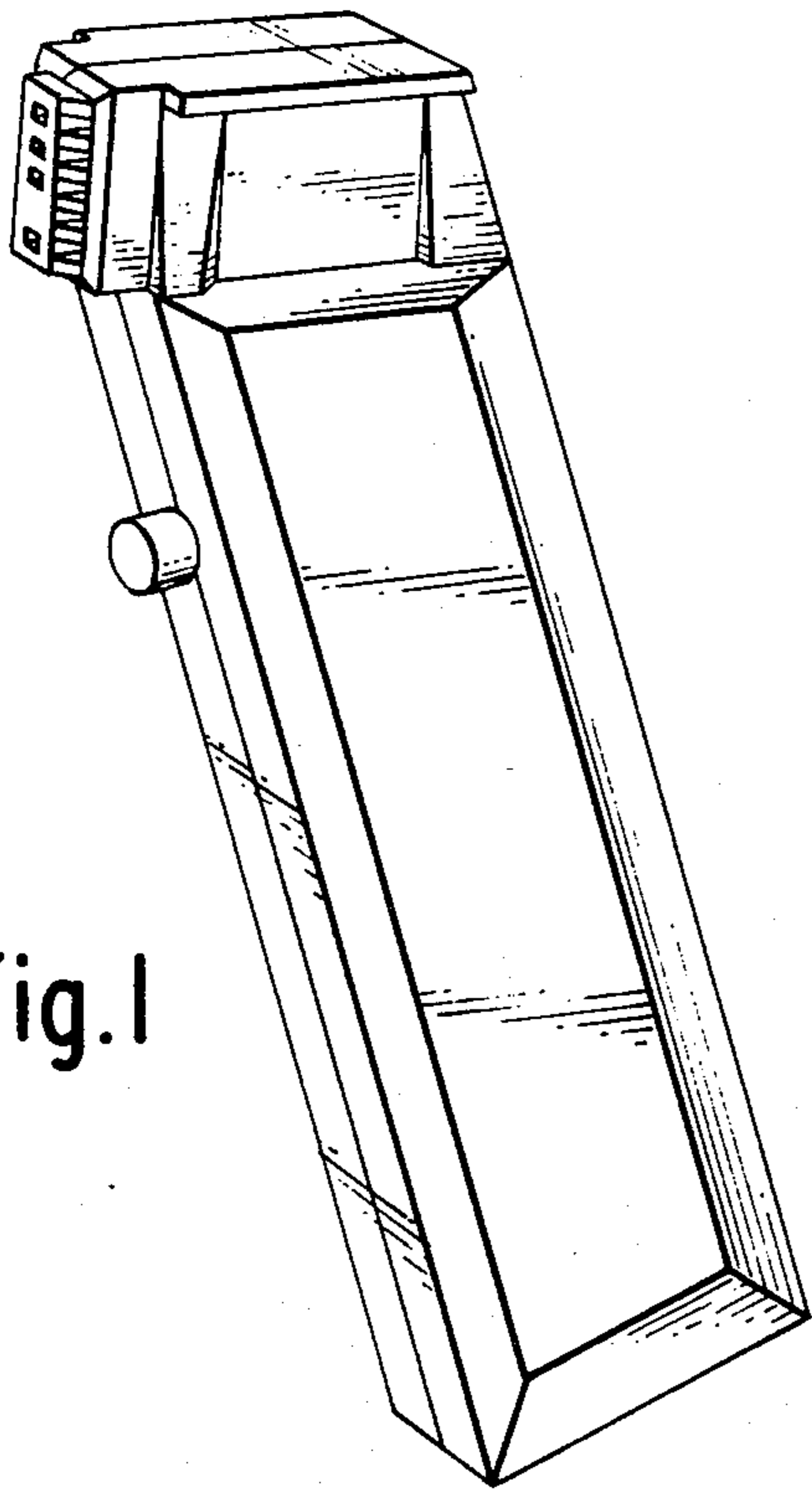

Fig. 1

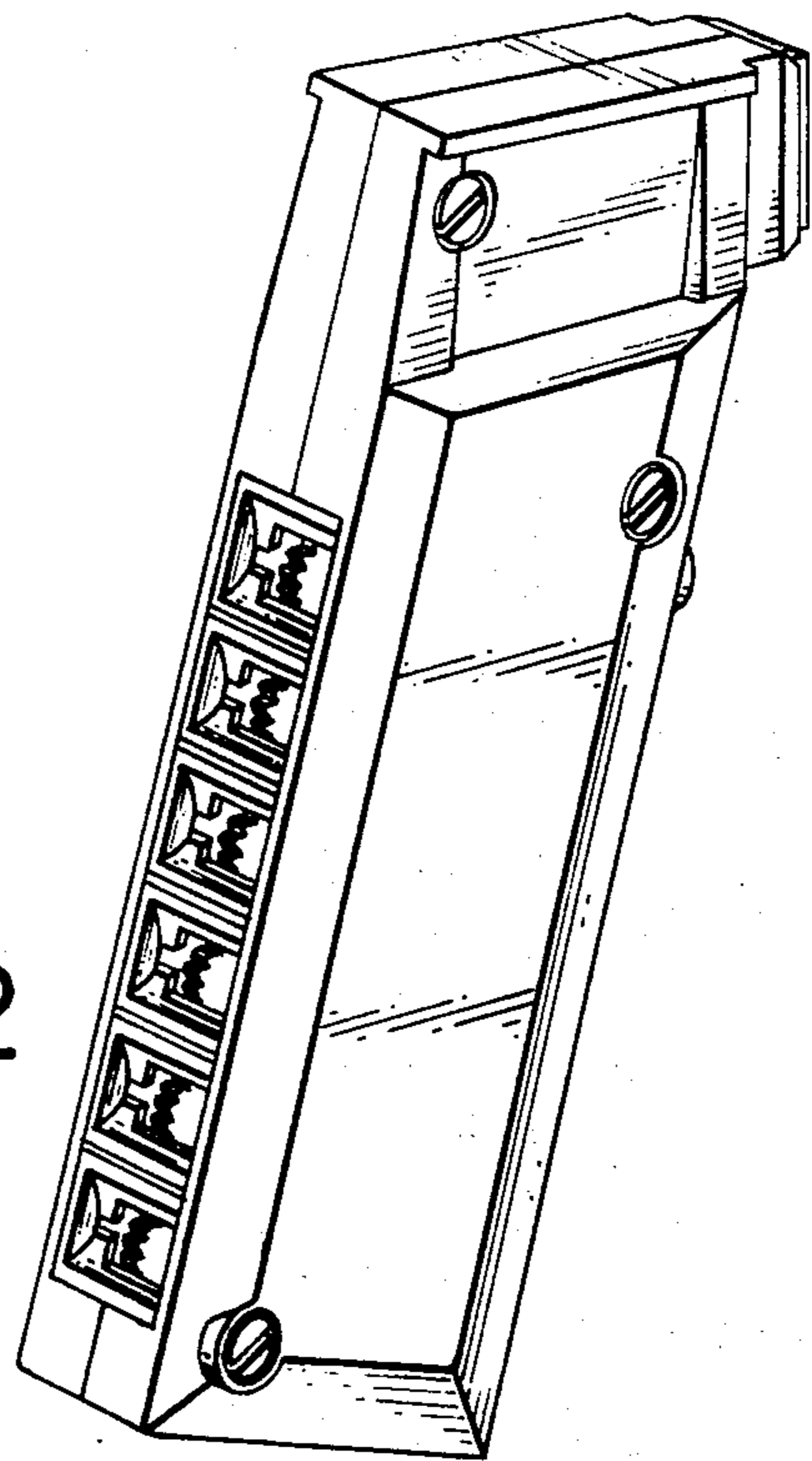

Fig. 2

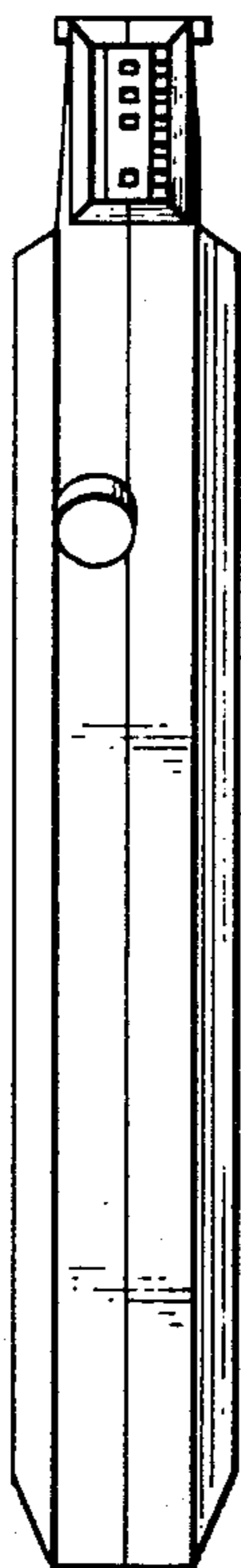

Fig. 3

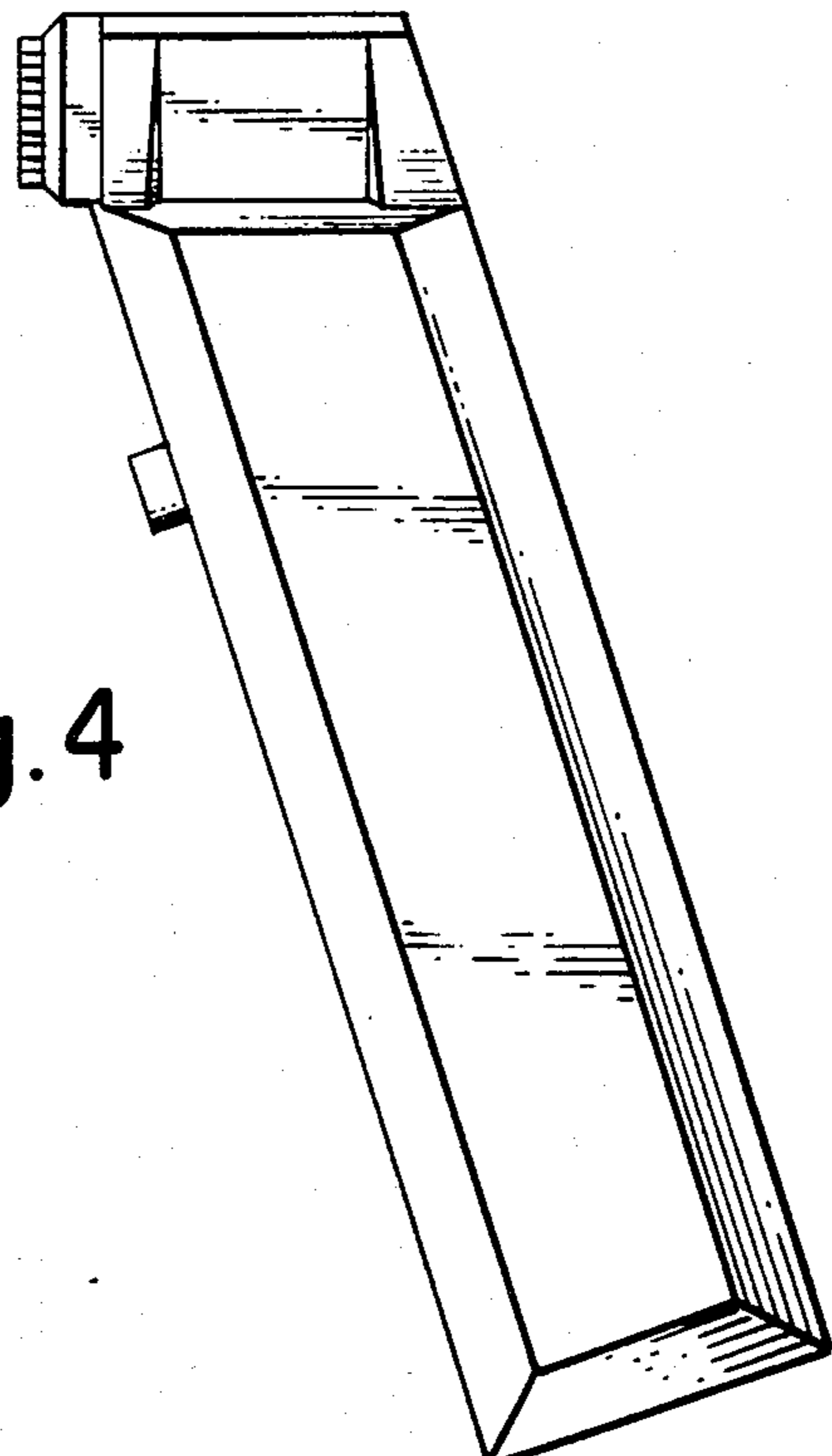

Fig. 4

Fig.5

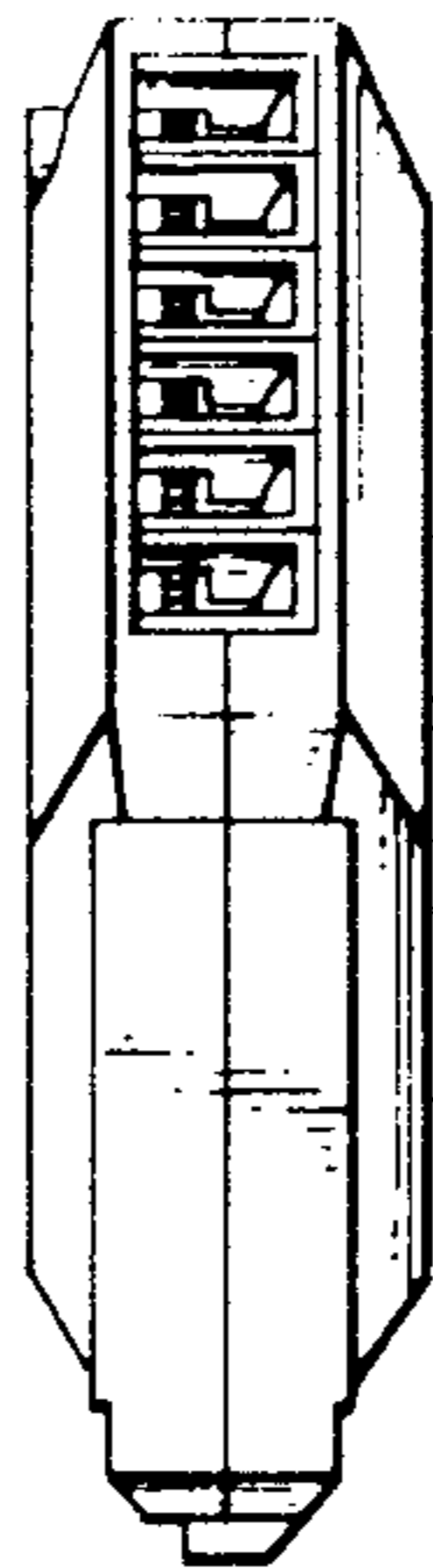

Fig.6

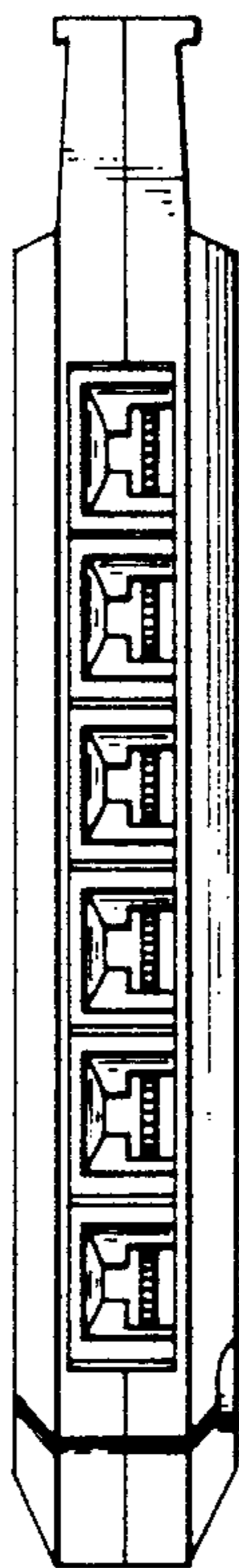

Fig.7

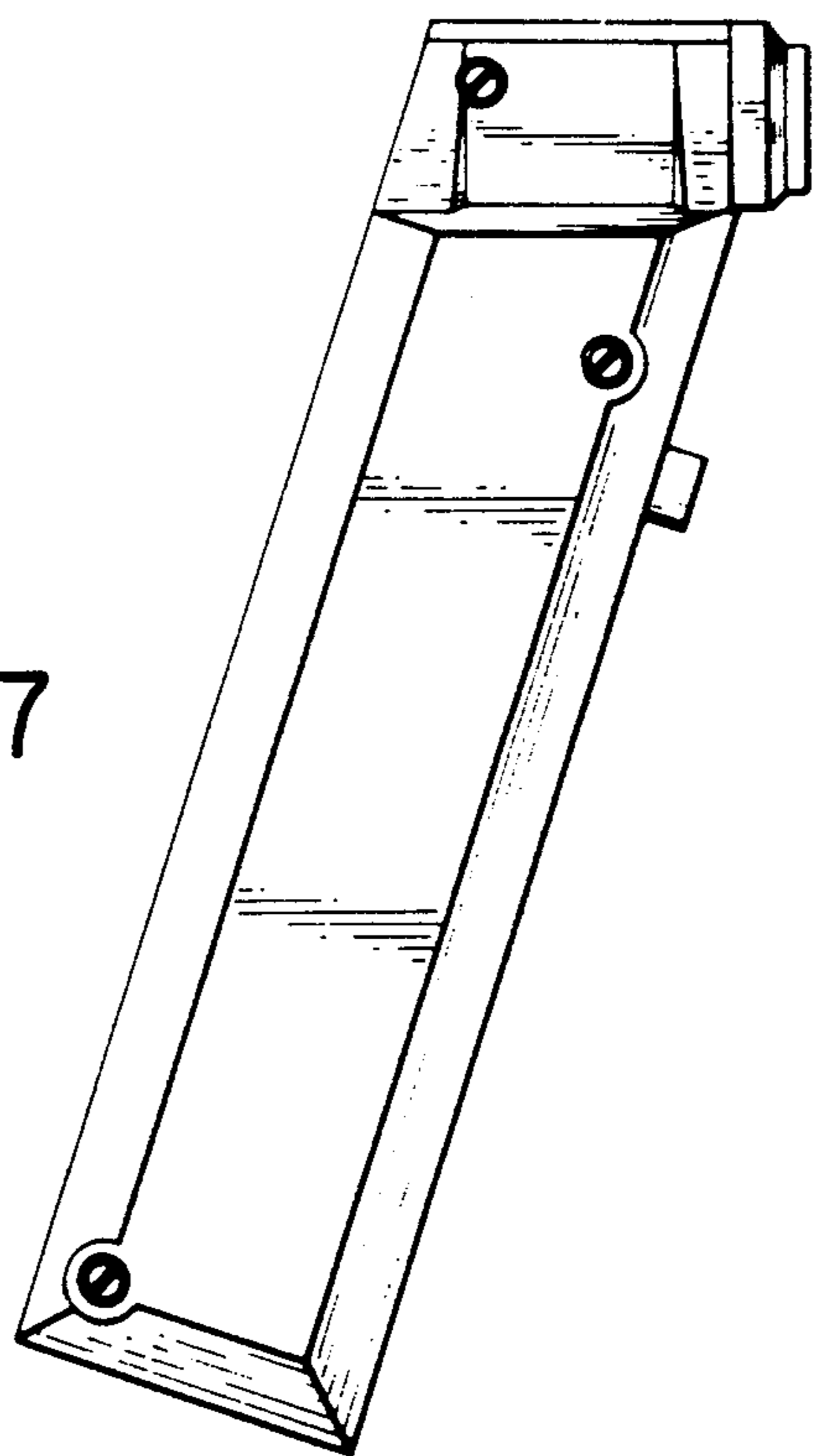

Fig.8

