

[54] LID FOR A CONTAINER

[75] Inventors: William A. Dart; Kenneth B. Dart, both of Okemos, Mich.

[73] Assignee: Dart Container Corporation, Mason, Mich.

[\*] Notice: The portion of the term of this patent subsequent to Aug. 7, 1998 has been disclaimed.

[\*\*] Term: 14 Years

[21] Appl. No.: 547,020

[22] Filed: Oct. 31, 1983

[52] U.S. Cl. .... D9/447

[58] Field of Search ..... D9/438, 454, 447, 443, D9/435, 428, 429; 220/90.4, 90.6, 271, 265, 266, 268, 269, 270; 229/1.5 B, 7 R

[56] References Cited

U.S. PATENT DOCUMENTS

D. 209,483	12/1967	Frank	.....	D9/454
D. 240,601	7/1976	Newman	.....	D9/447
D. 267,633	1/1983	Christian	.....	D9/443 X
D. 274,983	8/1984	Dart et al.	.....	D9/447
4,113,135	9/1978	Yamazaki	.....	220/268
4,187,954	2/1980	Striggow	.....	229/7 R X
4,202,459	5/1980	De Parales et al.	.....	D9/438 X
4,215,793	8/1980	Packard	.....	220/270
4,243,156	1/1981	Lobbestael	.....	220/265 X
4,350,260	9/1982	Prueher	.....	220/268 X
4,360,121	11/1982	Helms	.....	220/270

Primary Examiner—Bernard Ansher  
Assistant Examiner—Linda Titolo  
Attorney, Agent, or Firm—Miller, Morriss & Pappas

[57] CLAIM

The ornamental design for a lid for a container, as shown and described.

DESCRIPTION

FIG. 1 is a top plan view of a lid for a container, showing our new design;  
 FIG. 2 is a side elevational view thereof;  
 FIG. 3 is a bottom plan view thereof;  
 FIG. 4 is a cross-sectional view thereof taken on line 4—4 of FIG. 1;  
 FIG. 5 is a fragmentary cross-sectional view thereof, taken on line 5—5 of FIG. 1, the broken lines indicating liquid and a fragmentary cup wall are shown for illustrative purposes only;  
 FIG. 6 is a fragmentary top plan view of a second embodiment of that shown in FIG. 1;  
 FIG. 7 is a cross-sectional view thereof taken on line 7—7 of FIG. 6;  
 FIG. 8 is a top plan view of a third embodiment of that shown in FIG. 1;  
 FIG. 9 is a side elevational view thereof;  
 FIG. 10 is a bottom plan view thereof;  
 FIG. 11 is a cross-sectional view thereof taken on line 11—11 of FIG. 8;  
 FIG. 12 is a fragmentary top plan view of a fourth embodiment of that shown in FIG. 1;  
 FIG. 13 is a cross-sectional view thereof taken on line 13—13 of FIG. 12;  
 FIG. 14 is a top perspective view of the embodiment shown in FIG. 1, the broken lines indicating a cup are shown for illustrative purposes only;  
 FIG. 15 is a top perspective view of the second embodiment of that shown in FIG. 1;  
 FIG. 16 is a top perspective view of the third embodiment of that shown in FIG. 1; and  
 FIG. 17 is a top perspective view of the fourth embodiment of that shown in FIG. 1.

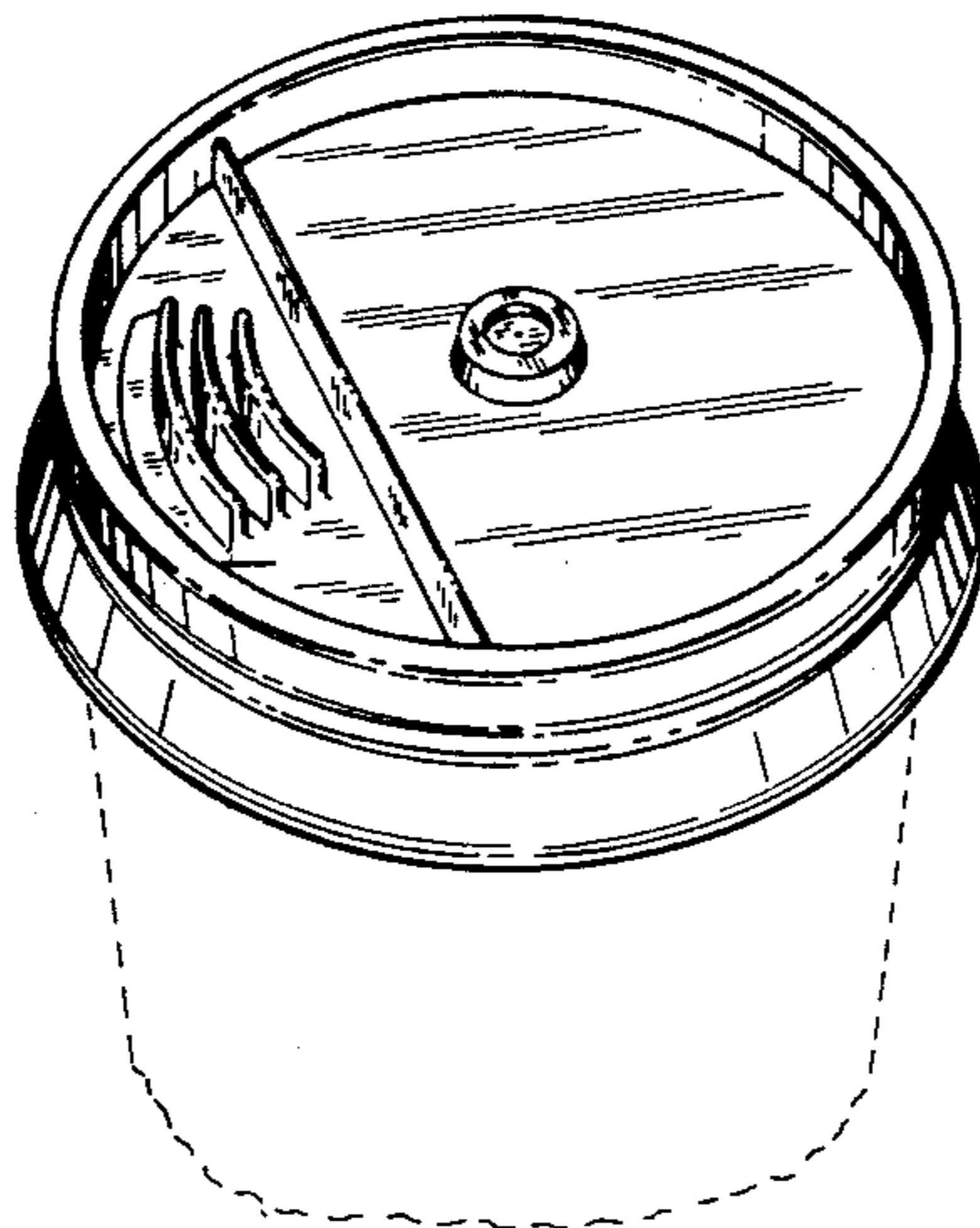

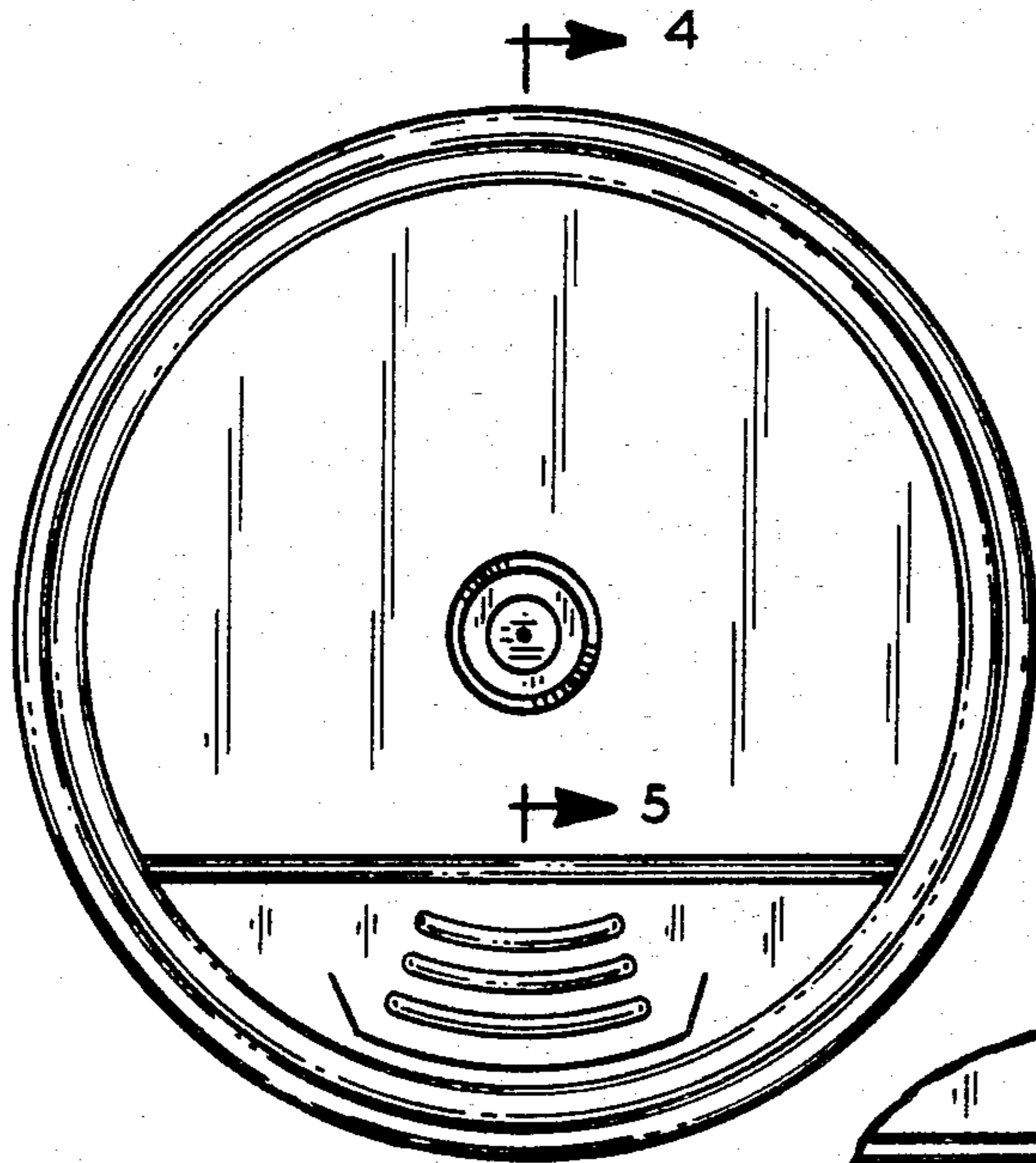

FIG. 1

FIG. 2

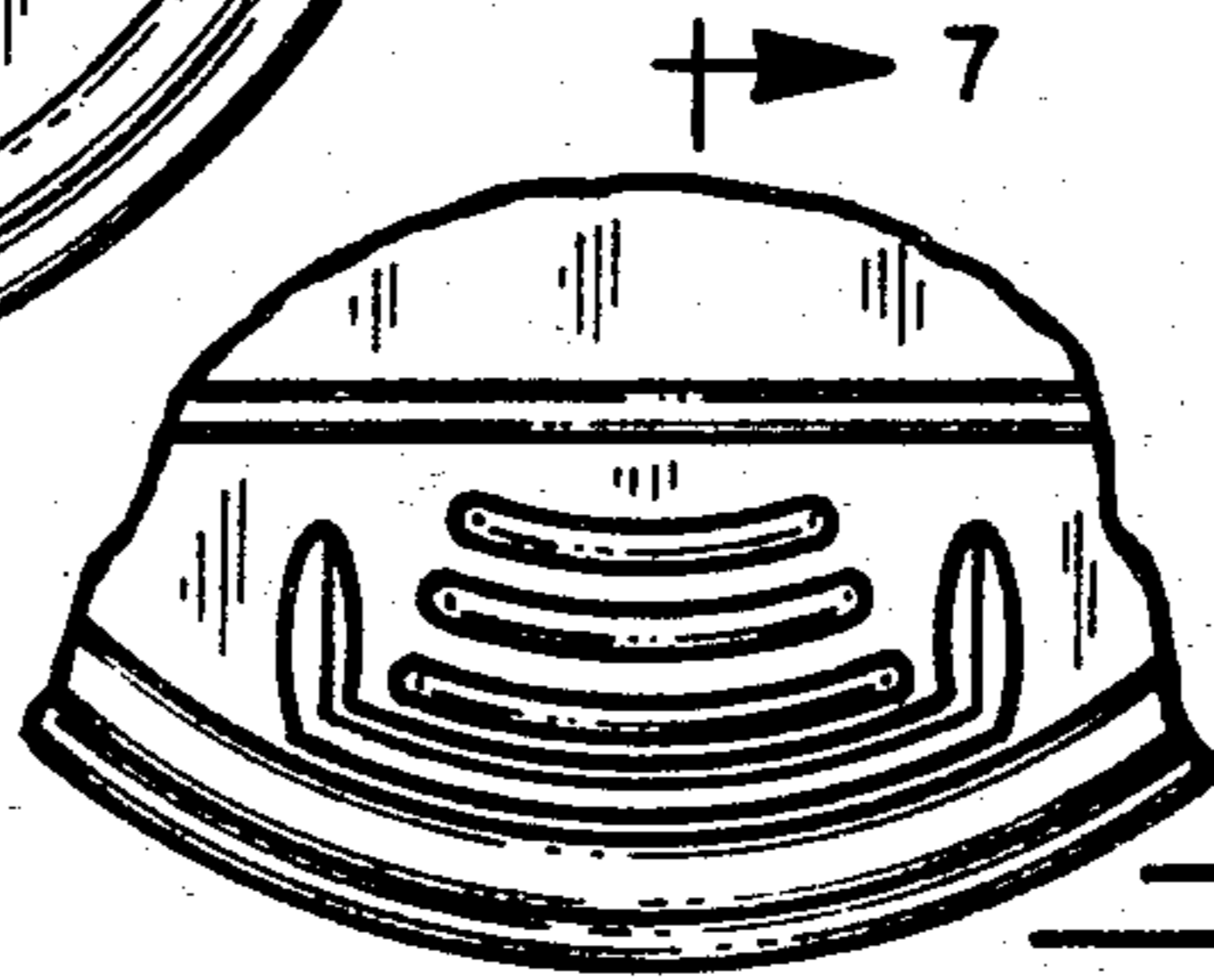

FIG. 6

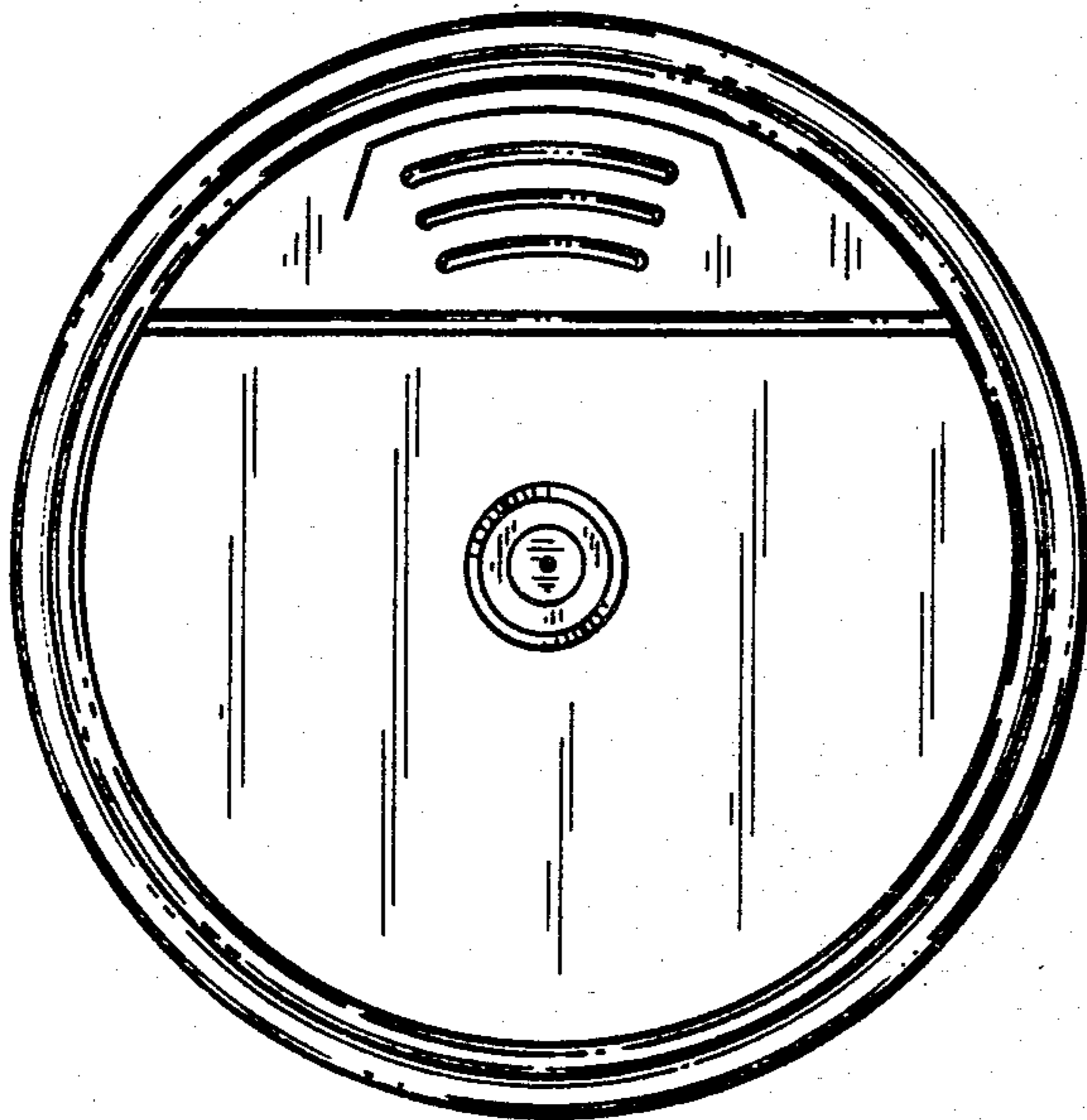

FIG. 3

FIG. 5

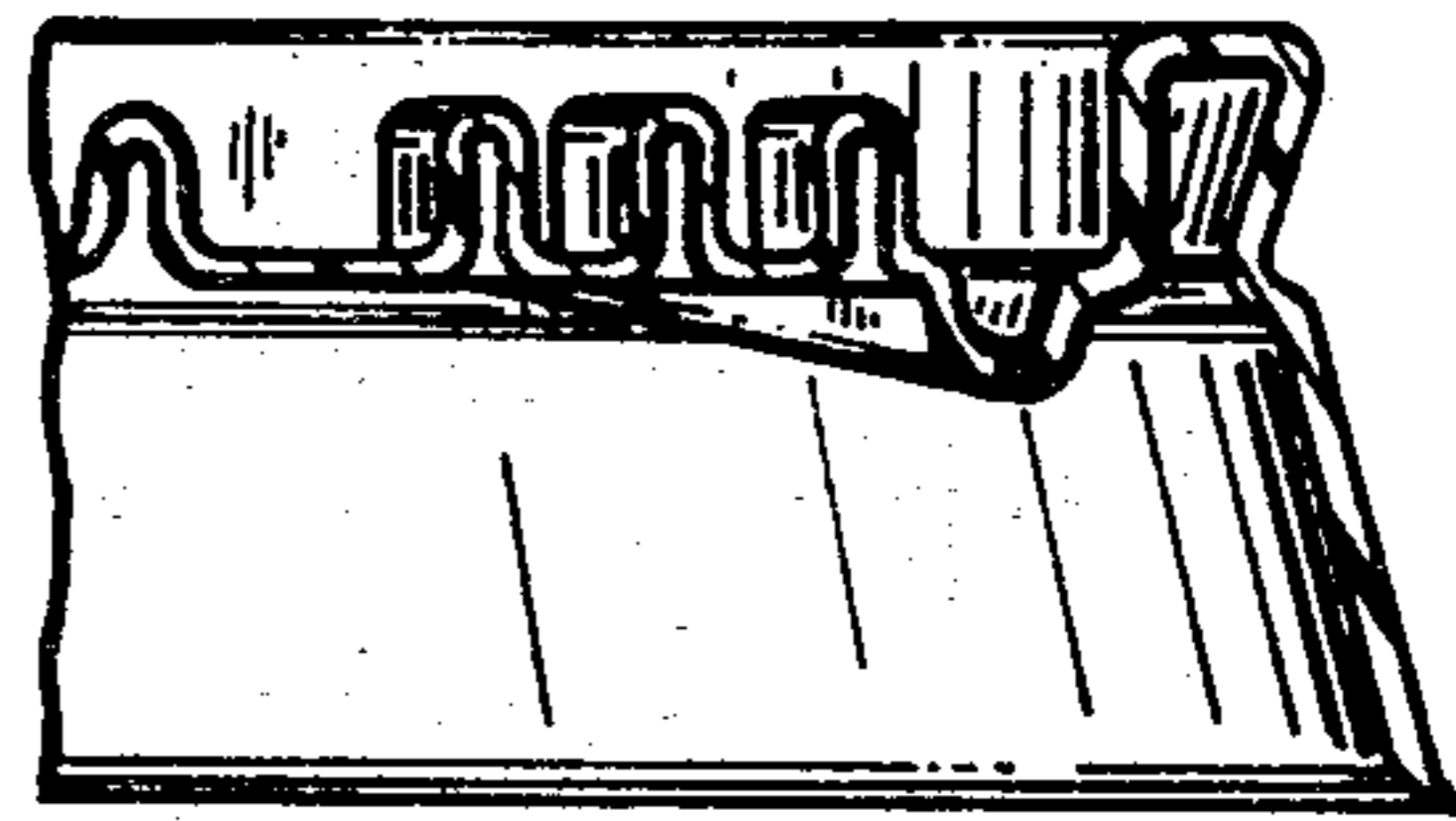
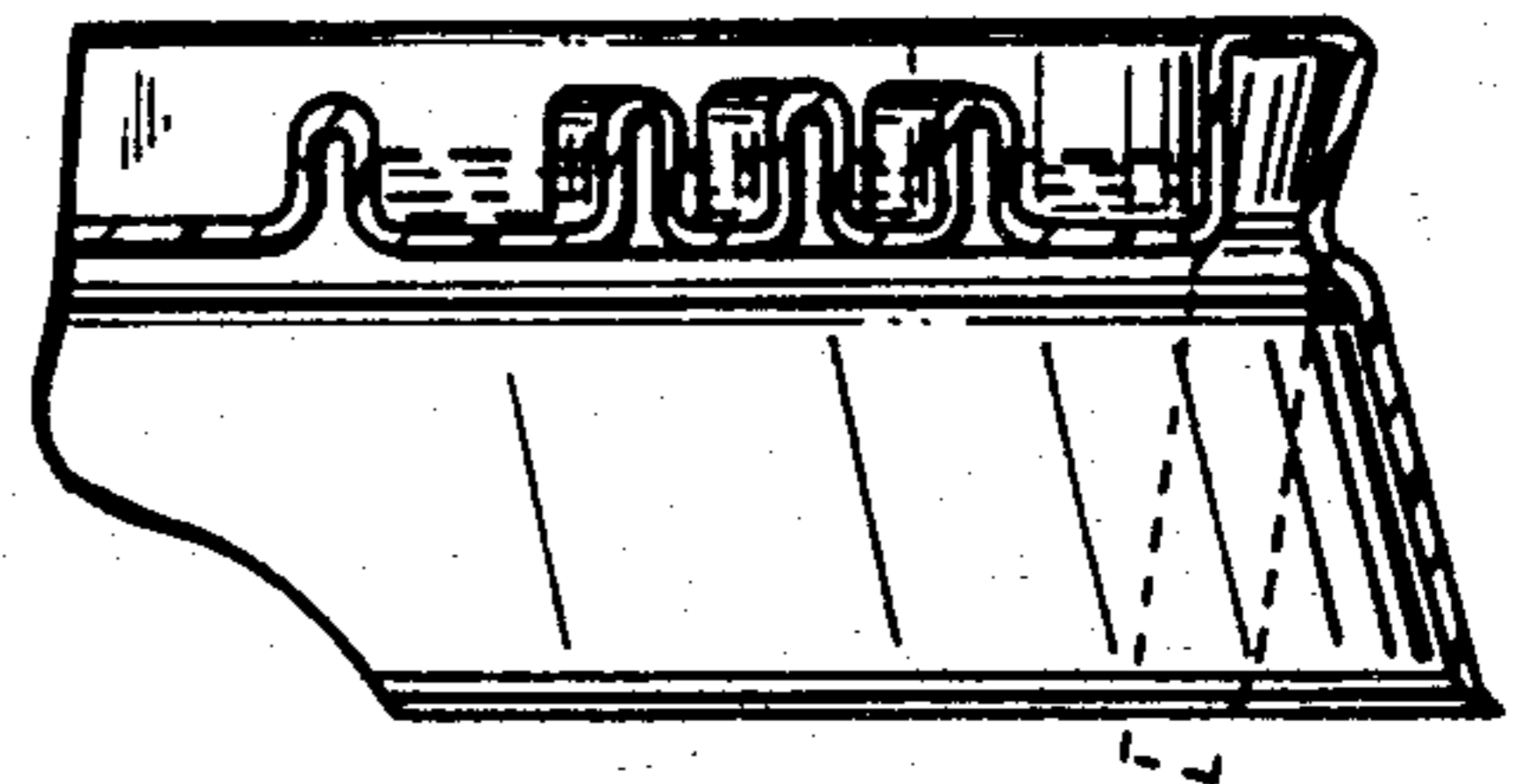

FIG. 7

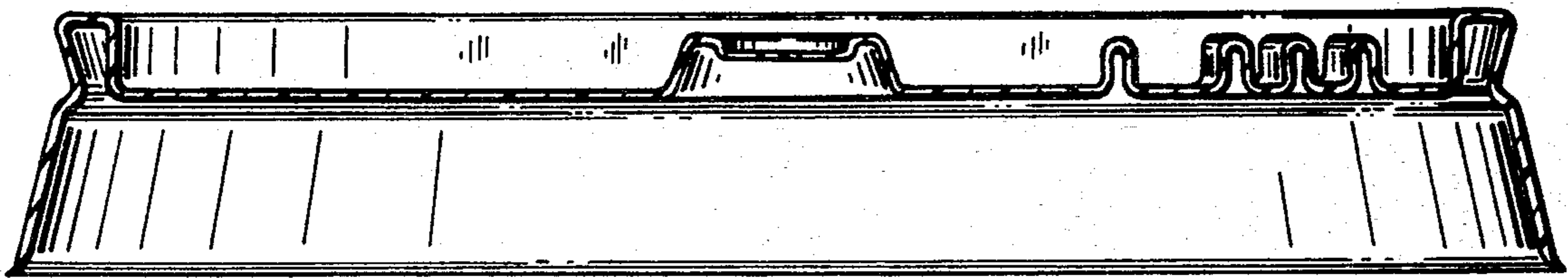

FIG. 4



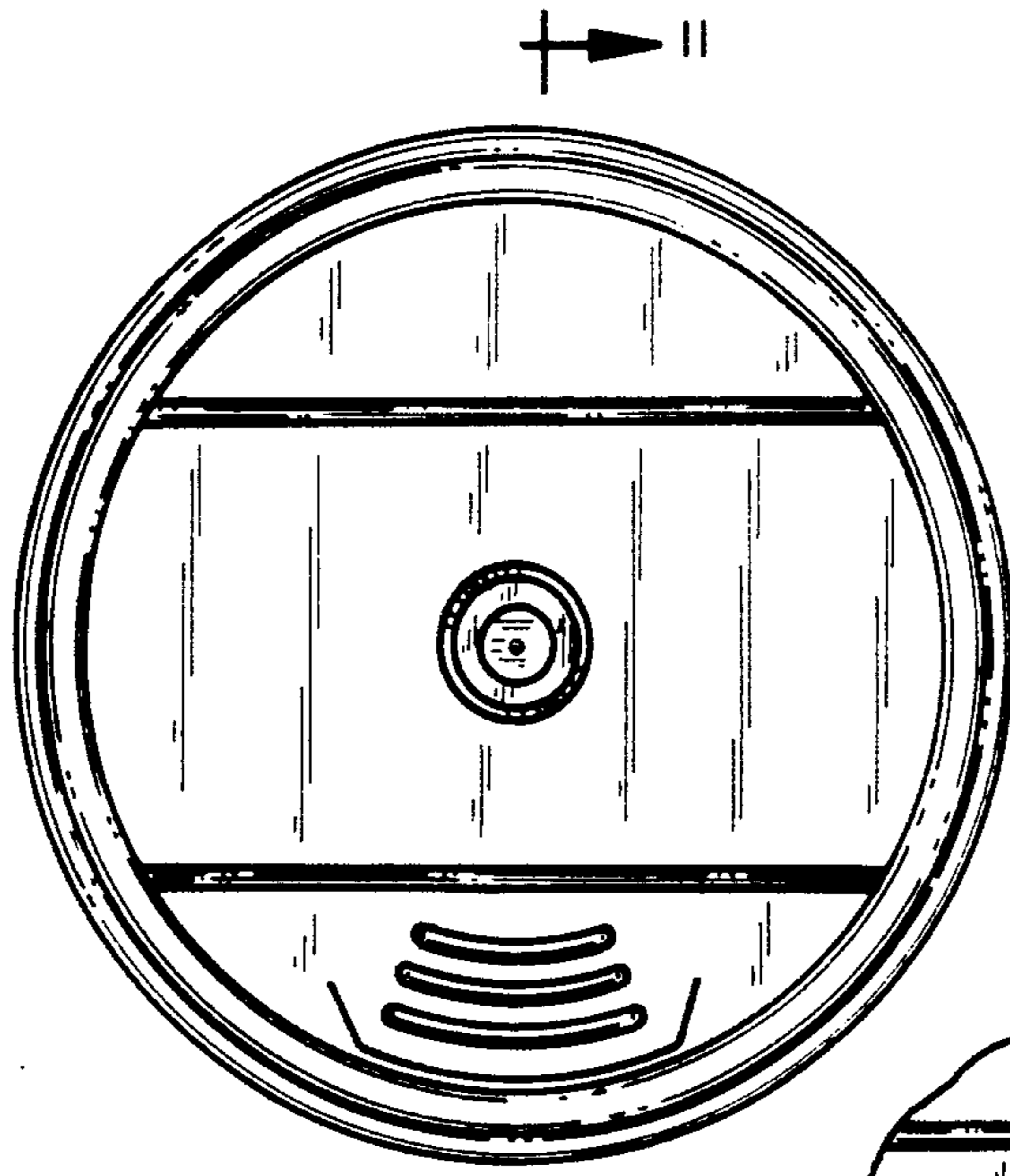

FIG. 8

FIG. 9

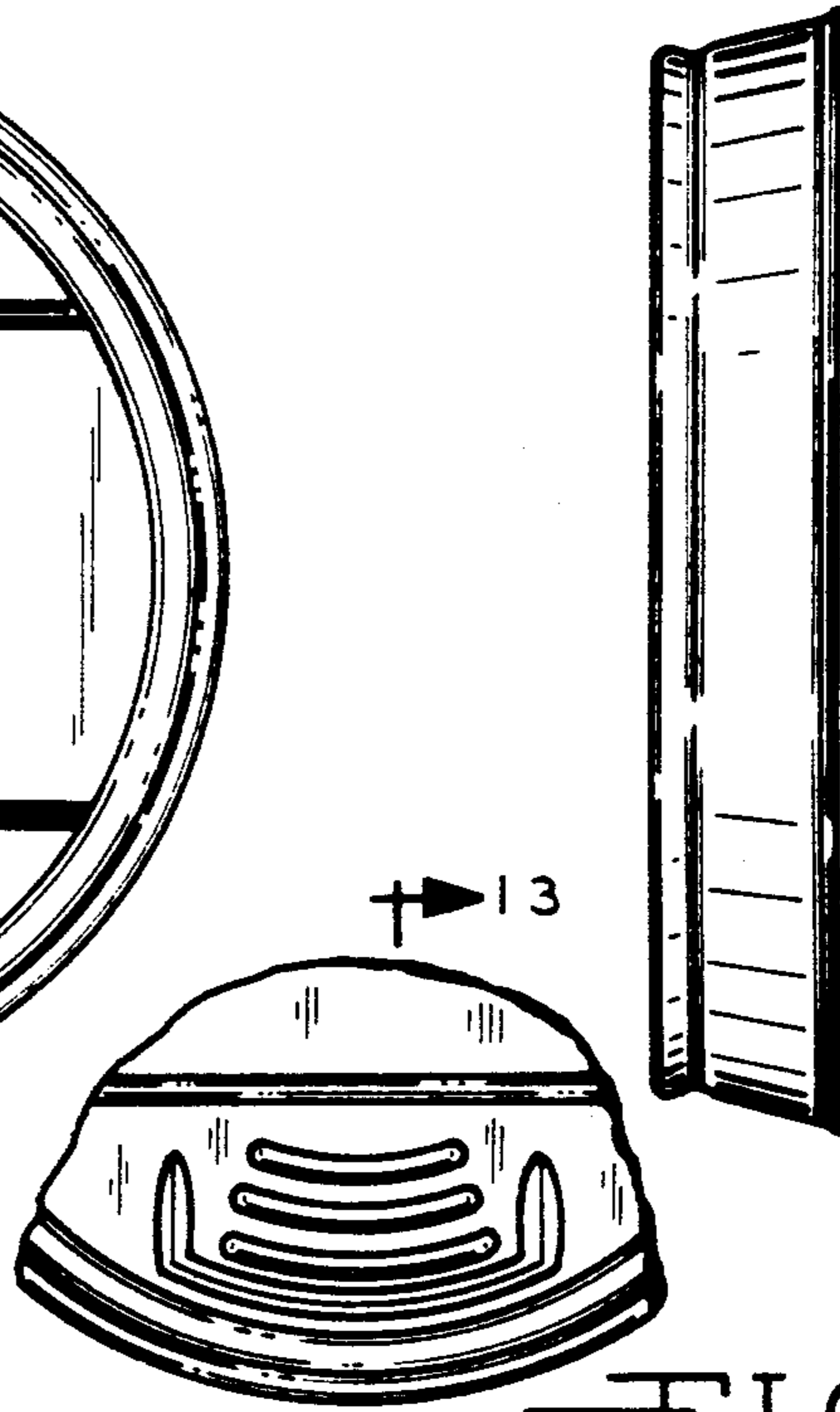

FIG. 12

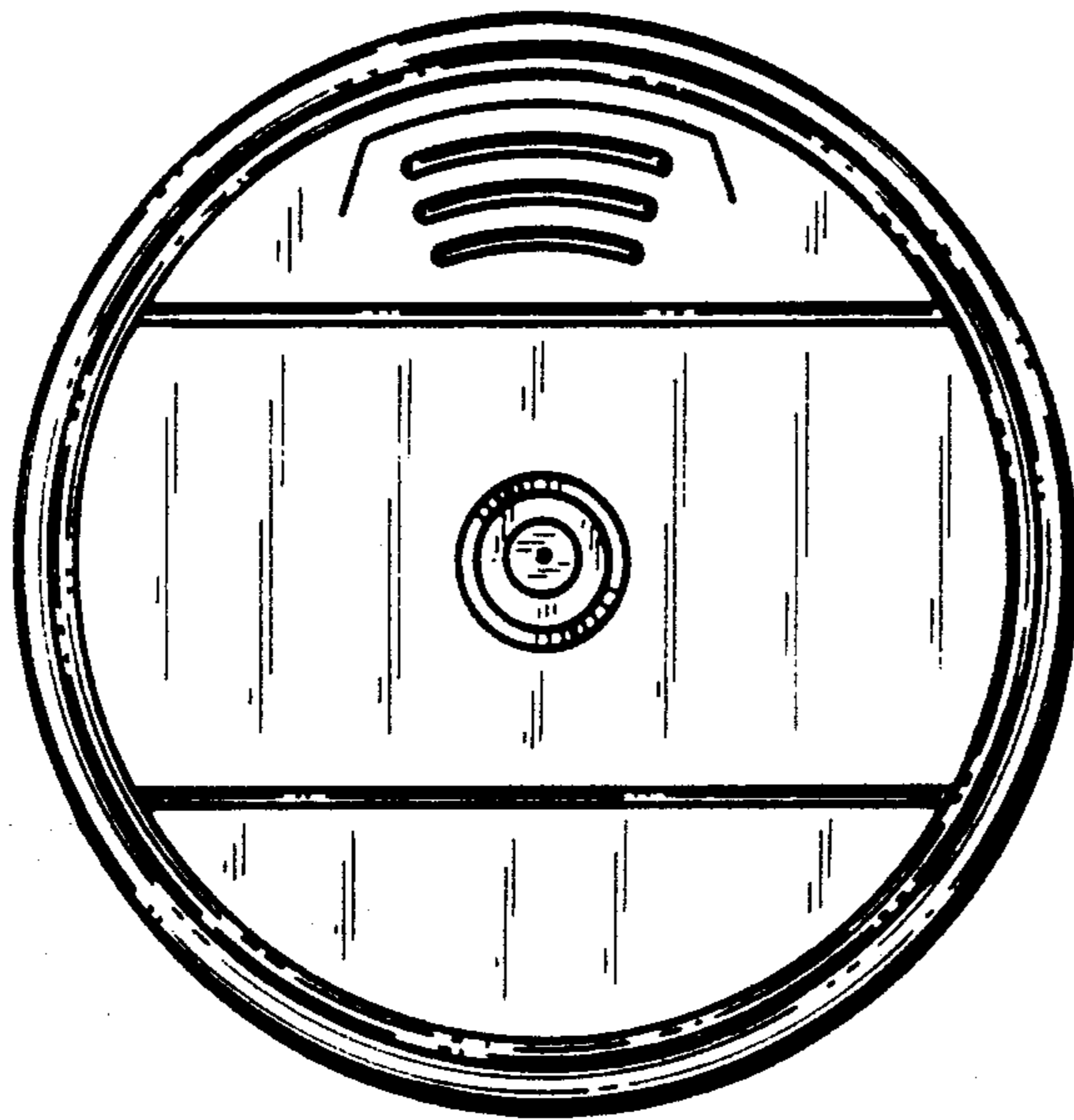

FIG. 10

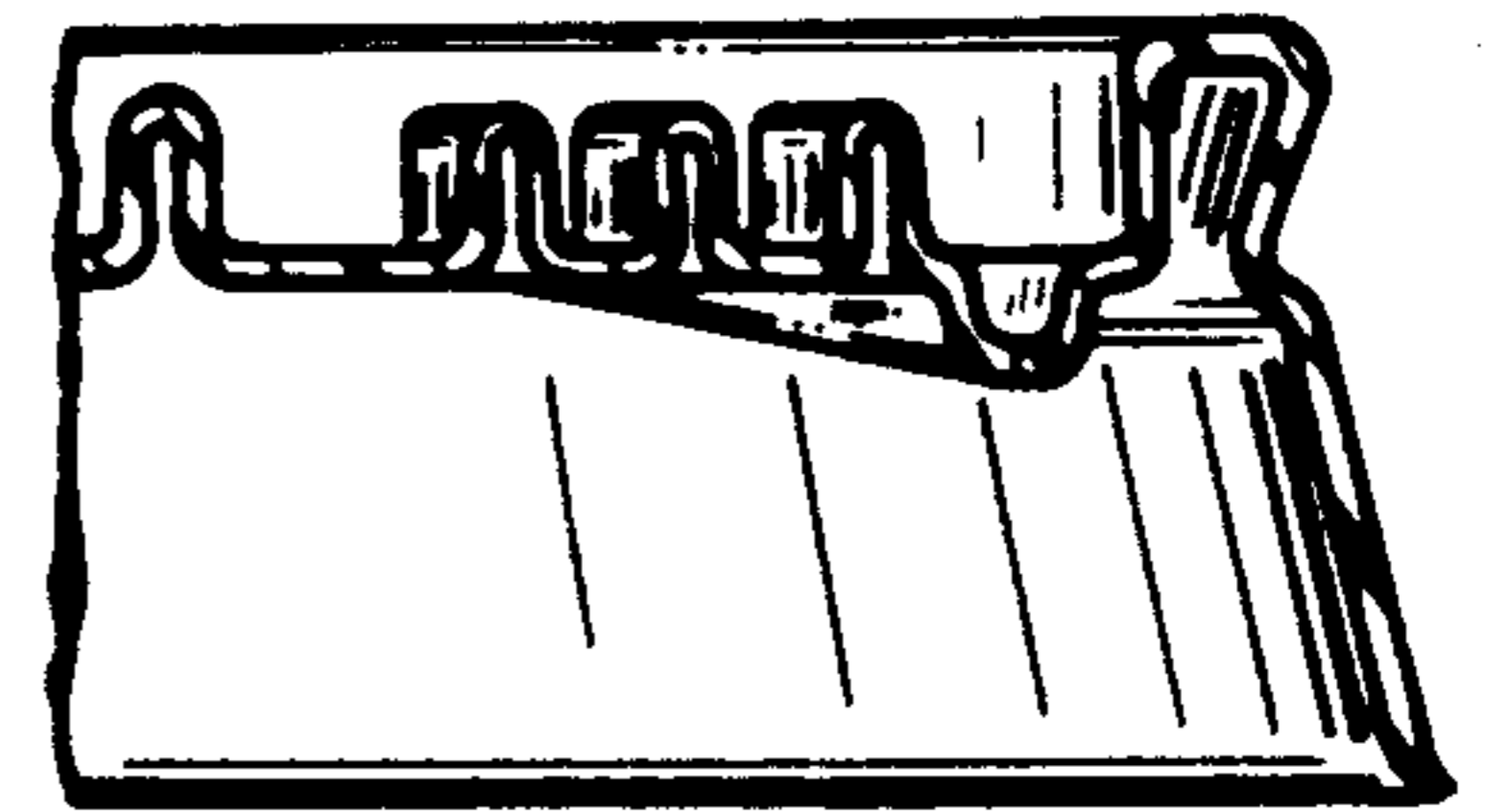

FIG. 13

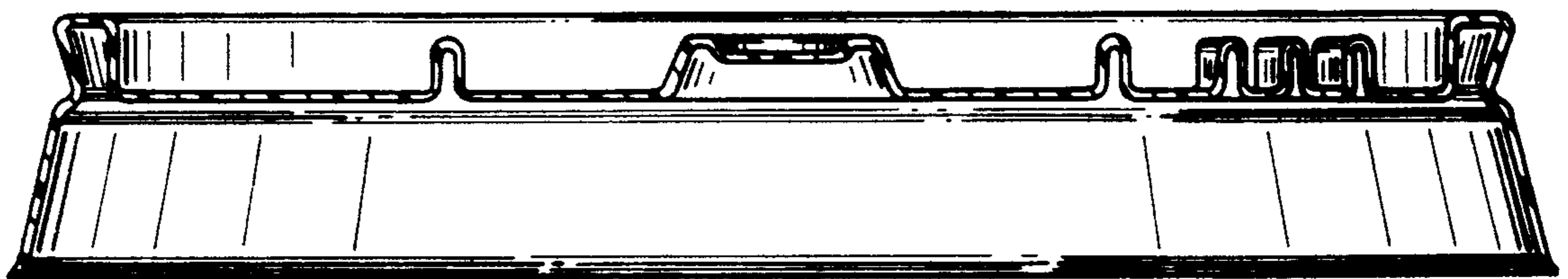
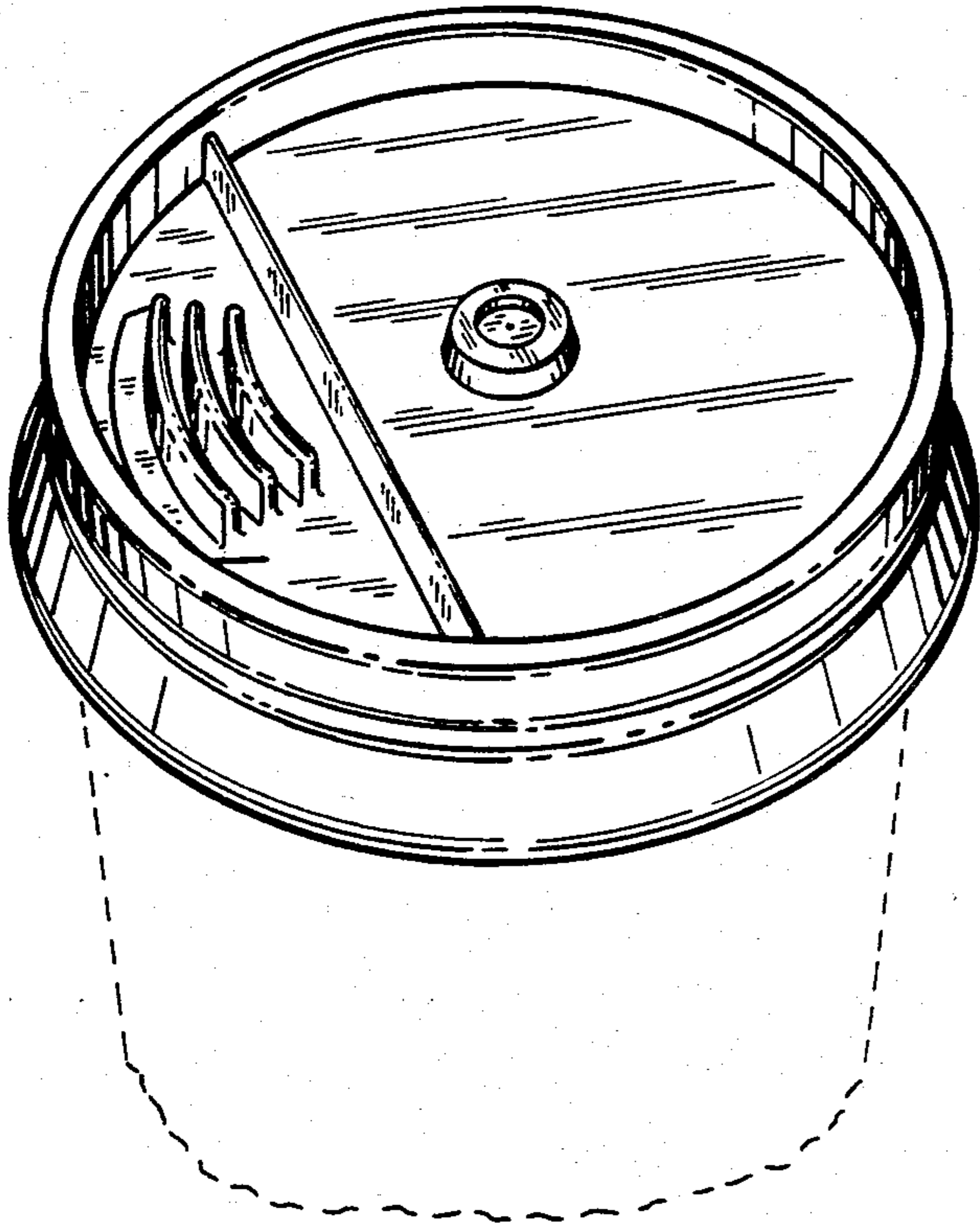
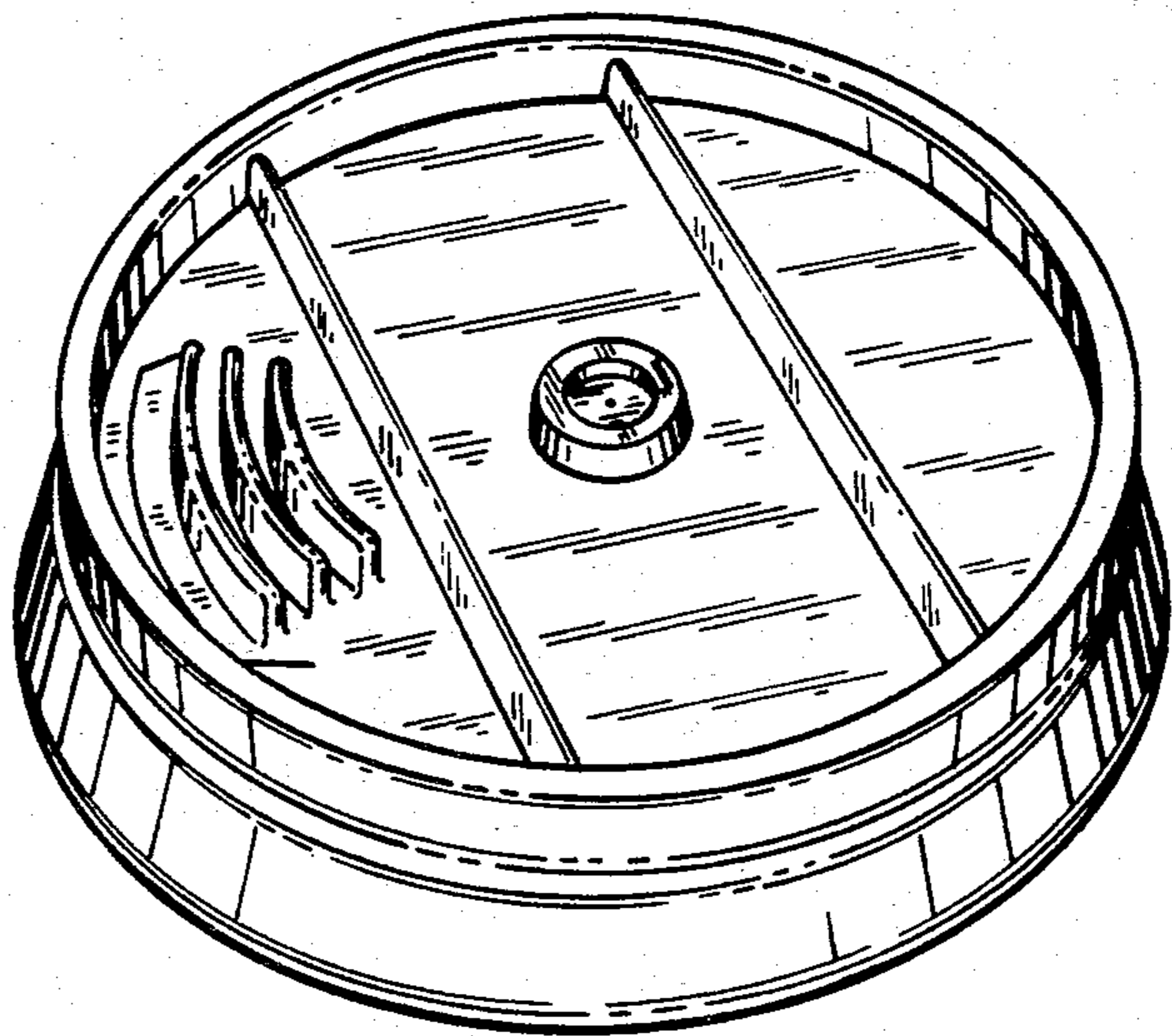

FIG. 11



—FIG. 14



—FIG. 16

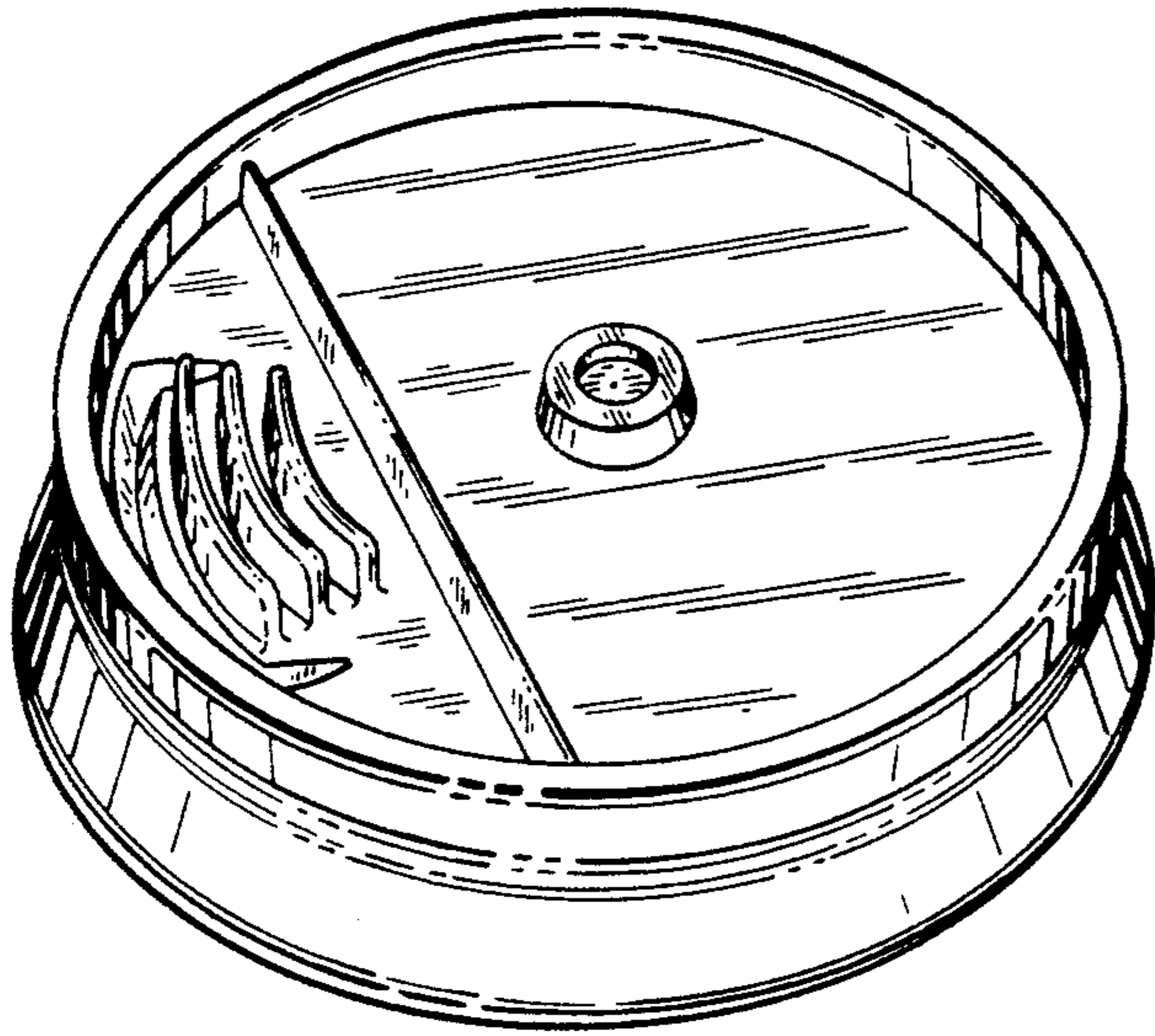

—FIG. 15

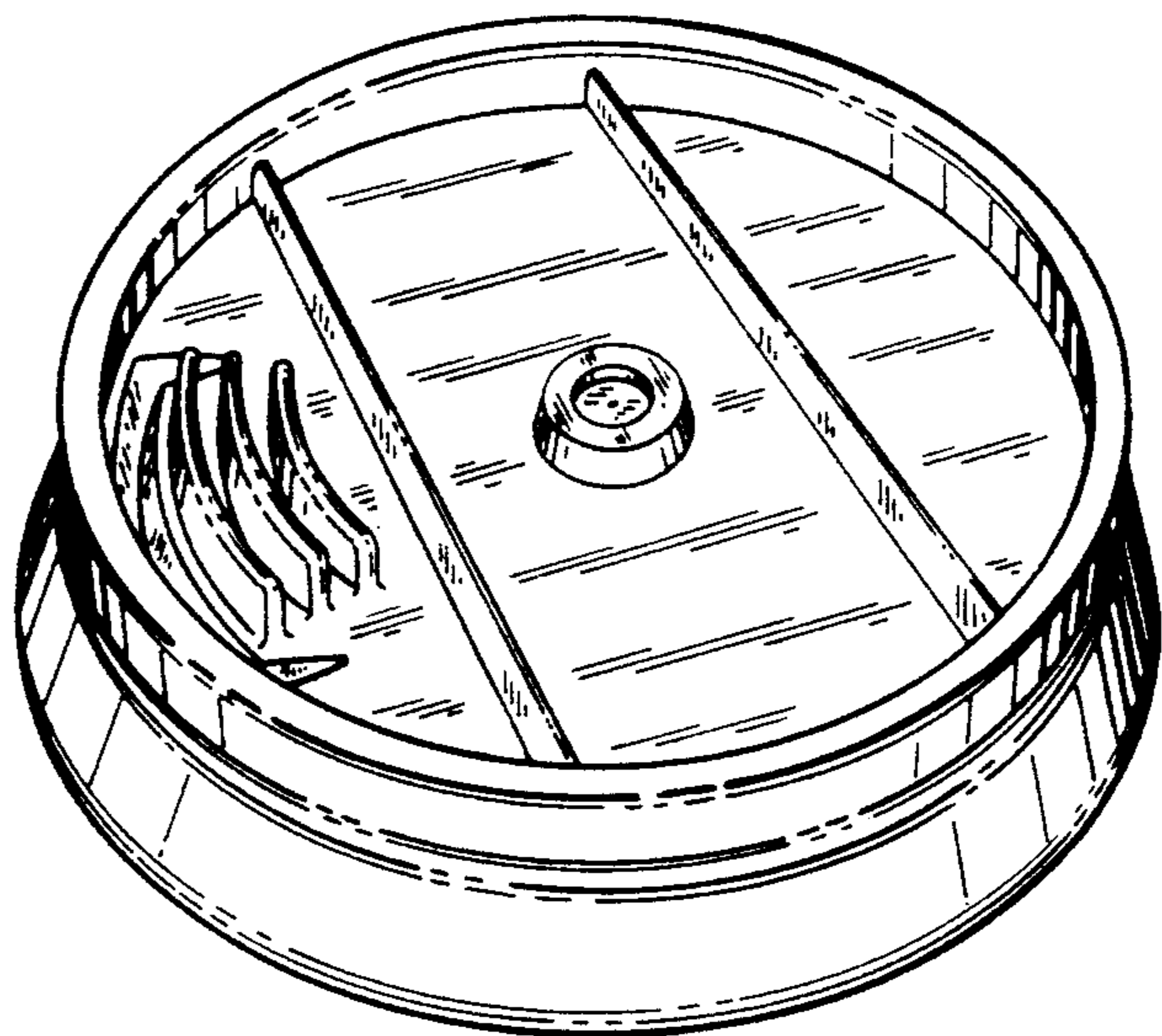

—FIG. 17