

[54] BOWL

[75] Inventor: Kenneth H. Grange, London, England

[73] Assignee: Thorn Emi Domestic Appliances Limited, London, England

[**] Term: 14 Years

[21] Appl. No.: 561,943

[22] Filed: Dec. 15, 1983

[30] Foreign Application Priority Data

Aug. 20, 1983 [GB] United Kingdom 83-1014748
[52] U.S. Cl. D7/412; D7/23
[58] Field of Search D7/412, 23, 76, 354, D7/409; 220/70

[56] References Cited

U.S. PATENT DOCUMENTS

D. 175,385 8/1955 Bliss D7/23
D. 184,761 3/1959 Ostrowsky D7/23
D. 257,931 1/1981 Conti D7/23
D. 276,114 10/1984 Conti et al. D7/354 X
2,317,067 4/1943 Knaust D7/76 X

2,420,940 5/1947 Eldridge D7/409 X
2,711,840 6/1955 Gits et al. D7/76 X
3,529,531 9/1970 Swett D7/76 X
4,303,170 12/1981 Panicci 220/70

Primary Examiner—Bernard Ansher
Assistant Examiner—Linda Titolo
Attorney, Agent, or Firm—Fleit, Jacobson, Cohn & Price

[57] CLAIM

The ornamental design for a bowl, substantially as shown.

DESCRIPTION

FIG. 1 is a top front right side perspective view of a bowl showing my new design;
FIG. 2 is a bottom plan view thereof;
FIG. 3 is a cross-sectional view thereof, taken on line 3—3 of FIG. 2;
FIG. 4 is a cross-sectional view thereof, taken on line 3—3 of FIG. 2;
FIG. 5 is a top plan view thereof;
FIG. 6 is a right side elevational view thereof;
FIG. 7 is a front elevational view thereof;
FIG. 8 is a left side elevational view thereof; and
FIG. 9 is a rear elevational view thereof.

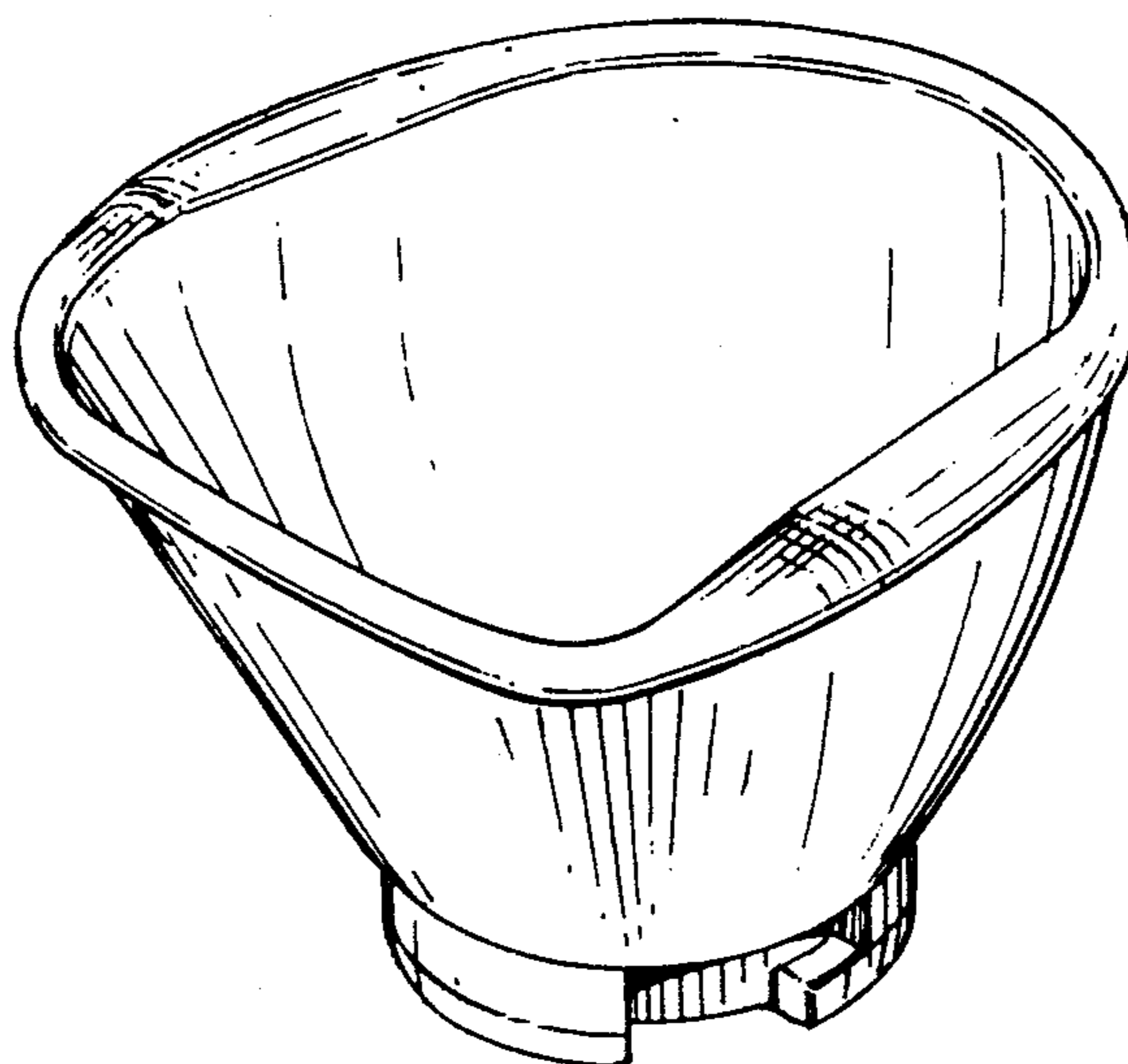

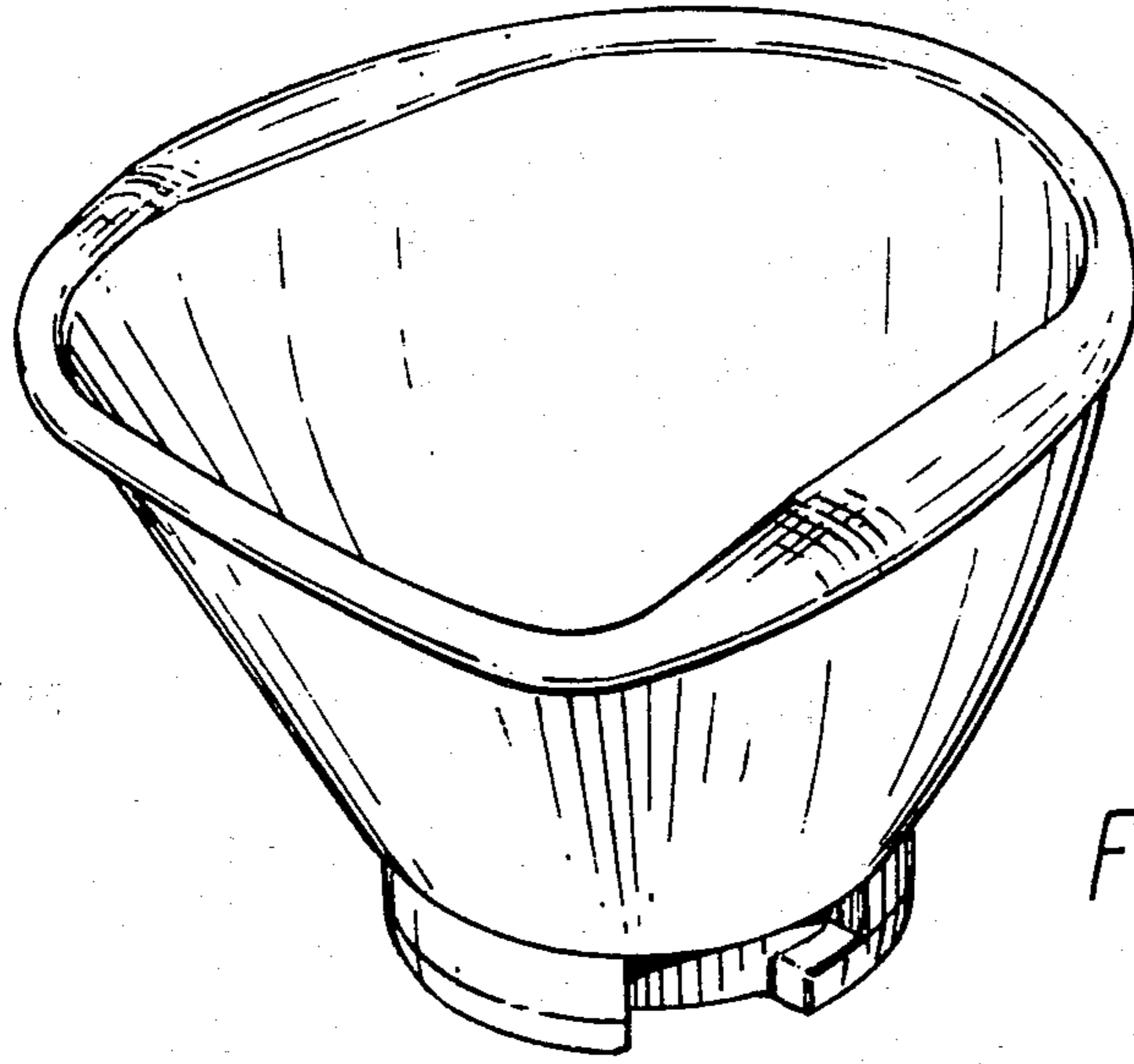

FIG. 1

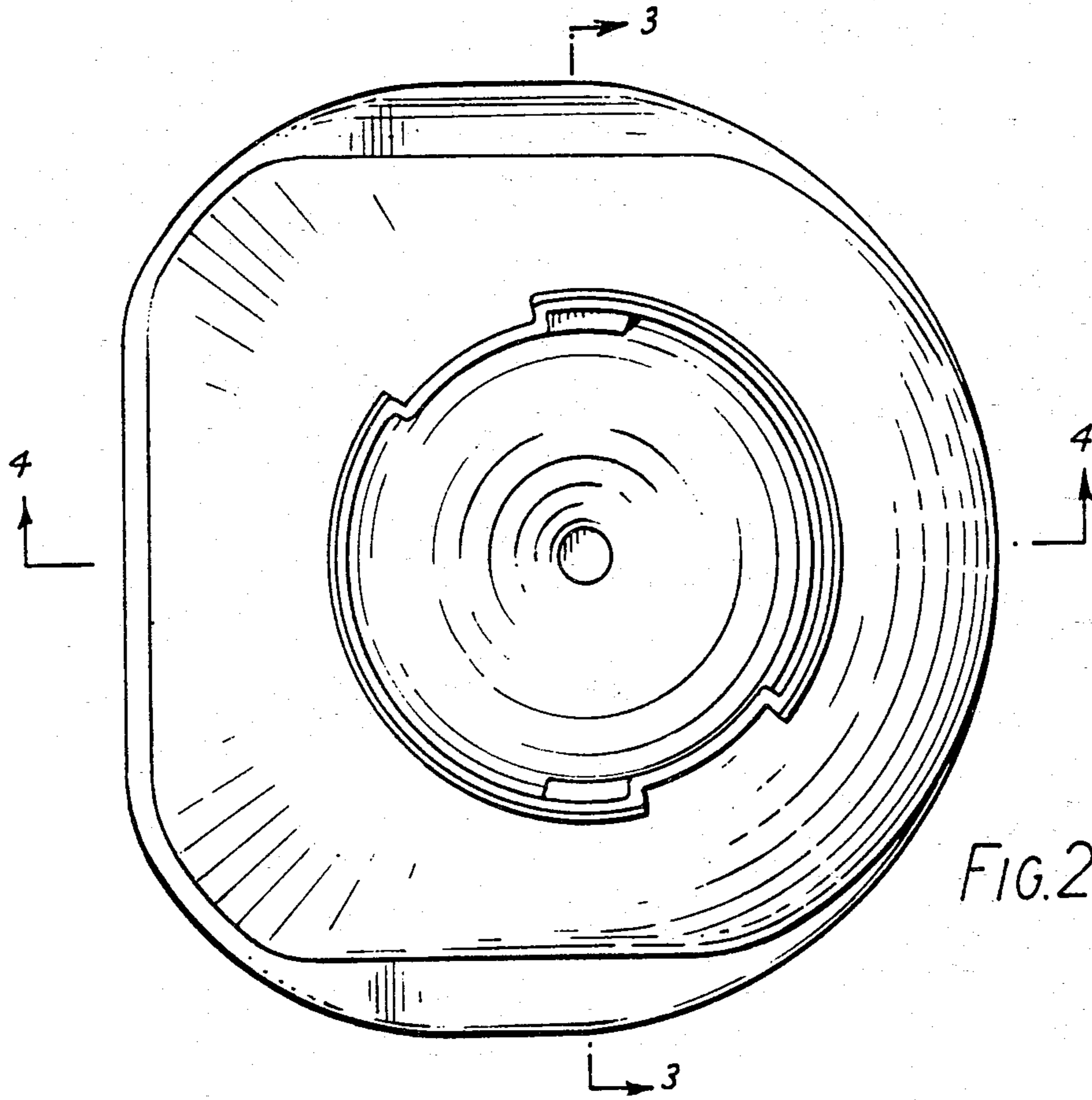

FIG. 2

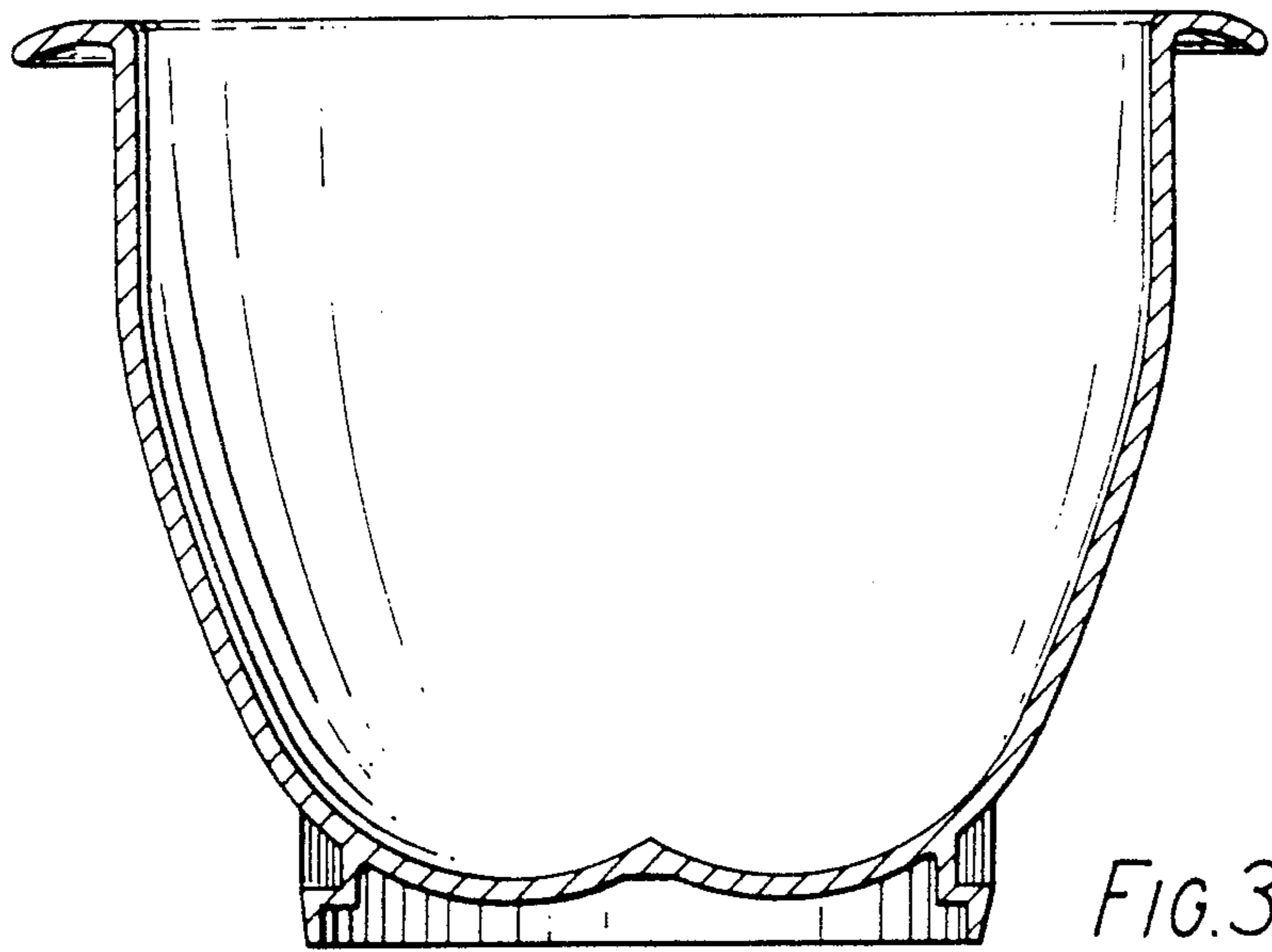

FIG. 3

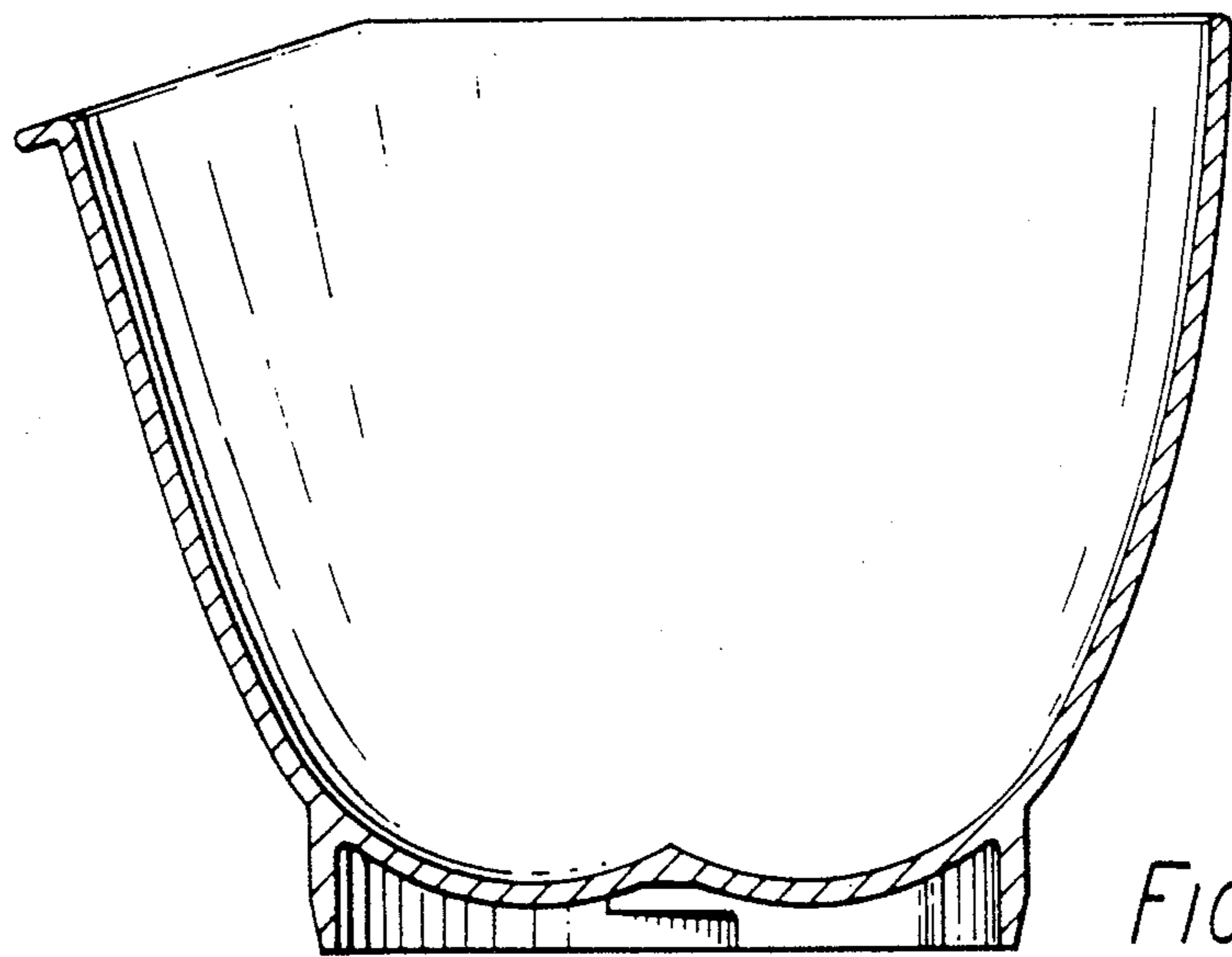

FIG. 4

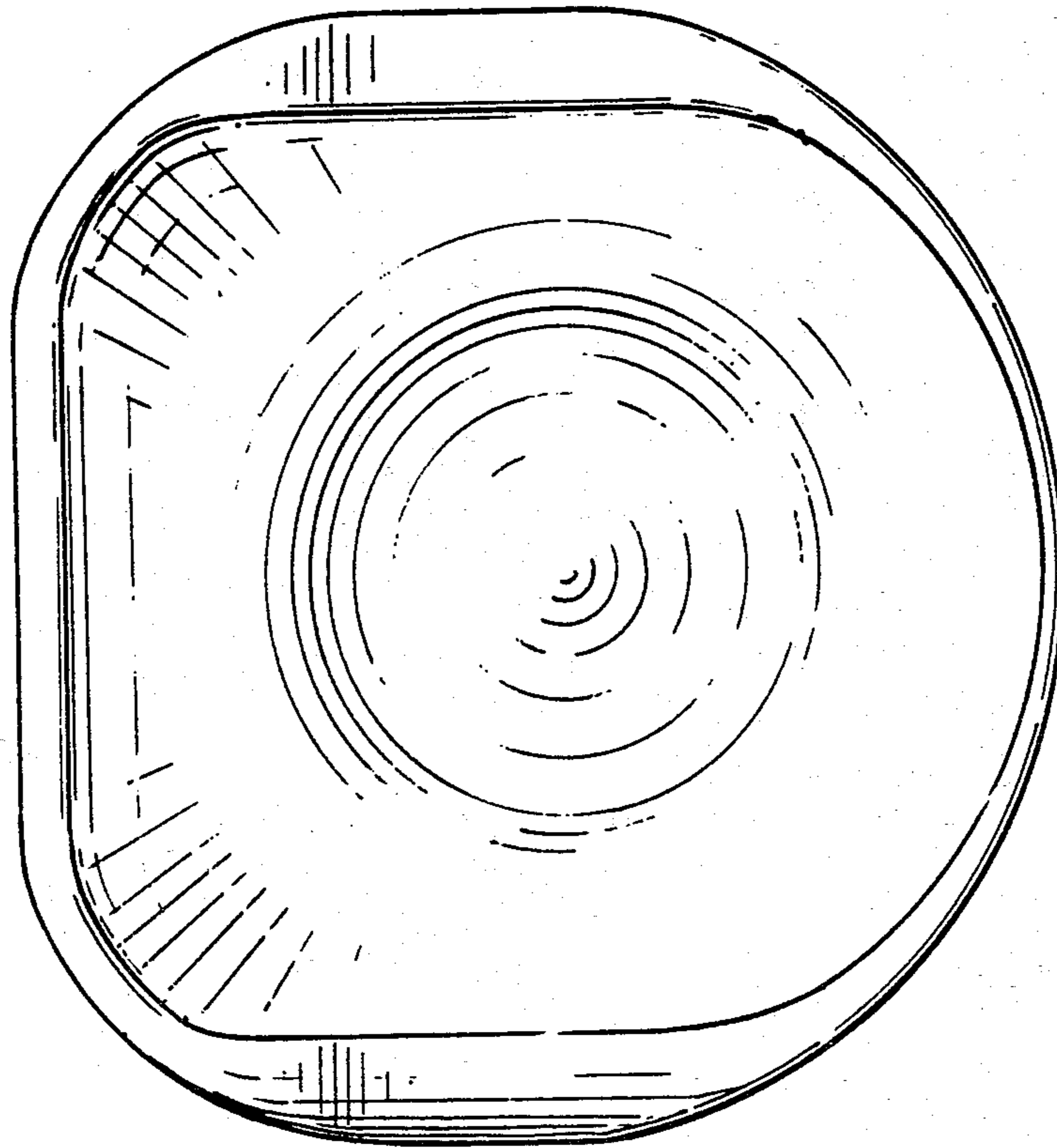

FIG. 5

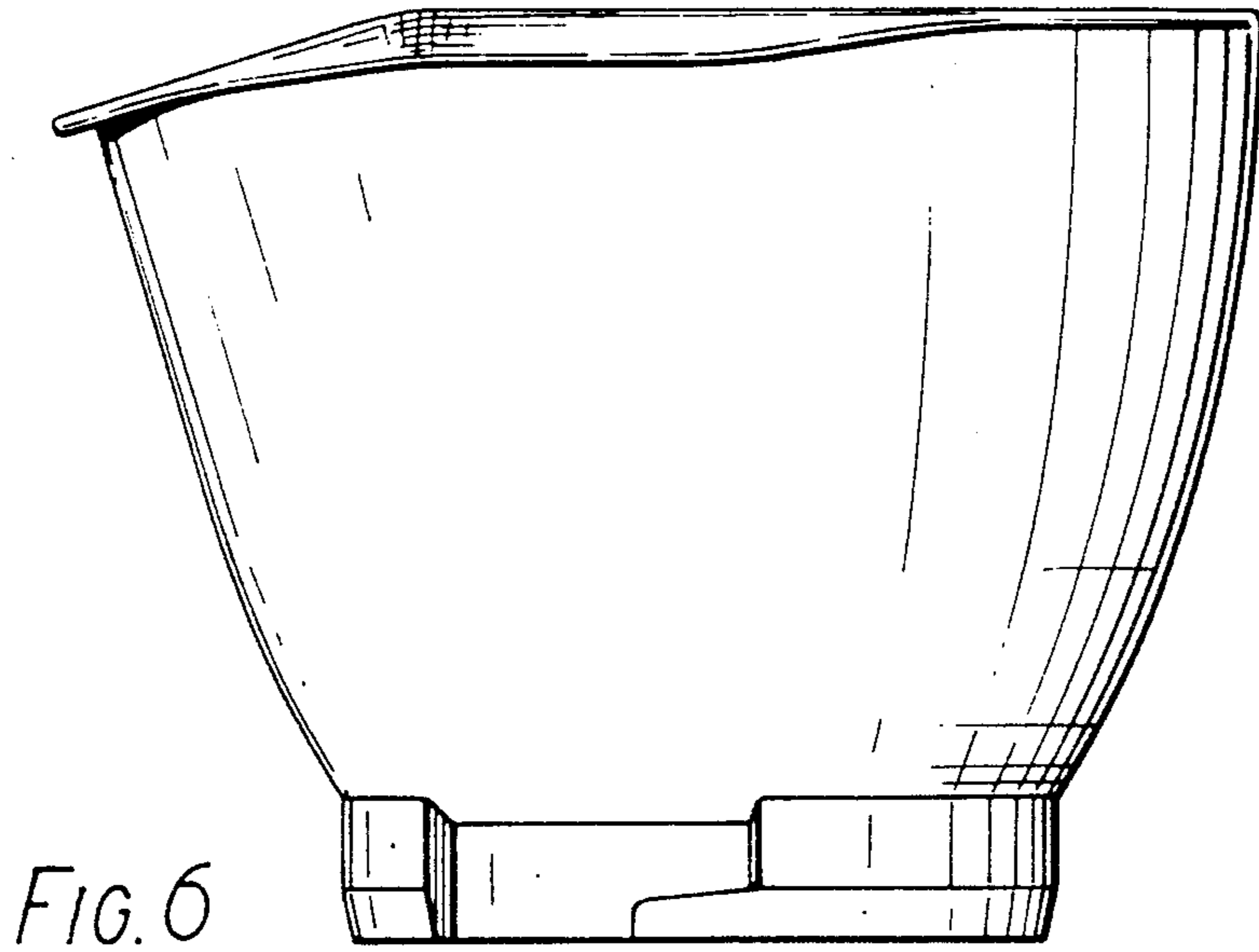

FIG. 6

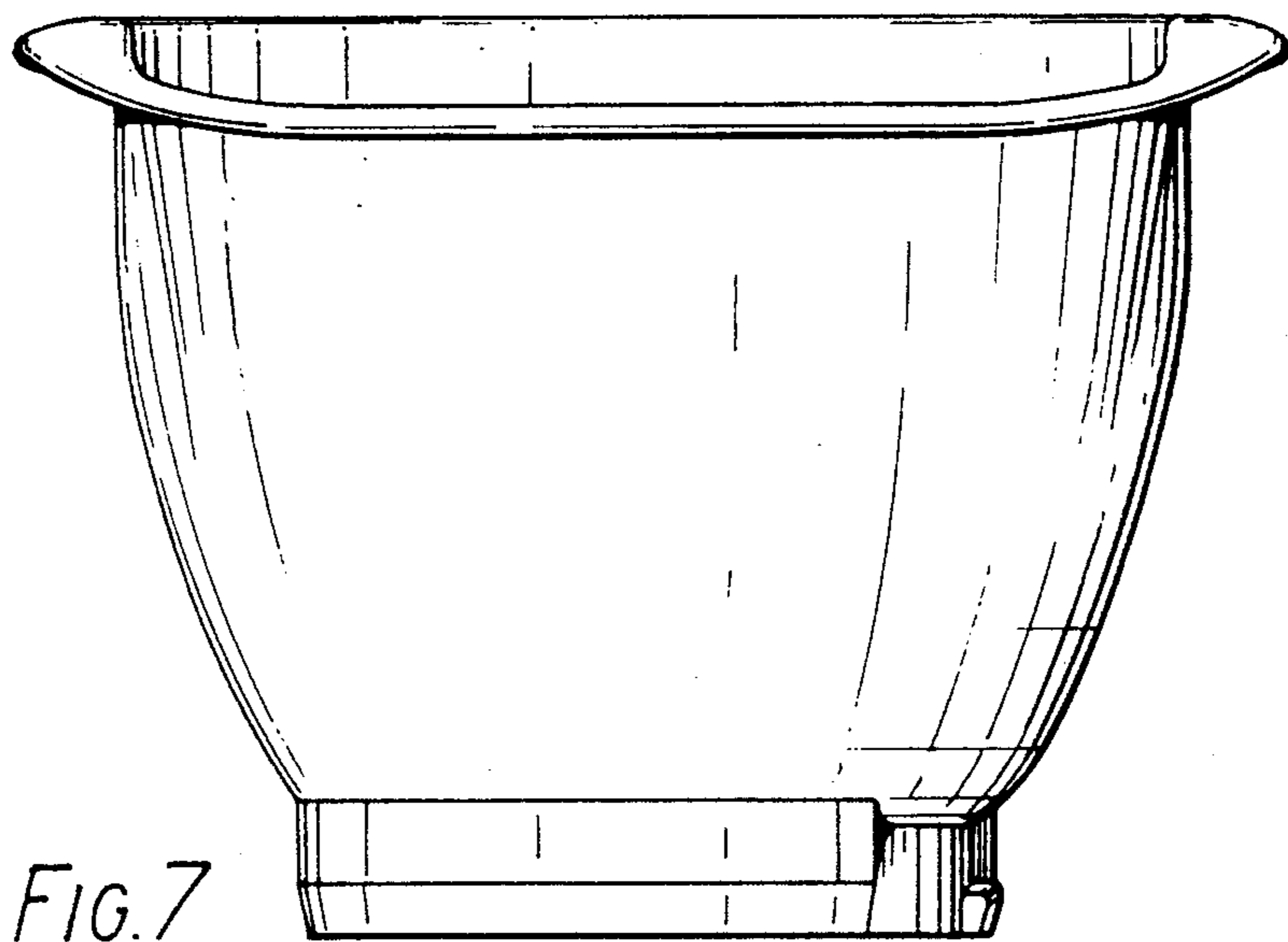

FIG. 7

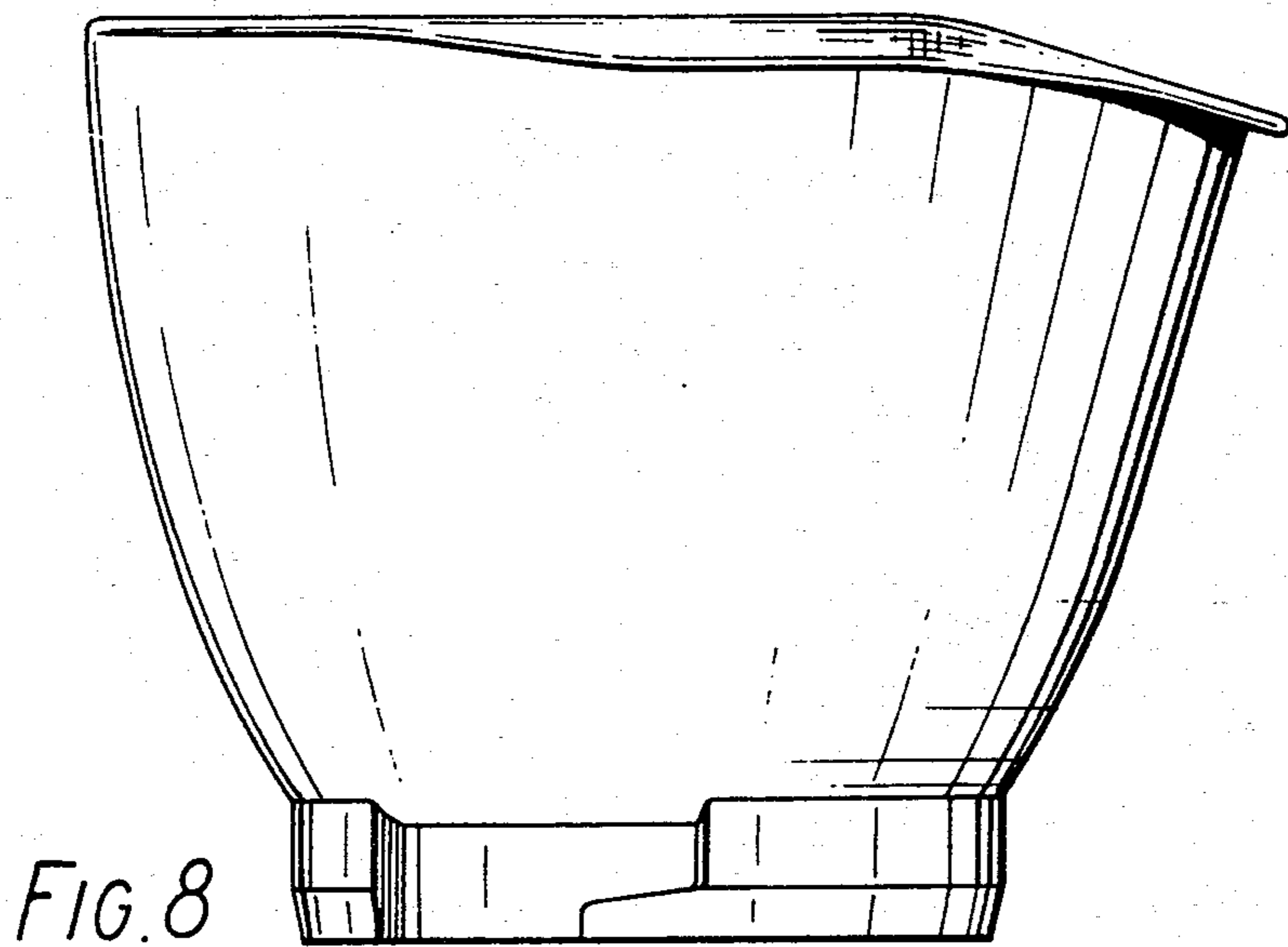

FIG. 8

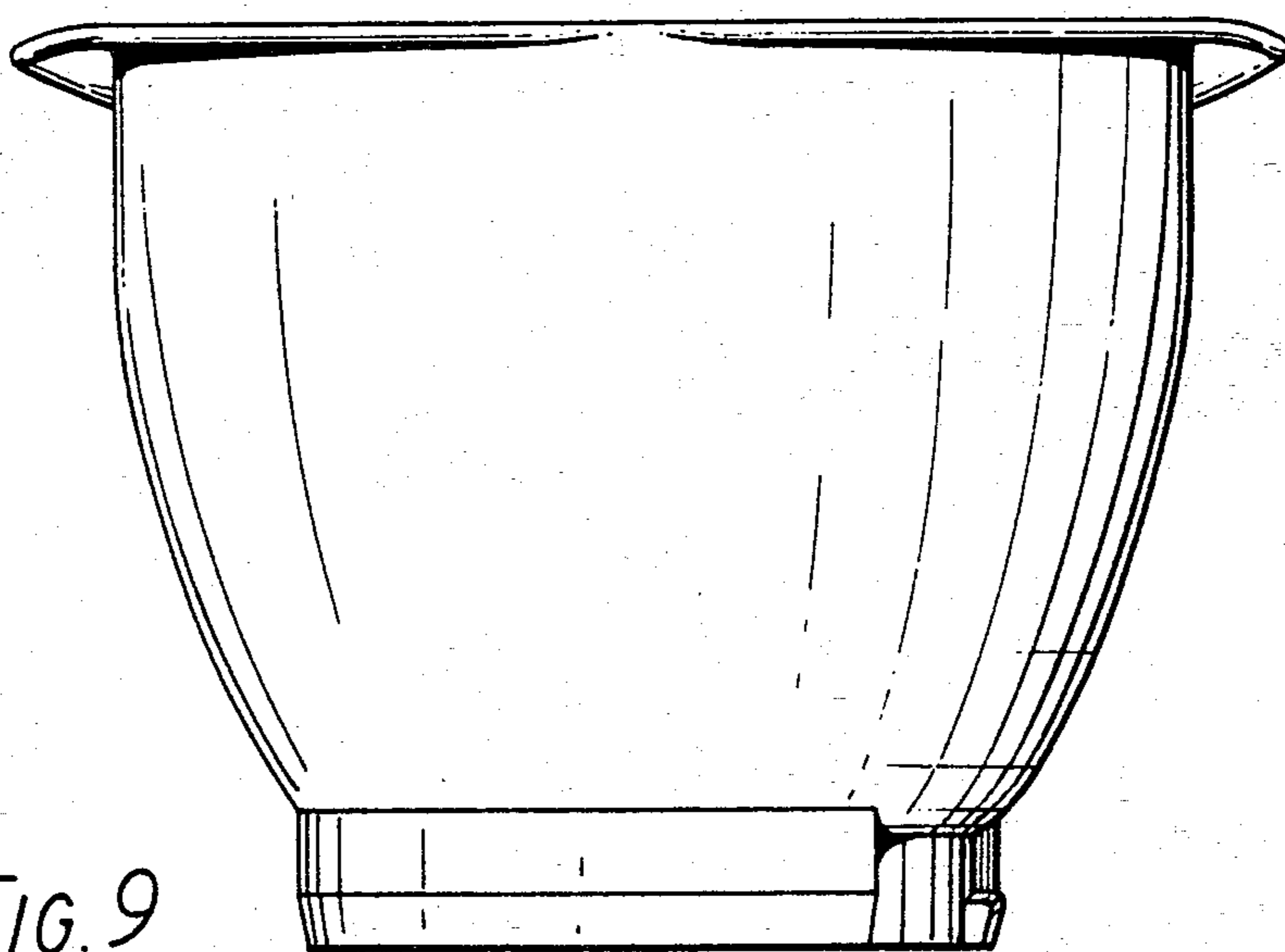

FIG. 9