

[54] **DOSAGE DEVICE FOR SYRINGES**

[76] **Inventor: James B. Olson, Torsdagsvägen 40,  
S-863 00 Sundsbruk, Sweden**

[\*\*] **Term: 14 Years**

[21] **Appl. No.: 509,298**

[22] **Filed: Jun. 30, 1983**

[30] **Foreign Application Priority Data**

Jan. 10, 1983 [SE] Sweden ..... 83-0053

[52] **U.S. Cl. .... D24/31**

[58] **Field of Search ..... D24/29, 31, 32, 8, 14,  
D24/25; D9/341; D8/71; D6/474; 435/291,  
299, 300, 301; 422/58, 102; 356/246; 211/74,  
60.1, 71, 13, 69.1**

[56] **References Cited**

**U.S. PATENT DOCUMENTS**

D. 157,024 1/1950 Bacco et al. .... D6/474 X  
1,978,290 10/1934 Arthur ..... 211/13  
3,731,819 5/1973 Sandhage ..... 211/74

*Primary Examiner*—A. Hugo Word  
*Assistant Examiner*—Stella Reid  
*Attorney, Agent, or Firm*—Lerner, David, Littenberg,  
Krumholz & Mentlik

[57] **CLAIM**

The ornamental design for a dosage device for syringes,  
substantially as shown and described.

**DESCRIPTION**

FIG. 1 is a perspective view of a dosage device for  
syringes showing my new design;  
FIG. 2 is a front elevational view thereof;  
FIG. 3 is a top plan view thereof;  
FIG. 4 is a bottom plan view thereof;  
FIG. 5 is a right side elevational view thereof;  
FIG. 6 is a left side elevational view thereof; and  
FIG. 7 is a rear elevational view thereof.

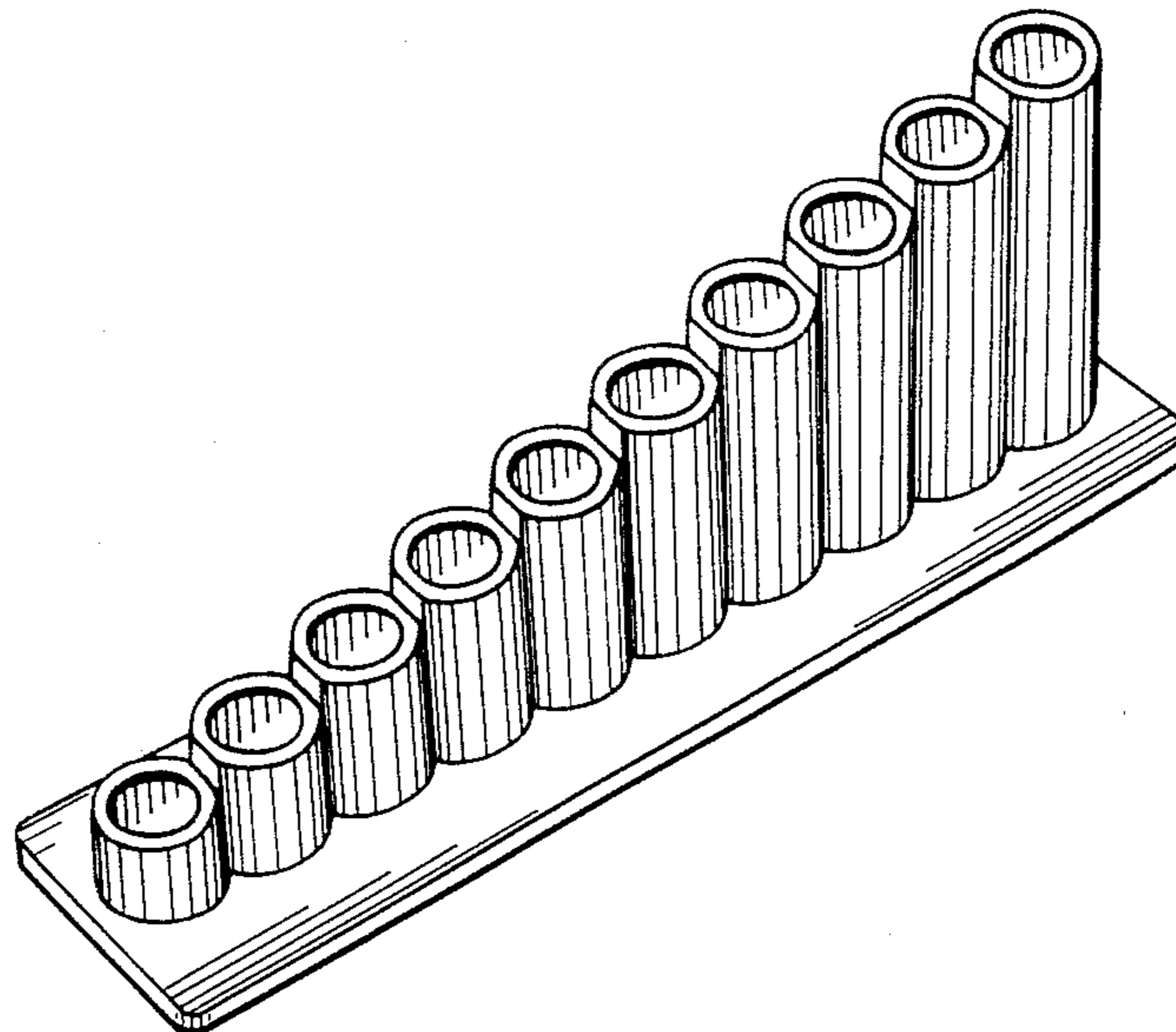

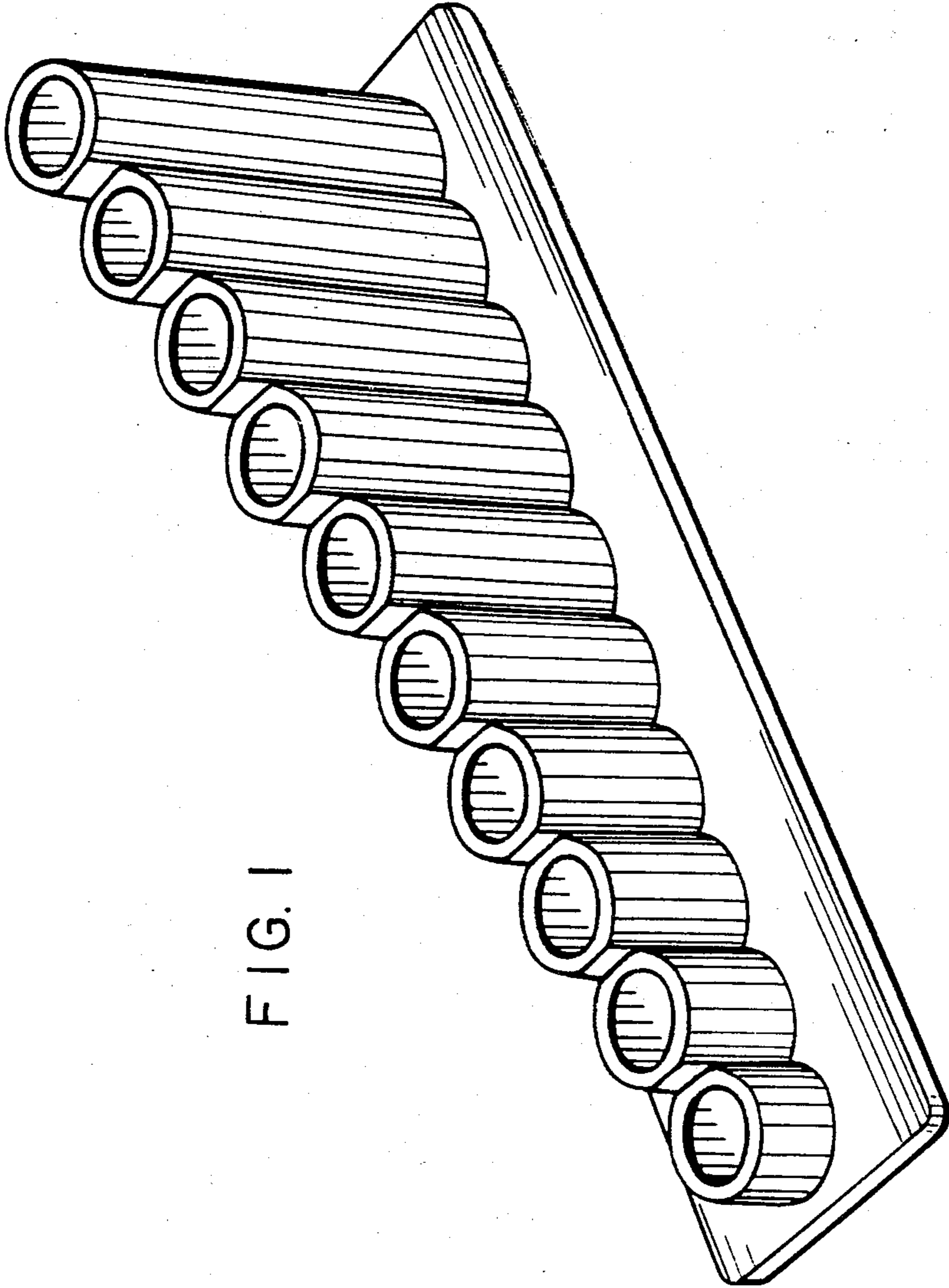

FIG. 1

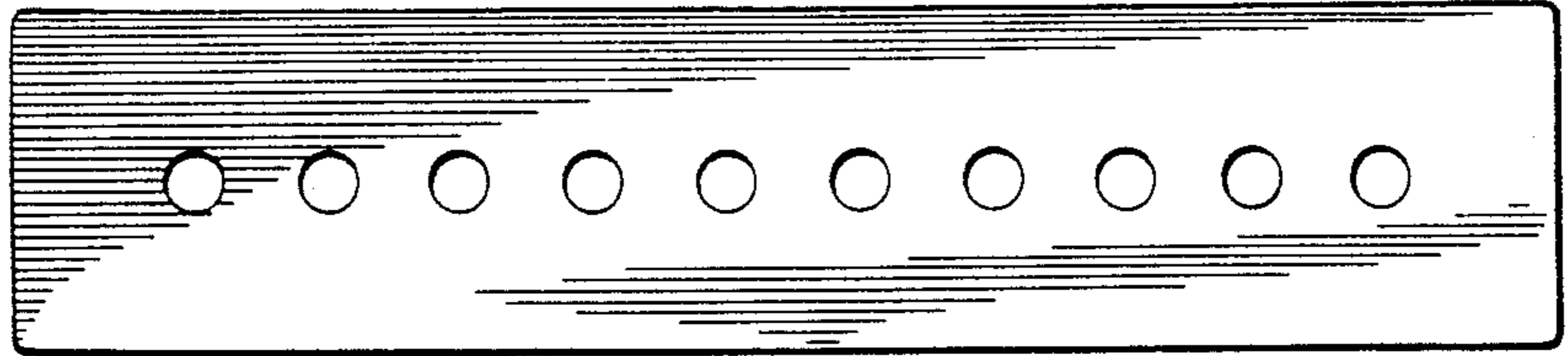

FIG. 4

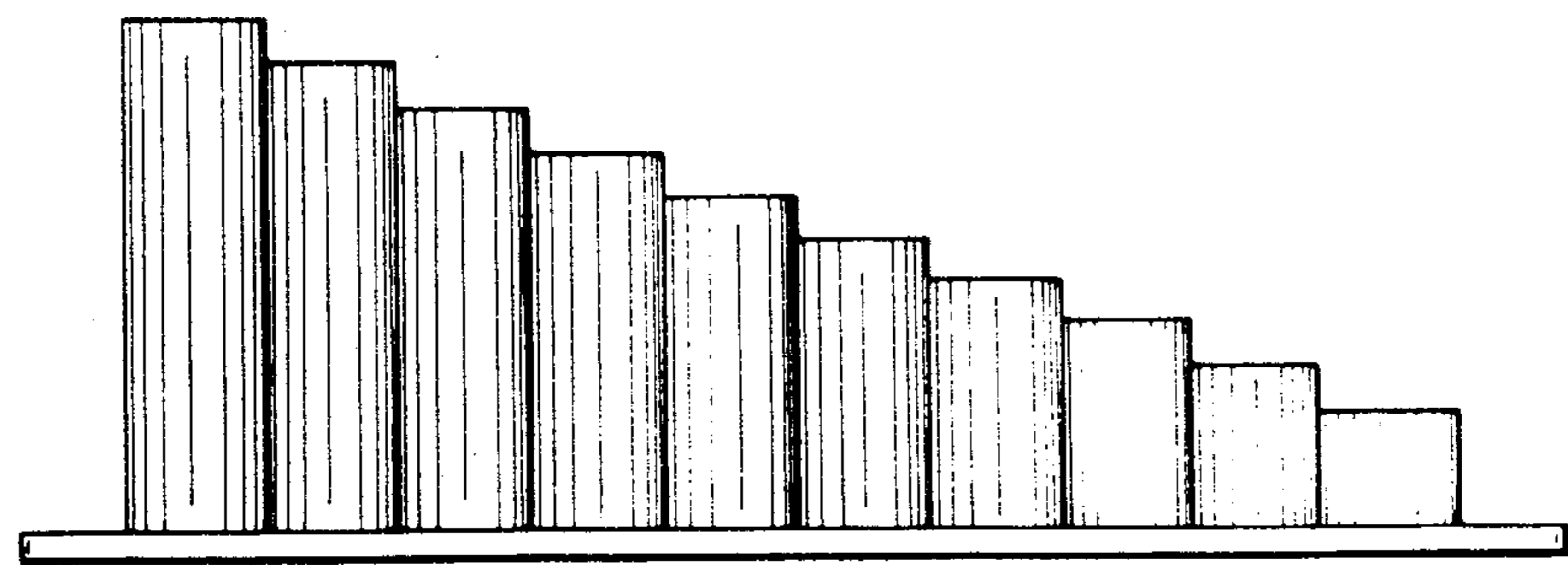

FIG. 2

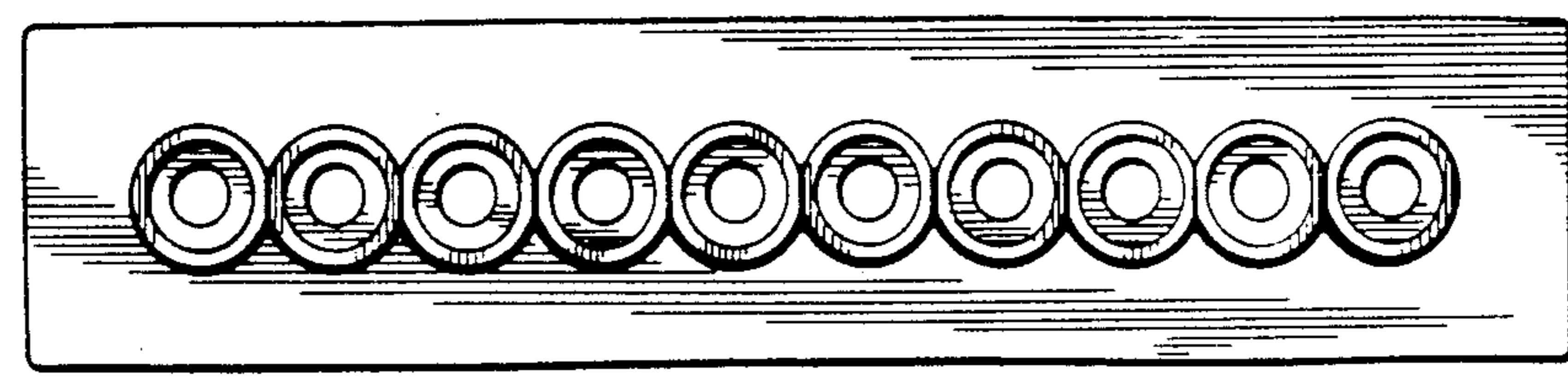

FIG. 3

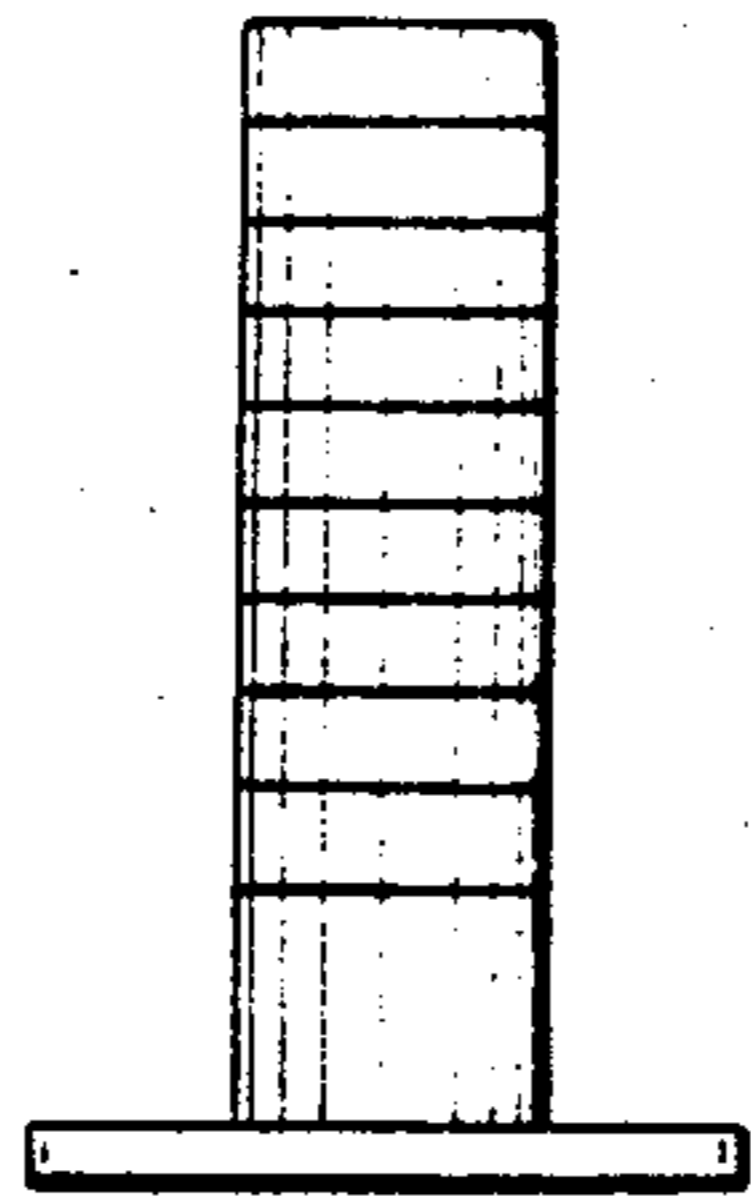

FIG. 5

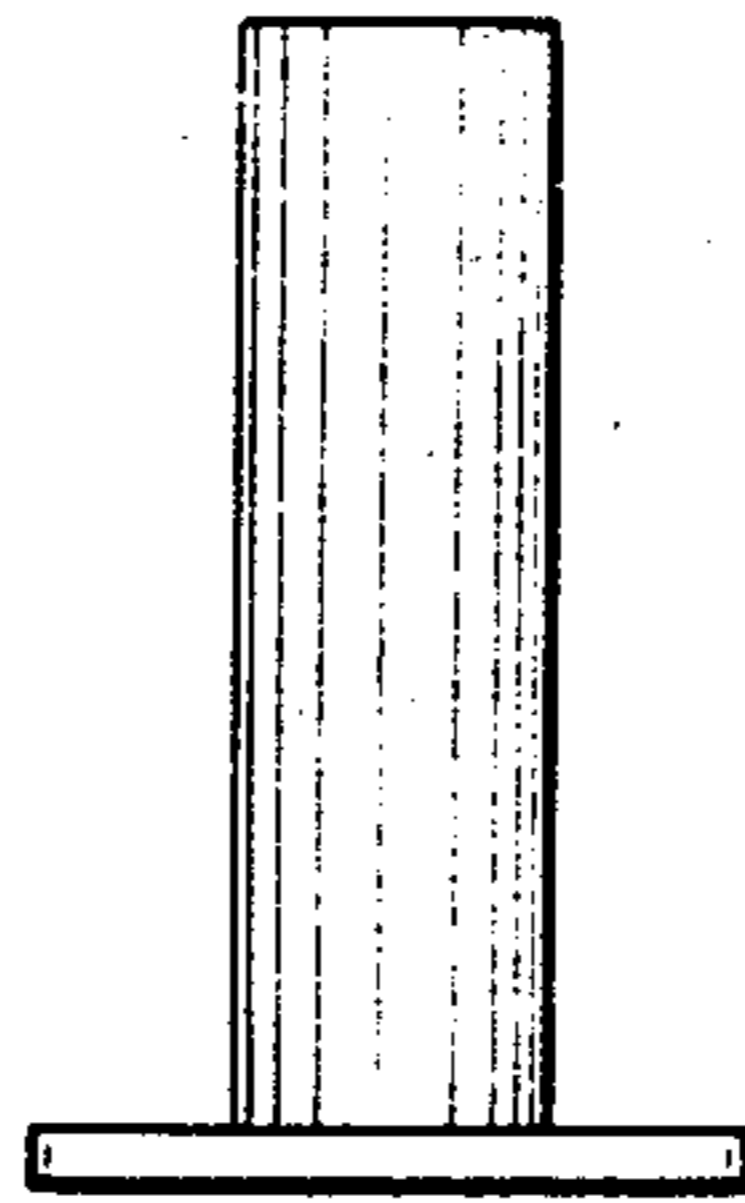

FIG. 6

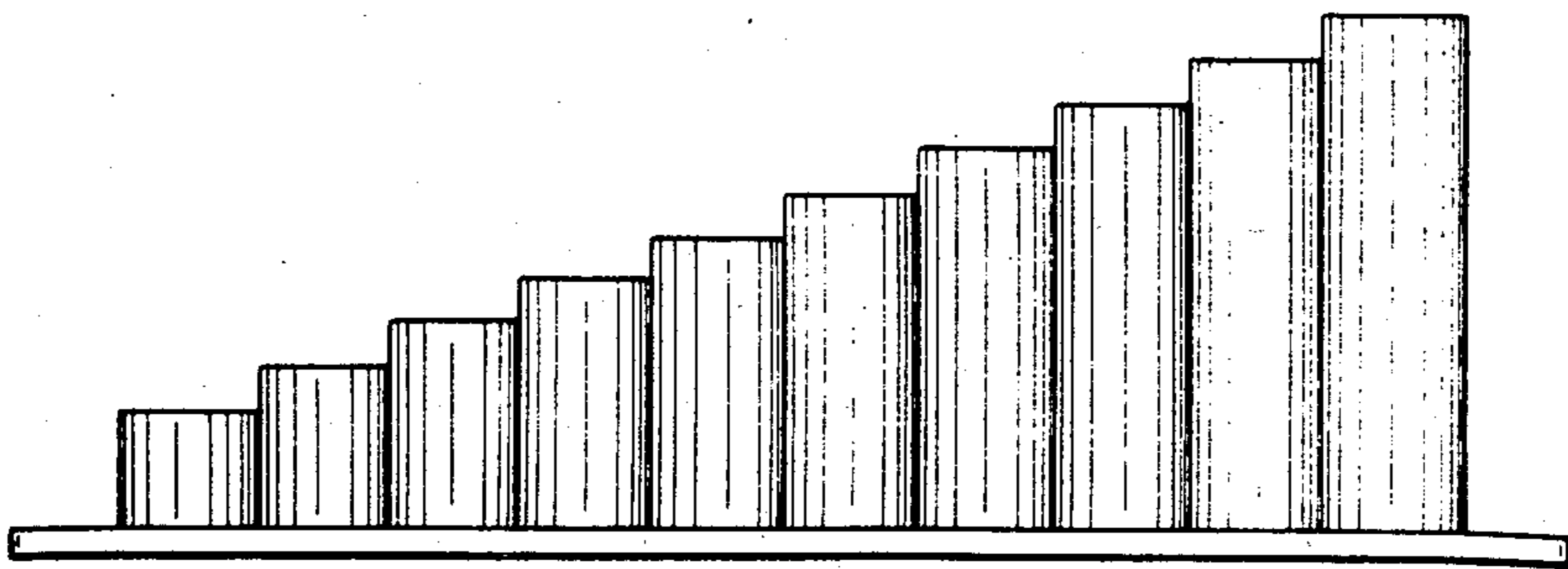

FIG. 7