

# United States Patent [19] Cellini

[11] Patent Number: **Des. 285,235**  
[45] Date of Patent: **\*\* Aug. 19, 1986**

[54] **PISTOL BARREL AND RECOIL REDUCER**  
[76] Inventor: **Vito Cellini, 3115 Old Ranch Rd.,  
San Antonio, Tex. 78217**  
[\*\*] Term: **14 Years**  
[21] Appl. No.: **615,224**  
[22] Filed: **May 30, 1984**  
[52] U.S. Cl. .... **D22/108**  
[58] Field of Search ..... **42/1 V, 63, 59, 75 B,  
42/77; D22/1, 6, 7, 8**

4,297,801 11/1981 Kahn ..... 42/59  
4,316,339 2/1982 Herriott ..... 42/59

*Primary Examiner*—A. Hugo Word

[57] **CLAIM**

The ornamental design for a pistol barrel and recoil reducer, as shown.

**DESCRIPTION**

FIG. 1 is a perspective view of a pistol barrel and recoil reducer, showing my new design.  
FIG. 2 is a side elevational view thereof.  
FIG. 3 is a top plan view thereof.  
FIG. 4 is a bottom plan view thereof.  
FIG. 5 is a front elevational view thereof; and  
FIG. 6 is a rear elevational view thereof.

[56] **References Cited**  
**U.S. PATENT DOCUMENTS**  
D. 185,374 6/1959 Liedke et al. .... D22/7

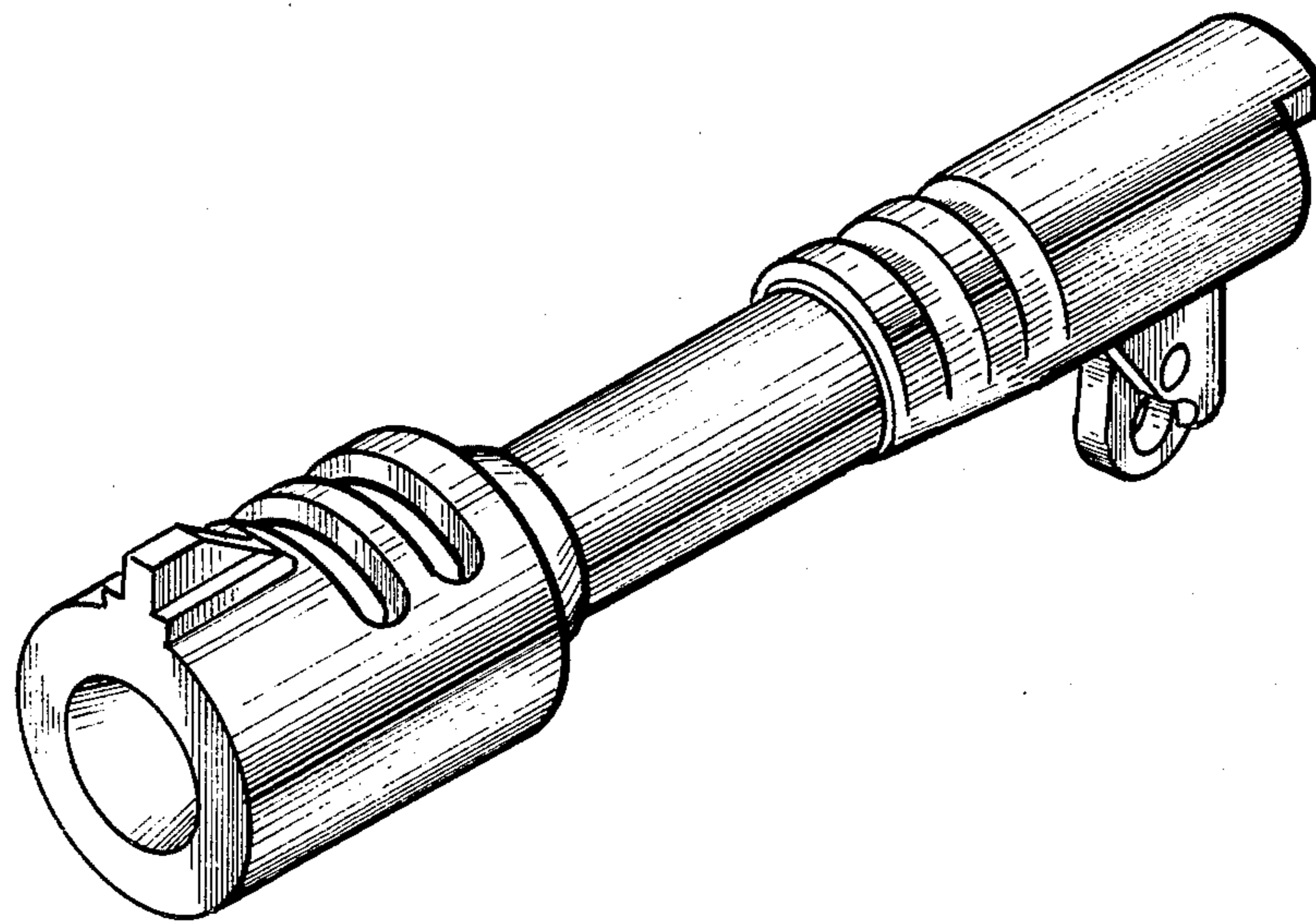

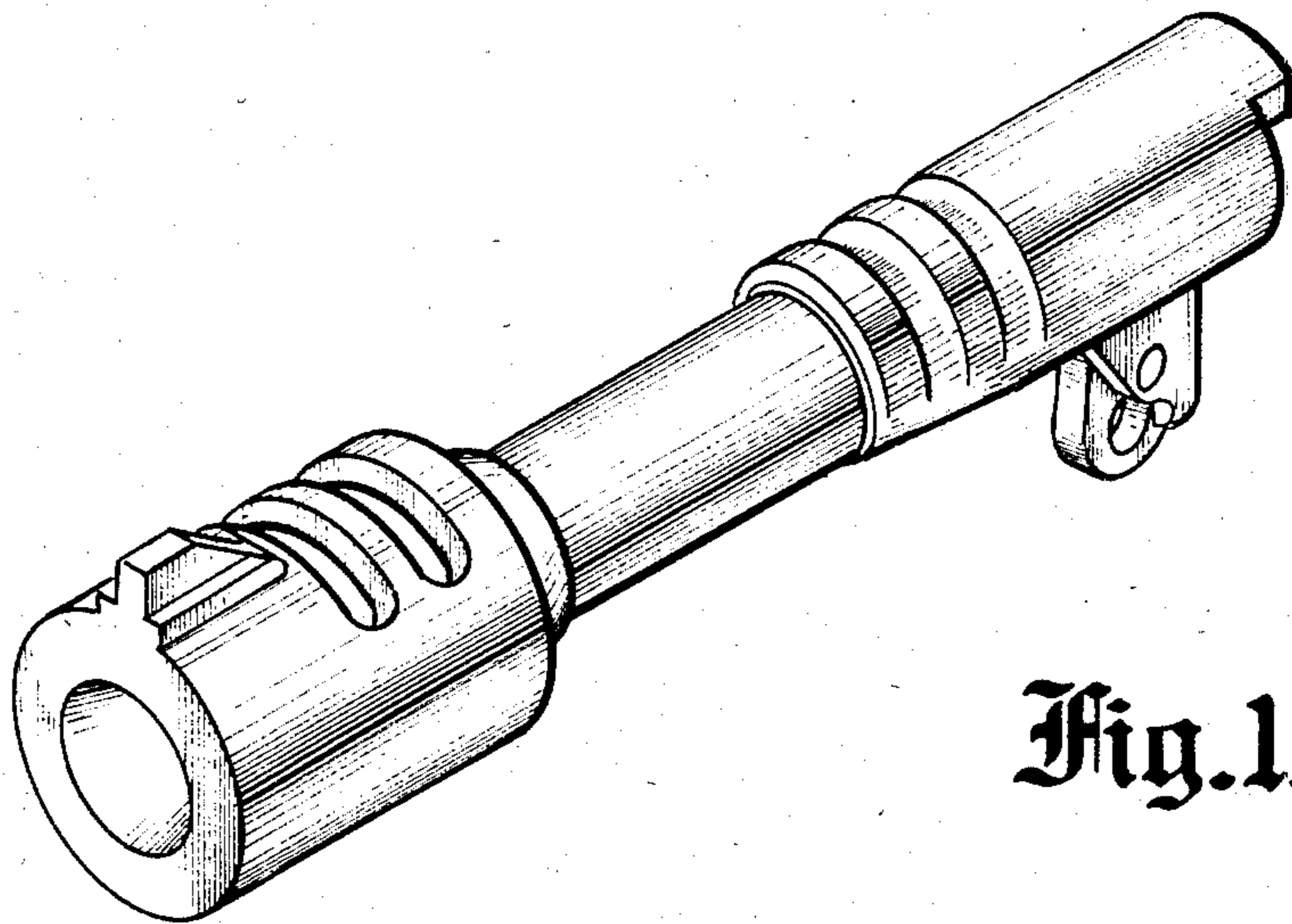

Fig. 1.

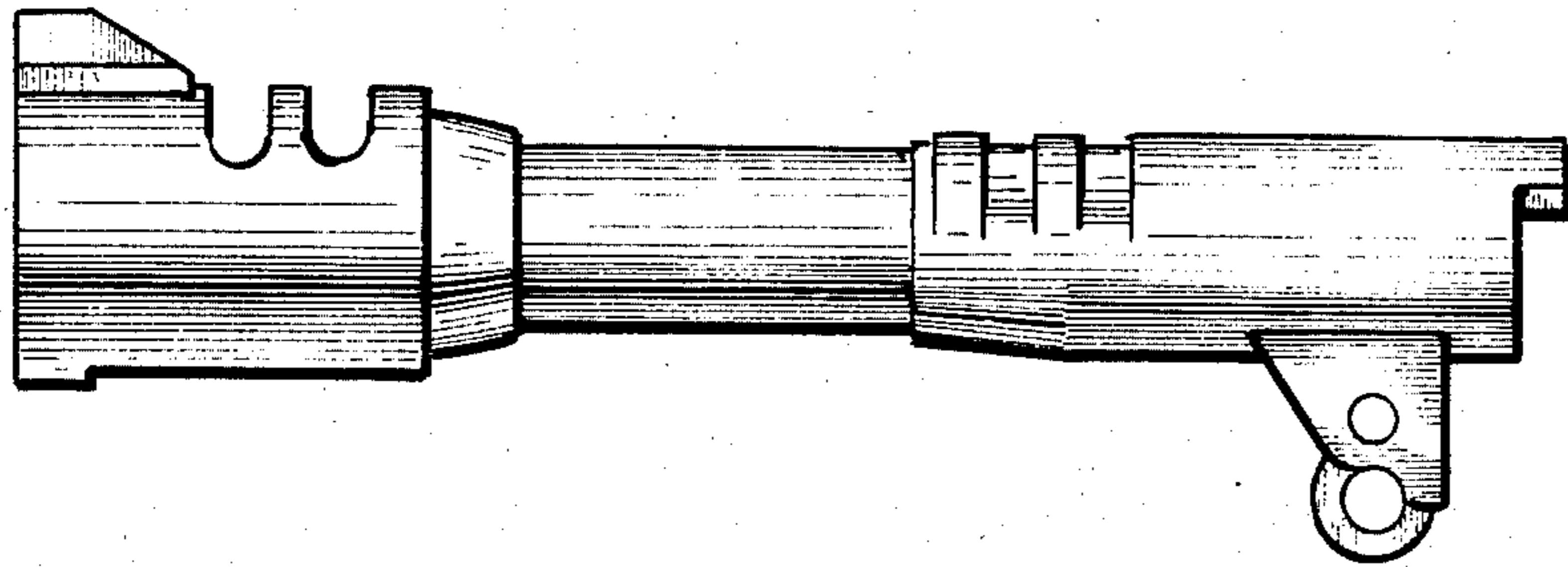

Fig. 2.

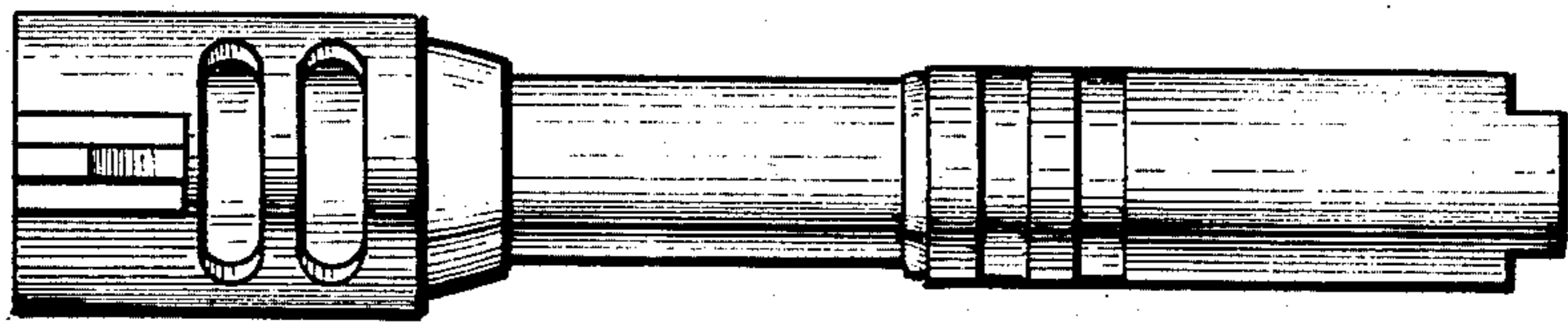

Fig. 3.

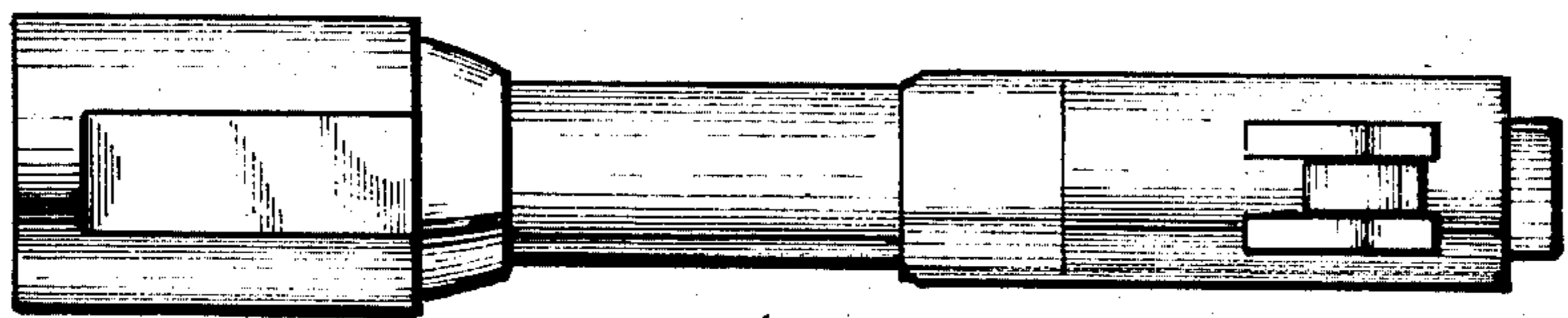

Fig. 4.

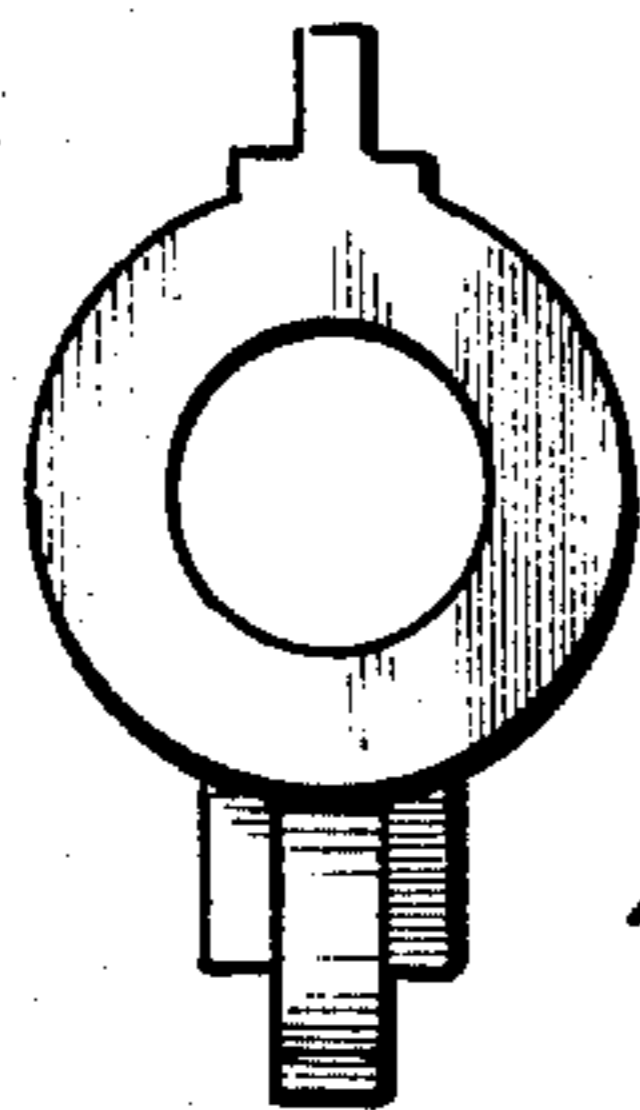

Fig. 5.

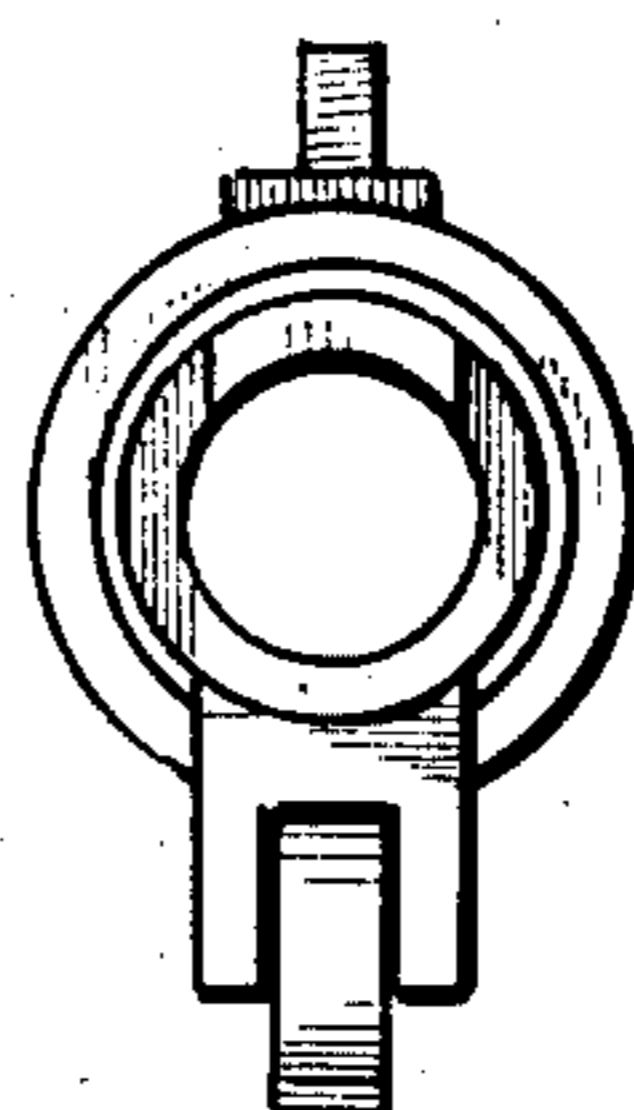

Fig. 6.